

ANNUAL REPORT

2015-2016



प्लाज़्मा अनुसंधान संस्थान

Institute for **Plasma Research**

Bhat, Gandhinagar 382428

GOVERNING COUNCIL

- | | |
|---------------------------|----------------------|
| 1) Shri Sekar Basu | Chairman |
| 2) Dr. D. Bora | Member |
| 3) Dr. Amit Roy | Member |
| 4) Shri K.N. Vyas | Member |
| 5) Dr. J. N. Goswami | Member |
| 6) Dr. Siraj Hasan | Member |
| 7) Smt.Chitra Ramchandran | Member |
| 8) Shri R. A. Rajeev | Member |
| 9) Shri Pankaj Joshi | Member |
| 10) Shri Sanjay Lal Bhai | Member |
| 11) Shri P. K. Atrey | Non-Member Secretary |

EXECUTIVE SUMMARY

The upgradation of Aditya tokamak from limiter configuration to divertor configuration tokamak is being carried out presently. It includes installation of many new subsystems such as poloidal magnetic field coils for divertor operation; a bakeable ultra-high vacuum vessel with a circular cross section instead of rectangular cross-section which was available before; a new bucking cylinder and with refurbishment of all existing toroidal magnetic coils to the maximum current. Power testing has been done successfully on all the installed sub systems, while the installation of vacuum pumps and diagnostic systems is in progress

In the Superconducting Steady-state Tokamak-1 (SST-1) the 1st phase of up-gradation with successful installation and integration of all its First Wall components has been completed. Repeatable ohmic discharges regimes having plasma currents in excess of 100 kA ($q_a \sim 2.8$, $B_T = 1.5$ T) with line averaged densities $\sim 0.8 \times 10^{19} \text{ m}^{-3}$ and temperatures ~ 200 eV with copious Magneto-Hydro Dynamics (MHD) signatures have been experimentally established. The next step will be further elongation of the plasma duration up to one second with position and density feedback as well as coupling of Lower Hybrid waves. The diagnostic systems are also being improved, with the addition of new diagnostics as well increasing the numbers of channels in existing diagnostics. After the installation of a new grill antenna for Lower Hybrid Current Drive (LHCD) systems, power has been successfully launched into the machine and preliminary results have been obtained

Various technologies required to realize fusion power are being indigenously developed under different heads. For the development of superconducting magnet technology, a dedicated facility has been established towards fabrication of fusion relevant long length cable-in-conduit-conductors of NbTi & Nb₃Sn with industry associates. Efforts are being continued in developing materials & fabrication technologies for Plasma Facing Components (PFCs), non-destructive evaluation/testing and high heat flux testing of PFCs and establishing/improving new test facilities. After successful demonstration of a prototype pellet injector in the laboratory, a single barrel pellet injector has been designed, fabricated and integrated with SST-1 tokamak. To deliver the Indian Lead Lithium Ceramic Breeder (LLCB) blanket and its associated ancillary systems to ITER project, many small experiments have been set up. The results from these experiments are being incorporated into the design of the deliverables. A Virtual and Augmented Reality Integrated Development lab (VARID-lab) is being set up.

For human resource development through a doctoral programme and for future technological developments, many small-scale experimental systems have been setup and are being utilized to their full potential. A robust programme continues in theory & simulation to better understand the underlying science in these experiments. This closely-connected programme of theory, simulation & experiment has also helped generate ideas for future experiments. A 35 Teraflop high performance computing facility, including some GPU-based servers, is in place to facilitate computational work.

The Facilitation Centre for Industrial Plasma Technology (FCIPT) continues to develop plasma technologies as well as facilitate the transfer of these technologies to industry, and for societal benefit. The projects cover various areas such as bio-medics, green power, textiles, waste management, nano-technology etc.

For ITER-India, most of the procurement packages have progressed into the factory testing phase, while some components have already been delivered to the ITER site. Manufacturing and factory testing are being done following international quality assurance and control standards, as is necessary for the ITER project. Various other R&D activities necessary are also being undertaken at the ITER-India laboratory in the IPR campus, and these sub-systems/components will be transferred to the construction site after due approval.

At the Centre of Plasma Physics, Guwahati, the commissioning of the CPP-IPR Magnetized Plasma Experiment for Plasma Surface Interaction (CIMPLE-PSI) has been successfully completed. The objective is to re-create ITER Divertor-like plasma with extreme hot ion flux, to be used for plasma material interaction experiments. Theory and simulation works in the centre are catering to other experimental activities at CPP-IPR.

DIRECTOR,
IPR.

ANNUAL REPORT

APRIL 2015 TO MARCH 2016

Since 1986 the institute has been involved in plasma physics research with fast growing facilities, trained man power and many fruitful national and international collaborations. Starting with small tokamak experiments and basic plasma experiments, the institute has been acquiring expertise in all the relevant scientific and technological requirements for controlled thermonuclear fusion. Through the participation of the country in the ITER project, technologies developed in the institute are being tested in the international arena. The activities of the Fusion Technology Development Programme under the past and current Five Year Plans are making good progress. Also the Center of Plasma Physics, Guwahati, has been well integrated with the programmes of the institute. The Facilitation Center for Industrial Plasma Technology (FCIPT) continues to make good progress with its mandate of plasma technology dissemination to industry & institutions.

CHAPTERS

A. SUMMARY OF SCIENTIFIC & TECHNICAL PROGRAMME	01
B. ACTIVITIES OF OTHER CAMPUSES	45
C. ACADEMIC PROGRAMME	62
D. TECHNICAL SERVICES	62
E. PUBLICATIONS AND PRESENTATIONS	62

CHAPTER A

SUMMARY OF SCIENTIFIC & TECHNOLOGICAL PROGRAMMES

A.1 Fusion Plasma Experiments	02
A.2 Fusion Technology Developments	10
A.3 Basic Plasma Experiments	29
A.4 Theoretical, Modelling & Computational Plasma Physics	39

A.1 Fusion Plasma Experiments

There are two existing facilities in the institute to do experiments related to fusion plasma, namely Aditya tokamak and Superconducting Steady-state Tokamak-I (SST-I). In this section the status of the device, new developments and details about the experiments done are given.

A.1.1 Aditya Tokamak

A.1.1.1 Upgrade and Status of the Device..... 02

A.1.1.2 Aditya Upgrade 04

A.1.2 Steady-state Superconducting Tokamak(SST-1)

A.1.2.1 Status of the Device & Experimental Results 05

A.1.2.2 Diagnostics Developments 07

A.1.2.3 Heating and Current Drive Systems 08

A.1.1 Aditya Tokamak

A.1.1.1 Upgrade and Status of the Device

The up-gradation of Aditya tokamak from limiter configuration to diverter configuration tokamak has been carried out this year. It includes installation of many new subsystems such as poloidal magnetic field coils for diverter operation, a bakeable ultra-high vacuum vessel with a circular cross section, bucking cylinder along with refurbishment of existing toroidal magnetic coils. The scientific objectives of Aditya tokamak Upgrade include low loop voltage plasma start-up

Aditya is the first indigenously built tokamak in the country and is operational since 1989. It has produced more than 100 internationally reputed journal publications and 9 Ph.D. theses.

with strong pre-ionization and having a good plasma control system. The same toroidal magnetic field coils and associated structure of the existing machine were used. The circular cross-section vacuum vessel enabled to accommodate the new set of poloidal magnetic field coils (diverter coils) for plasma shaping. The new vacuum vessel is made up of stainless steel 304L which can be baked up to 150° C and a base

pressure $\sim 10^{-10}$ Torr has been achieved in the test stands. The major steps in upgradation are described below.

Dis-assembly of existing machine: The Aditya tokamak has been dismantled up to base level is shown in Figure. A.1.1.1. It involved removal of various sub-systems viz., Diagnostic systems and pumping lines, top cooling water header and cooling connections, toroidal field (TF) coils, central transformer (TR) coils and vertical field (BV) coils systems with all their bus bar connections and their support structures, rectangular cross-section shaped vacuum vessel and its supports etc. The physical positions (radial, height and angular) of all magnetic field coils were recorded with Theodolite system before they dis-assembled and height measurement of all poloidal field coils (TR & BV) were transferred on a

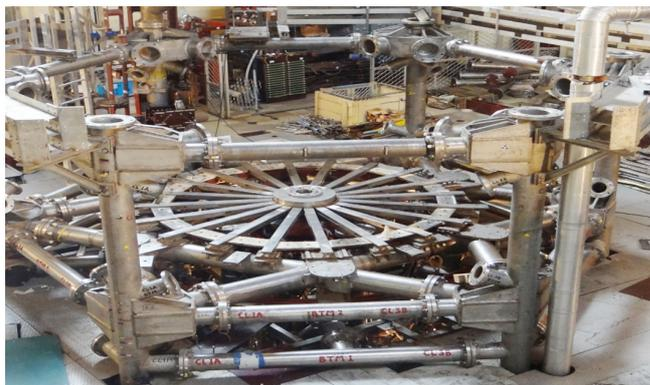

Figure A.1.1.1. Dis-assembly of Aditya Tokamak



Figure A.1.1.2. The photographs of damaged finger joints of Toroidal magnetic field coils

fixed reference with water level. The entire dis-assembly task was completed within 59 working days with ECDS measurements and marking of each and every components.

Refurbishment of damaged TF coils & outer body insulation of all magnetic field coils: During the dis-assembly of Toroidal magnetic field (TF) coils, it was realised that some of the TF coils as shown were damaged (as shown in Figure A.1.1.2). The copper material have been melted and eroded mainly at the edges of fingers joints of small -C and big C of TF coils especially in the middle fingers. These damaged coils were refurbished using in-house techniques. Then they were assembled one by one on Test Stand by joining both C's sections and the electrical parameter testing (Resistance and Inductance) of these coils have been carried out. The measured values of all coils were within satisfactory limits and were in good condition to be reused again. One of the possible reason of these damages is that the TF coils finger joints fasteners are impossible to tighten in presence of guiding wedge block, while machine is fully assembled. During disassembly of TF coils, it was found that many of the finger joint fasteners of TF coil were completely loosen and did not require even spanner to open. Henceforth to avoid this, all 20 nos. of TF coils finger joint fasteners has been tightened with Nord-Lock washers. The outer body insulation of TF, TR and BV coils with its busbar connections has been successfully completed before they are assembled on the machine. The TF, TR, BV, main diverter, auxiliary diverter and FFB coils insulation has been tested by applying meggar voltages and found satisfactory.

Vacuum Vessel and related activities: One of the important modification in the upgradation of Aditya tokamak is the re-

placement of the rectangular cross section vacuum vessel by circular cross section with vessel baking facility. as shown in the figure A.1.1.3. The cross section of vessel has been designed as circular to accommodate eight vertical field coils including main divertor coils (4 Nos.), Auxiliary Divertor Coils (2 Nos.), Fast feedback coils (2 Nos.) in the available space between circular vessel and toroidal field coils. The new toroidal vacuum vessel has been designed with two semi-tori having electrical isolation at two junctions. The major radius (0.75 m) and minor radius (0.25 m) has been kept same as of old torus. In order to accommodate as many numbers of diagnostics as possible, the vessel has been designed to have 112 port openings (including four Tangential Ports) compared to 48 ports of the old vessel. The shell formation and fabrication for torus, leak proof, UHV condition, precise dimensions and lots of weld and demountable joints in the new vessel had made the fabrication job very challenging. It has been precisely fabricated as per IPR design by a vendor under the supervision of IPR scientists. The final acceptance tests have been carried out at IPR premise successfully as results of local helium leak rate $< 5 \times 10^{-10}$ mbar.l/s and global leak rate $< 5 \times 10^{-8}$ mbar.l/s, UHV test as vacuum achieved less than 9×10^{-10} mbar in the vessel, vessel baking $\sim 150^\circ$ C for 100 Hrs. After external testing, the vessel has been installed and assembled successfully. After Installation the vessel has been tested for leak proof assembled as $< 1 \times 10^{-9}$ mbar.l/s and electrical isolation > 5 KV between two semi torus.

Integrated power testing of Aditya Upgrade tokamak: The re-assembly of Aditya Upgrade tokamak has been successfully completed (please refer figure A.1.1.4). The coils are accurately positioned within an accuracy of ± 2 mm using ECDS. The busbar connections of all the coils (new and

old) are assembled and clamped with proper supports. After connecting the cooling circuits, the cooling connections were tested with demineralized water at 1.5 kg/cm² inlet pressure. The TF, TR and BV coils are successfully charged during integrated power testing. The TF coil assembly has been tested ~ 1.5 Tesla, The Ohmic coil assembly has been tested ~ 12.5 kA (Loop Voltage ~ 20 V), The Vertical coil assembly has been tested ~ 3 kA. The TF coils displacement, fault current monitoring and magnetic field measurements were carried out during current charging. The movement of outer vertical leg of TF coils was recorded below 0.2 mm at full TF current. There was no fault current observed during the test. All the CTC conductor based coils (main Diverter coils, Aux. Diverter coils, outer diverter coils, FFB coils and single turn correction coils) are successfully heated up to 120° C for insulation curing purpose.

Development of Electronics systems for Aditya upgrade:

Plasma current of as high as 160 kA and temperature well above 5 million degrees were obtained for almost quarter of a second with 1.26 Tesla of toroidal magnetic field. After 25 years of operation, it has gone through a major upgrade and is expected to be operational soon

Up gradation and retrofitting of Electronics and Instrumentation for Aditya upgrade include, design and modification in diagnostic electronics, induction of programmable logic controllers for vacuum control, design of electronics for APPS control signal and 64 channel in-house developed Data acquisition board. Apart from the electronics for many diagnostics has been redesigned for better performance with latest available components and technology. Procurement for PCB fabrication, EMC/EMI protected Racks & Chassis, Components, Connectors and power supplies are in process.

A.1.1.2 Heating Systems

Lower Hybrid Current Drive (LHCD): The upgradation of Aditya tokamak provides an opportunity to upgrade lower hybrid current drive (LHCD) system also which can drive plasma current non-inductively and enhance the coupling of RF power to the plasma. It is proposed to replace existing grill antenna by a new type of antenna which is often referred to as passive active multi-junction (PAM) antenna. The existing high power klystron based radio frequency source (3.7 GHz, 500 kW CW) would be used to power the new PAM antenna. The PAM antenna has an advantage of providing efficient rf coupling to the plasma, even at edge densities close to cut-off. Further it provides a lower reflection from the plasma as compared to the conventional grill antenna. The design of various rf components at 3.7 GHz. have been undertaken.



Figure A.1.1.3. Circular cross-section vacuum vessel in the test stand at the institute

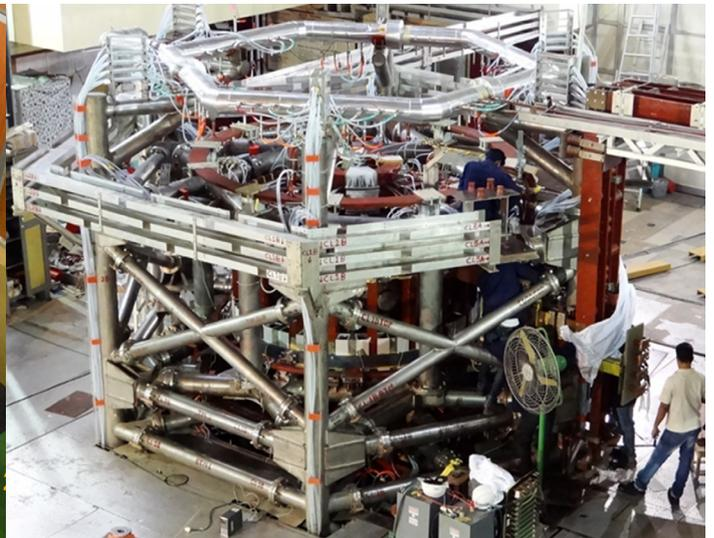

Figure A.1.1. 4. Re-assembly of Aditya Upgrade Tokamak in the advanced stage

A.1.2 Superconducting Steady-state Tokamak (SST-1)

A.1.2.1 Status of the Device and Experimental Results

This experiment has made significant progress both on enhancing the parameter space of operations as well as up-gradations of its core sub-systems. SST-1 completed the 1st phase of up-gradation with successful installation and integration of all its First Wall components. The First Wall comprises of ~ 4500 high heat flux compatible graphite tiles being assembled and installed on 130 CuCrZr heat sink back plates engraved with ~ 4 km of leak tight baking and cooling channels in five major sub groups equipped with ~ 400 sensors and weighing ~ 6000 kg in total in thirteen isolated galvanic and six isolated hydraulic circuits. The phase-1 up-gradation also included addition of Supersonic Molecular Beam Injection

(SMBI) both on the in-board and out-board side, installation of fast reciprocating probes, adding some edge plasma probe diagnostics in the SOL (Scrape Off Layer) region, installation and integration of segmented and up-down symmetric radial coils aiding/controlling plasma rotations, introduction of plasma position feedback and density controls etc. Post phase-I up-gradation, a robust First Wall baking system assisted with hot Nitrogen and capable of baking the plasma facing components in excess of 300°C over long duration has been established. In order to make the SST-1 Poloidal Field (PF) Magnets superconducting, an elaborate modification in the 'integrated flow distribution system' to various similar groups of hydraulic paths of the superconducting magnets system have also been carried out. After initial engineering validations of the up-graded SST-1 that included establishment of 10^{-8} mbar order vacuum inside the vacuum vessel and helium based 'glow discharge cleaning;'. Initial plasma

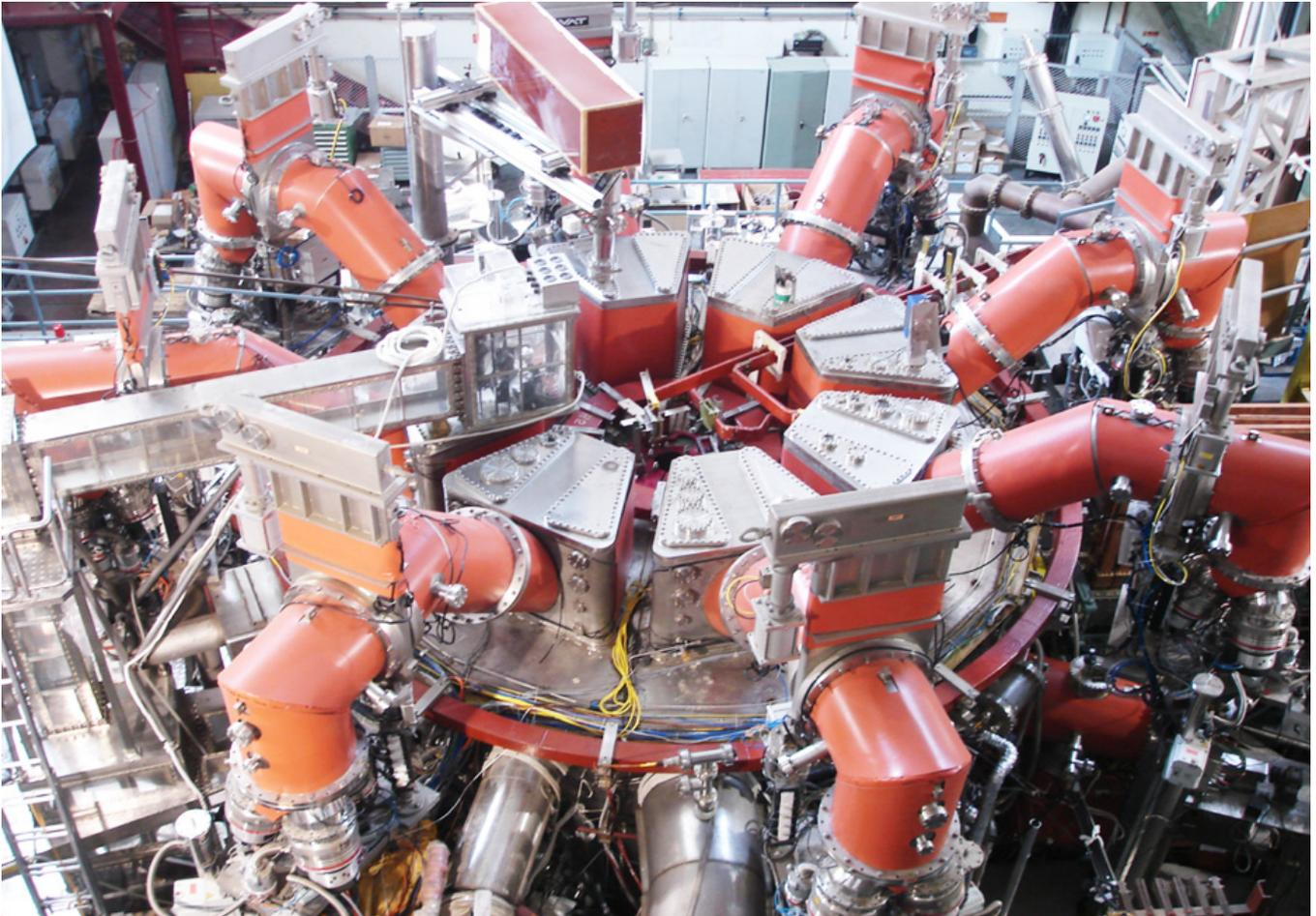

Figure A.1.2.1.1 Refurbished Steady State Superconducting Tokamak (Top View)

7607 EDDY B-Field 30 ms

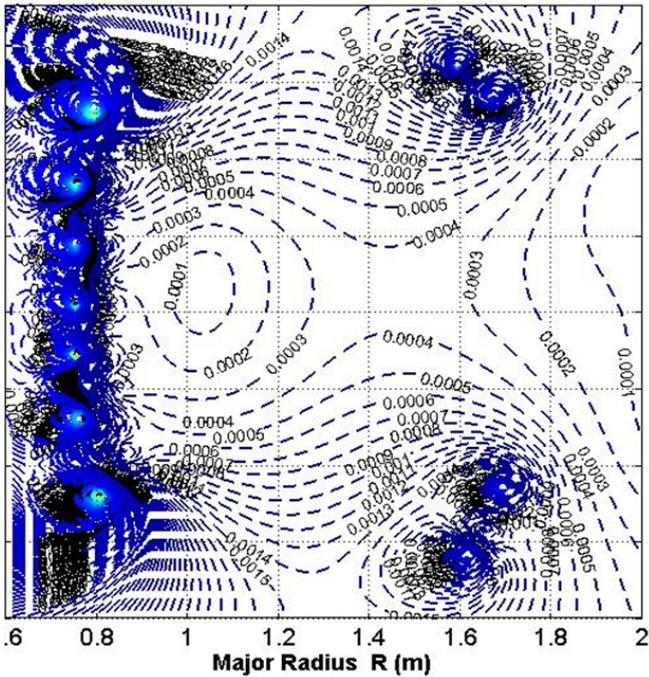

Figure A.1.2.1.2 Constant Flux contours of SST-1

SST-1 is a medium size superconducting tokamak, which has been designed and built to study the physics of the plasma processes in tokamak under steady-state conditions.

experiments in up-upgraded SST-1 have begun since August 2015. The first experiments in SST-1 have revealed interesting aspects on the ‘eddy currents in the First Wall support structures’ influencing the ‘magnetic Null evolution dynamics’ and the subsequent plasma start-up characteristics after

The first stage of upgradation has been completed with carbon-carbon composite plasma facing components and 80K liquid nitrogen booster system with integrated flow distributions etc.

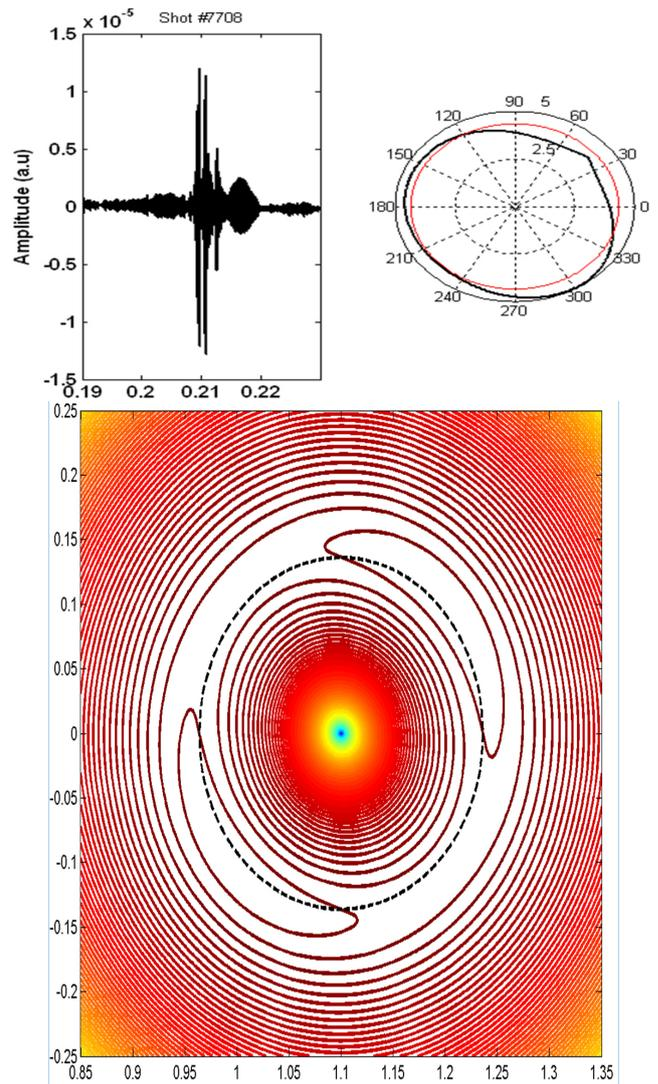
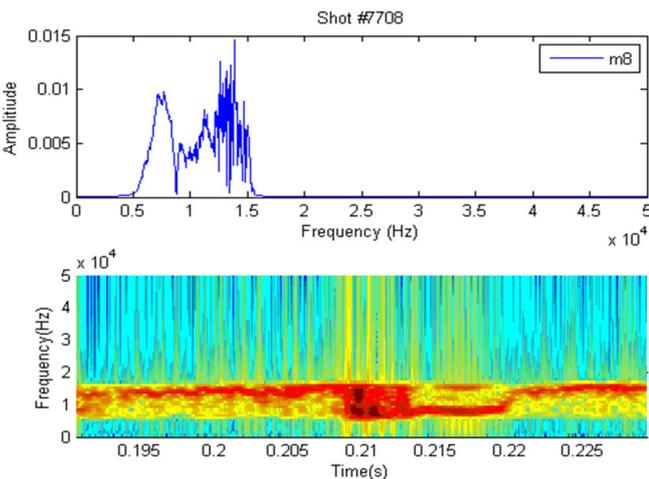

Figure A.1.2.1.3 MHD characteristics in SST-1 Plasma shots



the ECH pre-ionization, the influence of the first walls on the ‘field errors’ and the resulting locked modes observed, the magnetic index influencing the evolution of the equilibrium of the plasma column, low density supra-thermal electron induced discharges and normal ohmic discharges etc. Presently, repeatable ohmic discharges having plasma currents in excess of 100 kA ($q_a \sim 2.8$, $B_T = 1.5$ T) with a current ramp rates ~ 1.2 MA/s over a duration of ~ 500 ms with line averaged densities $\sim 0.8 \times 10^{19} \text{ m}^{-3}$ and temperatures ~ 200 eV with copious MHD signatures have been experimentally established. Further elongation of the plasma duration up to one second or more with position and density feedback as well as coupling of Lower Hybrid waves are currently being pursued in SST-1 apart from increasing the core plasma parameters with further optimizations and with wall conditioning.

A.1.2.2 Diagnostic Developments

Soft x-ray diagnostics: This diagnostics based on foil ratio intensity measurement is used to measure Electron temperature (T_e) of hot core tokamak Plasma. In SST1 this diagnostic is used with some design modification to measure the first T_e at lower plasma density although the modification reduces the accuracy to some extent. The chord averaged electron temperature measured for SST1 plasma varies from 90 to 230 eV for different shots for plasma current $I_p \sim 40$ kA to 75 kA.

Lanthanum-Bromide detector Spectrometer: LaBr based Hard x-ray spectrometer was installed and the measured spectrum from SST1 shows maximum runaway flux during discharge emitted in the range of 150-200 keV.

High energy beam erosion on material study in SST1: Some high energy beam interaction or sputtering on surface of srx detector chamber is observed. The energy of beam and depth of erosion is measured. The beam energy calculated for the depth of 12-15 μm was around 6-8 keV. Further study is going on.

Infrared Thermography (IRT) of Plasma Facing Components: Infrared Thermography of Plasma Facing Components (PFCs, namely Limiter, Diverter, stabilizer plates etc.) is one of the most essential tools to investigate plasma-surface interaction and to estimate power loss through this interaction. The information obtained through this diagnostic is useful for machine protection, plasma control and for physics studies.

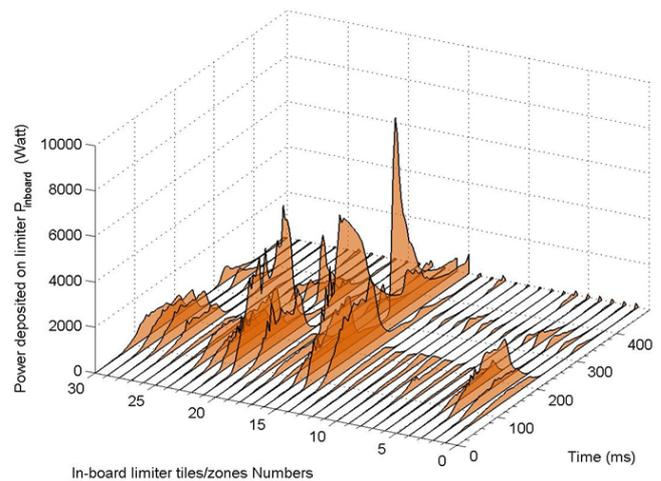

Figure A.1.2.2.1 Temporal Evolution of power deposited on inboard limiter tiles/zones

During the reporting year, statistical analysis of plasma discharges were carried out for experimental campaign – VII to XI and typical power loss through limiter plasma interaction was estimated as shown in figure. The information was also useful for machine protection, plasma operation & control point of view as well as for physics studies. Statistical analysis showed typical power loss due to limiter-plasma interactions and the results can be useful for power balance studies.

Tangential viewing IRVB system installed on the SST-1 Tokamak: Different R & D activities related to the up-gradation of the IRVB system for the SST-1 tokamak were carried out during the reporting period that also includes modifications, re-installation of the system after up gradation of SST-1 machine with First Wall components and maintenance of the diagnostic etc. Operations of the IRVB system installed on the SST-1 Tokamak for different experimental campaigns held during the reporting period and data analysis were performed. Modifications in the signal estimation model (synthetic diagnostic) and data analysis scheme were made. A detailed report has been prepared and submitted for review). In addition, FEM simulation work has been performed to validate all numerical schemes used for the data analysis with simulated results. A good agreement have been found between input FEM power profile and re-generate power profile with numerical schemes that we are using for the IRVB data analysis .

Infra Red Video Bolometer (IRVB) System: This IRVB

diagnostic system installed on the SST-1 tokamak has provided its first results at very low signal level emission. This achievement shows that the design of the system was made efficiently to detect low signal levels. The expected signal level in the SST-1 tokamak is found to be very small, that imposed challenges in designing the diagnostic and to overcome other sources of noise. In addition, we found reasonably good agreement between the modeled IRVB radiation pattern and experimental radiation pattern.

Detection of synchrotron radiation emitted by “Runaway Electrons” using IR-Camera: “Runaway Electrons” (REs)

While a lot of experiences have been gained through operating various diagnostics for Aditya tokamak, translating those experiences to a steady state machine like SST-1 is very challenging. Those challenges have given many more valuable experiences to the scientists working here.

are produced inside the tokamaks during different phases of a plasma discharges based on experimental conditions and plasma parameters. These REs are high energetic electrons typically in mega electron volts (MeVs). Experimental observations and detection of Runaway Electrons (REs) is very important for many reasons namely physics studies, machine protection and plasma control for mitigation of RE generation. Several active and passive diagnostic methods are available for the detection of confined and de-confined REs. One of the establish method is HXR monitor. However, this method is indirect and estimation of REs confined current is difficult and requires certain assumptions. Another interesting and quite establish method is detection of synchrotron radiation (which typically fall in infrared range/visible range) emitted by REs when they are still confined inside the plasma column. Infrared Camera can detect forward synchrotron emission from REs, if the camera is configured in electron approach tangential viewing direction. The diagnostic was deployed in SST-1 to during the reporting period.

Charge Exchange Neutral Particle Analyzer (CX-NPA): The diagnostics aims to measure the core ion temperature of

plasma in Aditya as well as in SST-1 based on its passive mode of operation. It uses retarding electrostatic field to separate the energy components of the CX- neutrals (ionized after its exit from stripping cell) escaping from plasma. The diagnostics has been operation during recent SST-1 campaigns.

A.1.2.3 Heating and Current Drive Systems

Electron Cyclotron Resonance Heating (ECRH) System:

The 42GHz/500kW Electron Cyclotron Resonance Heating (ECRH) system has emerged as a main system for SST-1 tokamak and extensively used to start-up the tokamak. The ECRH launcher has been modified successfully to accommodate the 42GHz and 82.6GHz systems along with hard X-ray diagnostics. The system is successfully commissioned on tokamak and high power test are carried out up to 325kW power with new launcher. After the refurbishment of SST-1 with all in vessel components, the 42GHz-500kW ECRH system has been used as a routine system for SST-1 tokamak start-up. The SST1 is operated to 1.5T operation and ECRH power (200kW to 250kW) in fundamental O-mode is launched from low field side of tokamak. The power is launched around 10ms before the loop voltage. The pulse duration is varied from 100ms to 200ms. The consistent breakdown assisted with ECRH is achieved in SST1 tokamak with longer shots with plasma current more than 100 kA. The PXI based DAC system has been procured and delivered and commissioned at IPR. The system has been tested successfully with real field signal. The GUI with required software is developed in lab-view. The system would be integrated with ECRH system for SST-1 operation.

Lower Hybrid Current Drive (LHCD) System: The newly fabricated SS grill antenna has been tested and has been installed on the machine. The joints of the grill antenna, vacuum window and in-vessel module are made and joints sealing is tested for UHV compatibility. Thermocouples are installed at several locations near the sealing joints of the grill antenna to monitor the temperatures when baking of PFC components is carried out. The cooling line connections are made in-situ for the grill antenna and the weld joints are qualified for pressure test as well as for UHV leak test. The photograph of the SS grill in SST1 machine is shown in figure A.1.2.3.1. After successful baking, the LHCD antenna system showed no leaks and confirmed maintenance of UHV



Figure A.1.2.3.1 Stainless Steel Grill Antenna for LHCD launching in SST-1

compatible seal joints. To feed more LH power in the coming campaign, all the rf components in layer-3 and layer-4 are installed and integrated. The inter-connecting waveguides are fabricated and successfully installed so that layer-3 and layer-4 are connected to grill antenna. With the completion of this integration work of layer-3 and layer-4, all the four layers stand fully installed. A photograph of the assembly is shown in figure-A.1.2.3.2. The integration of other two klystrons which would be feeding power to layer-3 and layer-4 is also successfully completed. A photograph showing all the klystrons installed in the high power section is shown in figure-A.1.2.3.3. The parallel operation of multi klystrons system using single regulated high voltage power supply (RHVPS) is carried out. One second operation is successfully carried out using bleeder resistance with all the modules (65 in numbers) connected in the circuit. However this operation is limited to one second only due to power rating of bleeder resistor. Once the operation of klystron with RHVPS is established without bleeder resistor, all the four klystrons are operated in parallel mode with RHVPS simultaneously with rf power dumped in to water cooled dummy loads. From campaign-XIII onwards, the LHCD power has been successfully launched in to the SST1 machine and encouraging results have been obtained. When LHW's are launched, it imparts momentum to energetic electrons and generates supra-thermal electrons which give rise to plasma current and the loop voltage drops. Beyond a threshold value, an instability sets in and due to pitch an-



Figure A.1.2.3.2 The layer-3 and layer-4 components are installed with the inter-connecting waveguides

For SST-1, all the three types of Radio-Frequency based heating and current drive systems ECRH, ICRH and LHCD are operational now.

gle scattering, the toroidally flowing electrons (passing electrons) gets scattered into perpendicular direction and results in loss of current. This leads to increase in loop voltage. The above cycle repeats and explains the spikes observed in loop voltage with LH power.



Figure A.1.2.3.3 A photograph showing all the four klystrons

A.2 Fusion Technologies Development

Under Continuing five year plans, various technologies related to fusion are being developed under the following heads :

A.2.1 Magnet Technology.....	10
A.2.2 Divertor & First Wall Technologies.....	11
A.2.3 Pellet Injector System	14
A.2.4 Test Blanket Module (TBM)	15
A.2.5 Large Cryogenic Plants & Cryo-systems (LCPC).....	18
A.2.6 Remote Handling & Robotics Technology.....	20
A.2.7 Negative Ion Neutral Beam System.....	23
A.2.8 Fusion Reactor Materials Development & Characterization.....	24
A.2.9 Fusion Fuel Cycle.....	25

Brief details about the progress made in the report period is given in this section.

A.2.1 Magnet Technology

This programme caters to the development of different magnets which will be used in a fusion machine. A dedicated facility has been established towards fabrication of fusion

Magnet technology is one of the important requirements for the magnetically confined tokamak plasmas. Apart from catering to domestic experiments, this activity is collaborating internationally also for e.g. ELM coil of JET which is a big tokamak at Oxfordshire, UK

relevant long length cable-in-conduit-conductors of NbTi & Nb₃Sn with industry associates. In this facility nearly 1100 m of long cabling has been completed for the central solenoid magnet of the Steady State Superconducting Tokamak. Intermediate novel superconductor MgB₂ based long lengths of high performance mono-filament and multifilament strands and state-of-the-art superconducting joints have been realized. With these achievements, a number of cryogenics sav-

ing applications namely for overloaded current leads and edge localized coils (ELM) in Tokamak applications would be feasible as the operating conditions will be in cold helium gas at 20 K. Indigenous development and validation of solid nitrogen based superconducting short samples characterization facilities has also been achieved. During this period, the high temperature (> 350 °C) compatible insulation resin infusion system for magnets operating at high temperature environments in a Tokamak has also been successfully realized. These insulation systems have been extended towards the 1:1 ELM coils of the Joint European Torus (JET) realization under IPR-UKAEA JET international collaborations successfully. With close collaboration with Indian industries, the winding of ELM magnets for large JET like Tokamak, encasing and vacuum pressure impregnation related processes and technologies have also been successfully developed and validated. These prototype magnets have been experimentally validated in representative operating as well as off-normal conditions.

Magnet for Gyrotron : For the first time in the country, Magnet Division has realized the complex high homogeneity superconducting cavity magnet system together with a low loss cryostat and necessary quench protection measures. These magnets have successfully operated for long durations (> 4



Figure A.2.1 Nb₃Sn cabling for SST-1 superconducting Central Solenoid

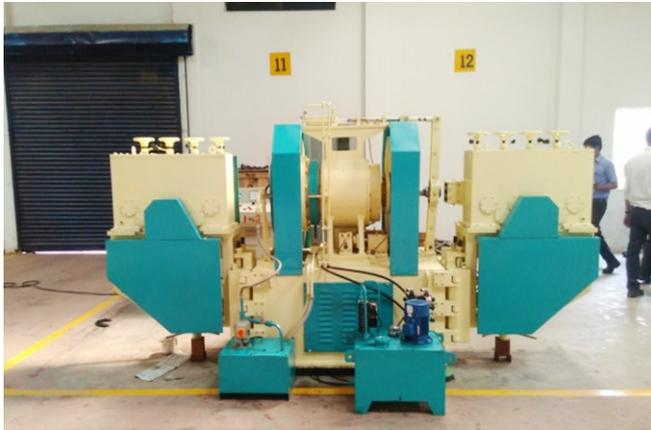

Figure A.2.2 Jacketing Facilities and trials there in

hours) of gyrotron testing. On the protection of high current carrying high field magnets, a new technology of 'hybrid breaker' using parallel IGBTs have been successfully demonstrated. These technologies can now be extended towards

the protection of fusion relevant magnets system in Tokamak.

A.2.2 Divertor & First Wall Technology

This programme deals with research and development of the materials & technologies relevant to Plasma Facing Components (PFCs) viz. Divertors and First-wall Components, for fusion grade tokamaks. Efforts were continued in developing materials & fabrication technologies for PFCs, non-destructive evaluation/testing and high heat flux testing of PFCs and establishing/improving new test facilities. Major activities includes: (a) Integrating and improving new Data Acquisition & Control System (DACS) with all subsystems of High Heat Flux Test Facility (HHFTF), (b) Performing high heat flux testing of tungsten mono-block test mock-ups with uniform and non-uniform heat loads, (c) Performing high heat flux testing and thermal cyclic fatigue testing of tungsten coated



Figure A.2.3 Test set up for 1.65 T Gyrotron Magnet

copper & SS test mock-ups, (d) Precision cutting of various materials in complex shapes using newly established CNC water-jet cutting machine, (e) Studies on metallic coatings using magnetron sputter-coating system, (f) Establishment of phased-array module for ultrasonic-flaw detection of materials & joints, (g) Developing tungsten coating technology for first-wall application, (h) Developing fabrication technologies for divertor & dome targets, (i) Studies on welding of thick section dissimilar steels for divertor cassette body fabrication technology, (j) Developing new tungsten based materials using powder metallurgy, (k) Small specimen testing technique development for mechanical properties of tungsten materials at elevated temperatures and (l) Engineering (Thermal, Structural, Thermal-Hydraulic, Fluid Flow, Electromagnetic) Finite Element Analysis of ITER-like divertor.

Tungsten Coating Technology Development for First-wall Application:

Test mock-ups made of CuCrZr Copper Alloy and SS316 Stainless Steel materials having cooling channel are fabricated and subsequently coated with nearly 500micron Pure Tungsten material over 50 X 30mm surface area. Tungsten coating is performed by collaborator - ARCI (Hyderabad). Integrity and uniformity of coatings is checked using Ultrasonic Testing Technique. These tungsten coated test mock-ups are subsequently tested for their thermal cyclic fatigue performance at 500°C surface temperature for 1000 thermal cycles. High Heat Flux Test Facility was used for these tests. Both the test mock-ups could successfully withstand thermal fatigue tests at 500 °C. Additional test mock-ups using Copper Alloy, Stainless Steel and IN-RAFMS steel are being fabricated by the collaborator. Special test mock-ups for studies on Hydrogen Permeation through tungsten coatings will also be fabricated.

Data Acquisition and Control System for HHF Test Facility:

Integration of DACS with various sub-systems, utilities and diagnostics/sensors of High Heat Flux Test Facility (HHFTF) is completed. Complete operation of HHFTF is performed using newly developed DACS by a private vendor. Major components of DACS system are: Main control & interface; PLC based sequential operation with Safety Interlock; PXI base Real time control loop, fast Acquisition and On line monitoring; Fast Interlocks and Slow interlocks; Human Machine Interface; PXI based console for the operator; Data Server for Storage, Analysis & Archival, Network assisted Storage (NAS) system has been procured and is being interfaced with HHFTF for storage of experimental data

for analysis and post processing. HHFTF is routinely being operated for high heat flux testing purposes.

Diagnostic & Calibration System: A high temperature Cavity Blackbody and Dry bath Calibrator is being periodically used for calibration of non-contact/contact type infra-red thermal sensing equipment such as IR-Pyrometer and IR-Camera and TC. The facility allows calibration in the temperature range of 150 – 1200 °C (RTD, TC) and 600 to 3,000 °C (IR Camera and Pyrometer).

Material Sputter-Coating System: Commissioning of Magnetron Sputter-Coating system manufactured by an industrial

The High Heat Flux Test Facility (HHFTF) is state-of-the-art facility for material plasma interaction studies which is available in very few places around the world. This helps to decide the armour materials for fusion machines which needs to withstand the extreme conditions prevailing in the edge of the tokamak

partner has been completed. The system is capable of performing coatings on substrates heated to temperature up to 1000°C.

High Heat Flux Testing: Tungsten alloy mono-block test mock-ups fabricated using diffusion bonding technique are studied for their heat removal performance under non-uniform heat load conditions relevant to ITER-like divertor. Tungsten mono-block test mock-up manufactured at IPR using vacuum brazing technology is tested for uniform extracted heat flux up to 6 MW/m². Further testing will be done at higher heat flux values. Test mock-ups with ~ 500micron tungsten coatings on copper alloy & stainless steel substrates has been successfully tested for 1000 thermal cycles at 500°C. Experimental studies to observe Critical Heat Flux are carried out on water-cooled copper alloy test mock-up with swirl-tape insert.

Tungsten Materials Development: GLEEBLE 3800 system is used for development of Pure Tungsten material in the form of a circular disk by Direct Sintering of pure tungsten powder. Tungsten powder of 1-6 Micron particle size

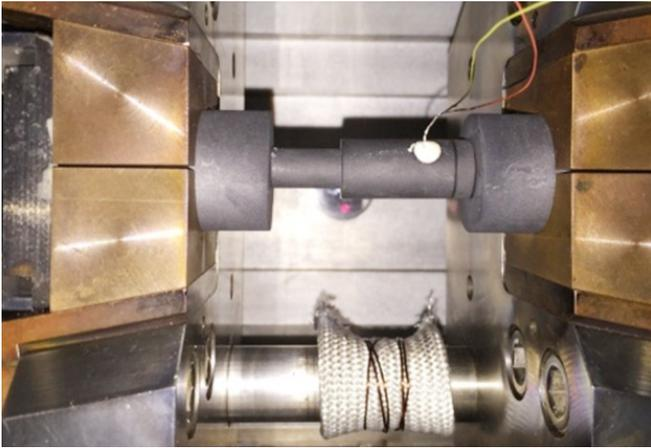

Figure A.2.4 Arrangement in Gleeble 3800 System test Chamber for sintering of tungsten powders
 is sintered at various temperatures in the range 1600-1900 °C under pressure in the range 20-60 MPa. Development of Metal-Matrix-Composite and Functionally Graded Materials with Tungsten and Copper will be attempted in future.

Small Specimen Testing Technique Development: Small specimen of tungsten materials are fabricated using precision cutting techniques such as Water-Jet cutting and EDM Wire-Cut. Suitable fixtures are developed to test these specimen at elevated temperature in Gleeble System. Specimen are tested for their tensile properties at elevated temperatures. Obtained stress-strain curves are found to be in good agreement with the data reported recently in international journal.

Brazing Studies and Brazing Experiments: Brazing, casting annealing experiments are performed for studies on fabrication of small-scale mock-ups CVD windows etc. Brazing experiments have been performed for the LHCD system at IPR and CEERI, Pilani (brazing for Ceramic to Titanium),

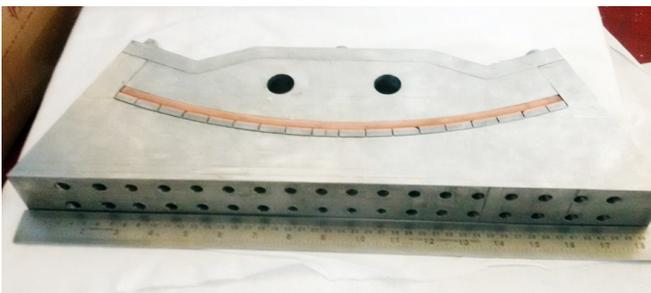

Figure A.2.6 Assembly of fixtures, tungsten tiles and copper backplate to fabricate Curved Dome Structure using vacuum brazing technique.



Figure A.2.5 Copper casting on Pure Tungsten Tiles done using Vacuum Brazing Furnace
 Cu to Cu brazing for FCIPT, Brazing of SS tube to Cu block of Limiter of SST-1 and ongoing brazing and casting activities of DFD group where tungsten and graphite are being brazed to CuCrZr.

Helium Cooled Divertor Studies: Computational Fluid Dynamics (CFD) studies are continued further on extended surface design for improvement of the design to increase heat transfer efficiency. A new concept with several holes is developed and studied for its heat transfer efficiency.

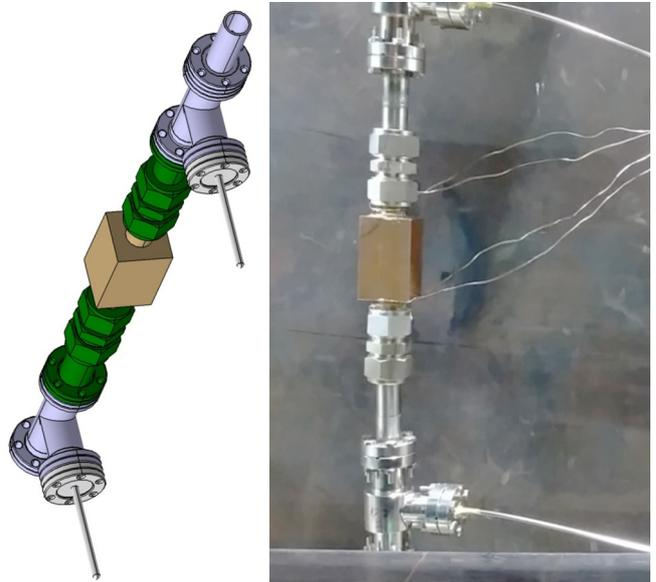

Figure A.2.7 Experimental set-up for calorimetry studies in HHF test facility using full copper test mock-up, thermocouples and RTDs

Engineering Analysis of ITER-like Divertor: Engineering analysis of the ITER-like divertor are continued including: (a) Computational Fluid Dynamic Analysis to estimate the coolant pressure drop and heat transfer coefficients; (b) Electromagnetic analysis to estimate the eddy current and structural loads induced during off normal events; (c) Thermal-Structural coupled analysis to compute stresses on various parts of Divertor as a result of various thermal and structural loads.

Electromagnetic Analysis: Electromagnetic analysis of ITER divertor under Major Disruption conditions is continued for estimating the Lorentz forces.

Ultrasonic Testing & Simulation: Efforts are being made to inspect tungsten-copper and copper-copper joint in mono-block type divertor target having curved copper alloy tube with typical radius of curvature $\sim 500\text{mm}$ and length 500-1000mm. Thick weld joints are tested using newly procured Linear Phased Array module of Ultrasonic Flaw Detector system.

CFD Simulation of HHF testing of target test mock-up: CFD computations are performed to simulate HHF testing experiments on tungsten mono-blocks, tungsten coated copper & SS test mock-ups and full copper-alloy test mock-up with & without swirl-tape insert. Simulations were carried out for various water flow parameters.

Collaboration with VSSC for software development: FEAST software developed by VSSC for finite element analysis of structures was demonstrated to IPR scientists & engineers. Discussion between IPR and VSSC representatives is held for further development of FEAST software through collaborative efforts to include Electro-Magnetic Analysis Module of interest to IPR for tokamak related analysis.

A.2.3 Pellet Injector System

Solidified form of hydrogen gas or its isotopes is an efficient method of supplying fuel particles into a magnetically confined high temperature plasma device. This technique is technologically simple and economically cheaper than other fuelling methods. In this regard, a single pellet hydrogen pellet

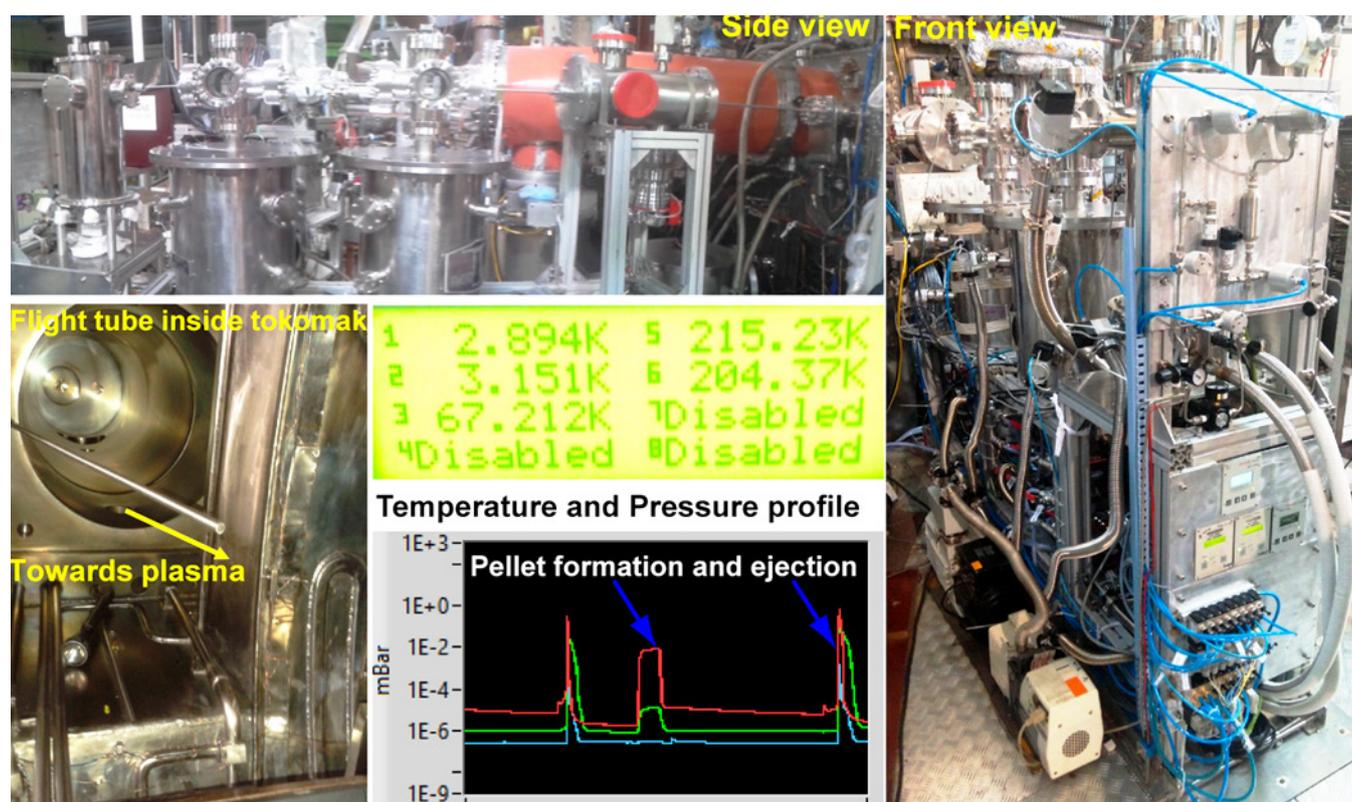

Figure A.2.8. Pellet injector system integrated to SST-1

injector is developed and successfully integrated to the SST-1 machine for pellet-plasma interaction studies in a tokamak plasma. After successful demonstration of a prototype pellet injector in laboratory, a single barrel pellet injector is designed, fabricated and integrated to SST-1 tokamak. This injector is an in-situ pipe gun type injector. In this kind of injector a pellet freezes in-situ in the gun barrel and is injected into the plasma by applying high pressure propellant gas, such as helium. The injector consists of four subsections, namely: (1) Cryo chamber (2) Gas feed system (3) Differential pumping system and (4) Data acquisition and Control system. The cryo chamber consists of a stainless steel barrel of specific dimension relating to pellet size for pellet formation. It takes approximately 40 seconds to freeze a 2 mm size ice pellet. This assures the capability of the injector to be operated in every three minutes (adding vacuum pumping times). The gas feed system supplies hydrogen gas to the freezing zone for pellet formation, and high pressure (up to 50 bar) helium propellant gas for pellet ejection and acceleration. Pellet speed is varied by regulating the propellant gas pressure. A three-stage differential pumping section is employed to restrict the flow of helium gas into the tokamak plasma. Pellet formation and ejection process is remotely controlled by using a stand-alone PLC system and input/output electronic circuits. This PLC is also used to store various data from the injector in a remote computer. Two sets of light gate diagnostic and a high speed camera ($> 200,000$ frames per second, with micro second exposure time) are installed to measure the ejected pellet speed and its size, respectively. At present, this injector is successfully integrated to the SST-1 tokamak. Using this injector, a pellet will be injected in the plasma mid-plane from an outboard location of tokamak at an angle 18° to plasma radial direction. The injector vacuum system is successfully operated at a level of 10^{-6} mbar or lower order. Similarly, pellet formation region has reached a temperature of 2.9 K, which is sufficient for pellet formation. Initial experimental results indicate that freezing of hydrogen gas is successfully attained by the injector. The system is ready for further experiment.

A.2.4 Test Blanket Module (TBM)

Indian Lead Lithium Ceramic Breeder (LLCB) blanket concept will be tested in ITER through Test Blanket Module (TBM) program. The objective of the ITER TBM Program is to generate experimental data on the performance of tritium breeding blankets in integrated fusion nuclear environment. This programme is engaged in the Design and Development of LLCB TBM and its associated ancillary systems.

Test Blanket System (TBS) and Blanket Neutronics Activities: Neutronic analyses is very important step and it provides essential inputs for the engineering design of LLCB TBM set and its associated ancillary systems. Neutronic models with updated TBM frame and TBM Set geometry has been constructed and neutronic performance of LLCB TBS in ITER has been evaluated using radiation transport code MCNP6 & nuclear cross section data library FENDL 2.1. Various nuclear responses such neutron spectrum & flux, tritium production rate, nuclear heating, gas production and displacement per atom have been calculated. Neutron induced activation calculations are needed to assess the radioactive hazards from irradiated materials and radioactive waste. Activation analyses provide the contact dose rate, decay heat and radioactivity estimations required for maintenance plan, assembling-dismantling plan and rad-waste management. The activation analysis has been performed by making use of inventory code FISPACT-2007.

Engineering Design Activities: The TBM set is subjected to extreme environment conditions, like high structural temperature (up to 500°C), high magnetic field and radiation. The TBM structure is designed to withstand various loads and its combinations, like thermal, mechanical including the high pressure coolant loads, electromagnetic loads during plasma disruption and seismic loading conditions. Detailed thermal-hydraulic and thermo-mechanical analysis has been per-

The ITER is a unique opportunity to test the tritium breeding blanket module concepts that would lead in a future DEMO fusion reactor to tritium self-sufficiency, the extraction of high grade heat and electricity production. India has planned to test the Lead-Lithium cooled Ceramic Breeder (LLCB) through its Test Blanket Module (TBM).

formed to demonstrate the structural integrity corresponding to different operating conditions (for load combinations of thermal, mechanical, electromagnetic and seismic) based on the load specifications. Appropriate classification of systems, structures and components and relevant codes and standards (RCC-MRx) has been followed for the design analysis.

Liquid Metal Process and MHD Activities: Lead Lithium



Figure A.2.9. Pb - Li Purification Loop set up with Cold Trap

Cooling System (LLCS) is one of the major systems of LLCB TBS. The operation of LLCS relies on accurate measurement of system process parameters at high temperature and its efficient control. R&D activities in Pb-Li technology development were primarily focused to develop and test of critical liquid metal loop components as well as high temperature Pb-Li diagnostics and their testing in experimental liquid metal loops. Diagnostics, which do not come in contact with hot and corrosive Pb-Li are also being explored. In this context, testing of radar level sensor and ultrasonic flow-meter in long run Pb-Li experimental loop is under progress. Cold Trap for Lead Lithium purification has been designed and developed at IPR. The experimental set up assembly for the cold trap along with the testing loop has been successfully completed.

Structural Material Development Activities: Materials development activities are under progress to develop and qualify the structural material for its use in LLCB TBM. India specific reduced activation ferritic martensitic steel (IN-RAFMS), has been developed in collaboration with IGCAR, Kalpakkam and M/S MIDHANI. For the ITER qualification, large heats of IN-RAFMS have been produced to generate the physical and mechanical properties database as per the RCC-MRx guidelines. The experimental database of physical and mechanical properties is being generated at IGCAR and IPR along with other collaborative institutes within India. The results are comparable with lab scale heats and also comparable with internationally developed RAFMS. These properties are used for the conceptual design of LLCB TBM.

Corrosion studies of Indian Reduced Activation Ferritic-

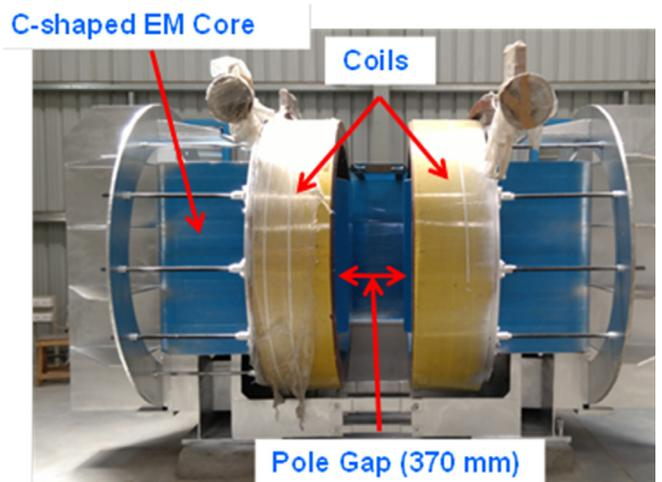

Figure A.2.10. Electromagnet assembly for Pb - Li MHD experiment

Martensitic Steel (RAFMS) with Lead Lithium Eutectic: Compatibility of the TBM structural material with the liquid Lead Lithium is one of the prime concerns for the successful operation of LLCB TBM in ITER. Corrosion experiments are being performed in “thermal convection loop” and “pump driven loop”. Flat and tensile IN-RAFMS sample coupons are loaded in both the loops and are being exposed to flowing

Many small experiments have been set up to study and optimize the various processes which would be utilized in designing the TBM.

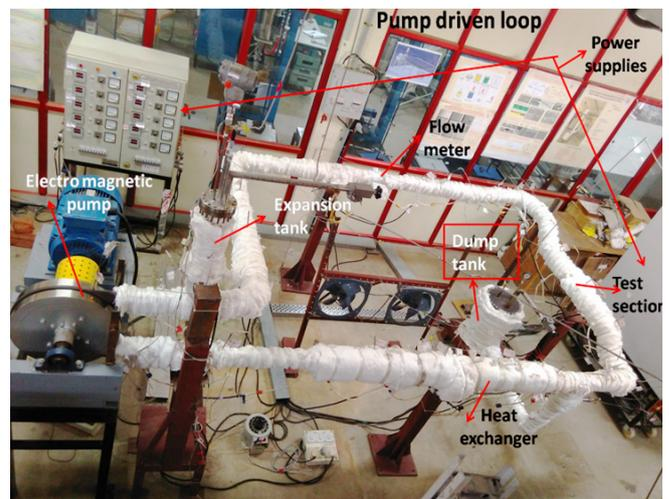

Figure A.2.11. Pump Driven loop for corrosion studies

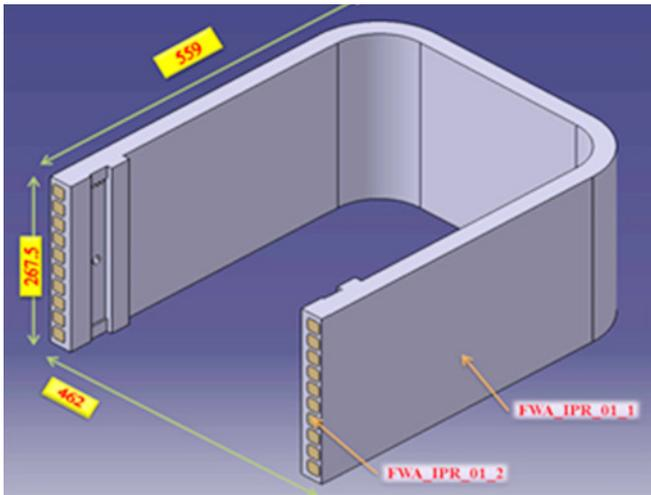

Figure A.2.12. Isometric view of 10 channels U shaped First Wall Mock-up

Pb-Li. The samples will be taken out of the loop after regular intervals of time(for ex : 1000, 2500 and 5000 hours) and then the properties are studied along with the corrosion rate.

Fabrication Technologies Development Activities: Mock-up

fabrication activities are under progress to identify feasible manufacturing route, fabrication processes and assembly sequence to be adopted for the fabrication of full size LLCB TBM set. The fabrication and inspection procedures adopted are as per codal requirements specified in RCC-MRx and guidelines provided in the ITER vacuum hand book. This exercise will provide inputs for finalization of LLCB TBM design. Development of several small scale mock-up of TBM components are envisaged. A small scale of TBM First wall is being fabricated by Hot Isostatic Pressing (HIP) and by conventional fabrication techniques. An eight channel mock-up of FW using IN-RAFM steel and dense ceramic core insert is under fabrication. As a conventional machining technique fabrication of TBM FW 10 channel mock up using gun drilling, wire EDM Cutting & machining followed by Hot Bending is also under progress (see Figure A.2.12).

Ceramic Pebble Development Activities: Qualified Li_2TiO_3 pebbles have been developed as the tritium breeder for LLCB TBM. The production facility is currently under up gradation from 40 kg/year to 80 kg/year to meet the requirements. The necessary characterization facilities have also been installed. At every stage (powder, pellet and pebble preparation) of

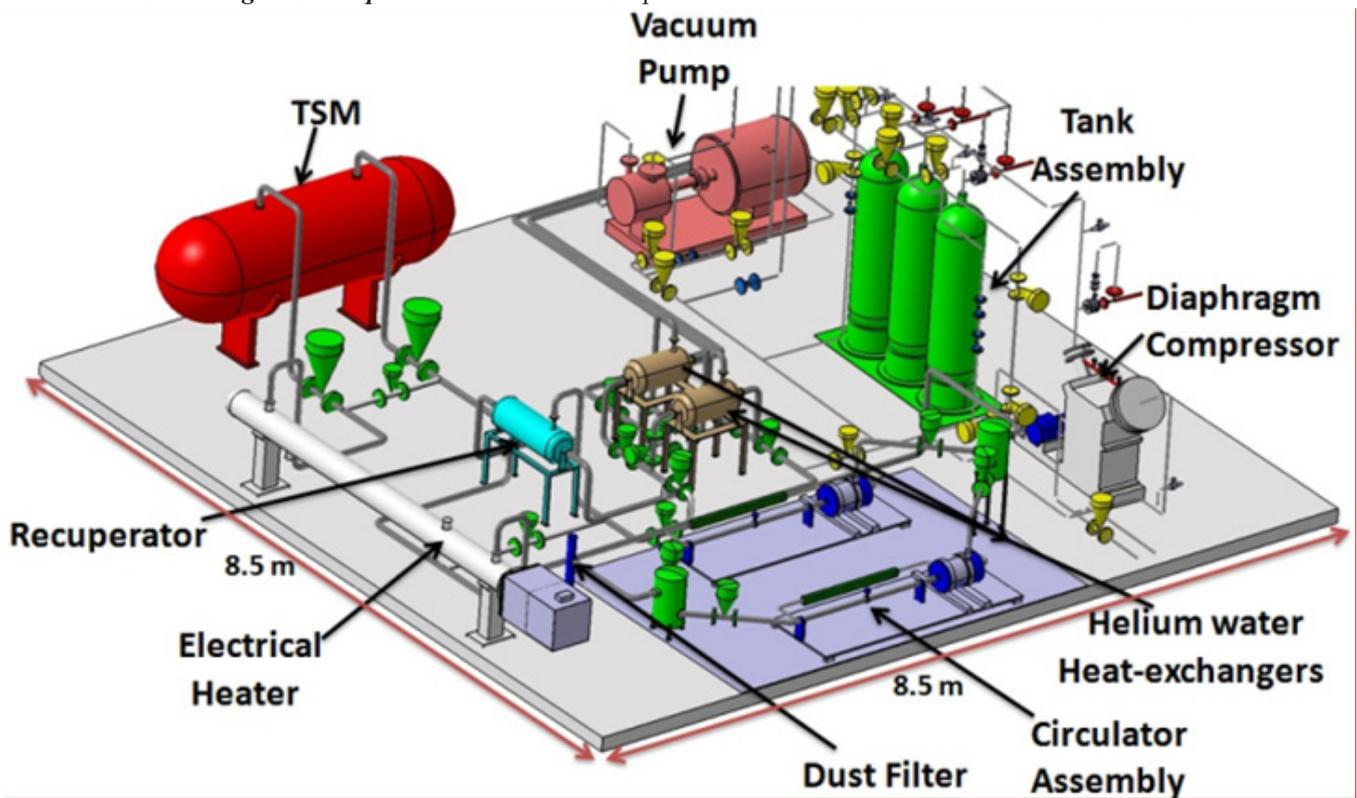

Figure A.2.13 3D model of Experimental Helium Cooling Loop

preparation, powder and pebbles, extensive characterizations are also being carried out to make extensive data base for material qualification. The high temperature effective thermal conductivity measurement of pebble bed with steady state axial heat transfer method & hot wire method has been started and under currently under progress. These experimental setups have been indigenously developed.

Helium Cooling Systems Development Activities: An Experimental Helium Cooling Loop (EHCL) facility (450 °C, 0.4 kg/s) is being set up (see figure A.2.13) to perform R & D experiments and to experience the operation and control requirements for FWHCS and LLHCS. The conceptual design of the EHCL was carried out in-house and the procurement of loop equipment such as circulators, heat exchangers, electrical heater, valves, and instrumentations are under progress.

Instrumentation & Control Design and Development Activities: R&D efforts to develop process instrumentation for liquid metal applications are under progress.. An experimental study was carried out towards precise validation of pressure sensors specific to LLCS operating conditions in TBM. Indigenous test facility (see figure-A.2.14) was designed and fabricated for performance validation of pressure sensors for high-temperature, high-pressure corrosive liquid Pb-Li. Calibration of these sensors at temperature between 380-400 °C and at pressure upto 10 bar (g) was performed. Reliability and performance validation was ascertained by continuous long duration testing for over 1000 hours. Instrumentation & Control system architectures were designed for Plant Control System (PCS), Plant Interlock System (PIS) and Plant Safety System (PSS) of LLCB TBS. Functional Breakdown Struc-

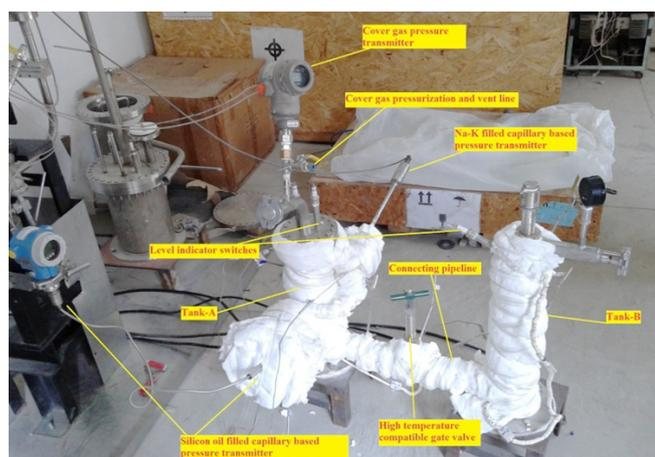

Figure A.2.14 Pressure sensor calibration test facility for Pb-Li application

ture (FBS), Failure Modes, detailed Process & Instrumentation Diagrams (P&IDs) and Safety Functions were prepared for ancillary systems of LLCB TBS.

TBM Safety and Neutron Diagnostics Development Activities: LLCB TBS safety analyses in ITER are required for obtaining the regulatory approvals. Safety analysis of LLCB TBS was carried out using RELAP/MOD4.0 code and various accident scenarios were analysed. For the validation of the safety analyses of LLCB TBS, an experiment is designed and performed to study the PbLi-water interactions and also to measure hydrogen produced. In order to enhance the capabilities of RELAP/MOD4.0 code it is modified to handle accident scenarios involving PbLi/Helium mixtures and several calculations have been performed to validate the modified code. Benchmarking exercise relevant to actual TBM accident scenarios using the modified code is on-going. Neutron diagnostics are being developed for LLCB TBM for the measurement of neutron spectra & fluxes and tritium production rates in TBM which will validate the nuclear design of LLCB TBM in ITER. Diamond detector, Neutron activation system (NAS) and Micro fission chamber (MFC) are proposed as neutron diagnostics for TBM applications. Diamond detector and MFC detectors are being developed with BARC and first set is in final stage of testing with IPR neutron generator. Conceptual design of Neutron Activation System has been proposed by IPR and components design is in R&D phase under collaboration with BARC, Mumbai.

A.2.5 Large Cryogenic Plants & Cryo-systems

This programme is mainly involved for the indigenous helium refrigerator/liquefier (HRL) plant development of cooling capacity 1 kW at 4.5 K. As this is a complex plant project, it is planned to achieve in 2 phases: Phase-A, in which HRL will be made as semi-indigenous with some of the key components like helium compressor and oil removal system (CORS) will be imported and other key components will be made indigenously. Phase-B will involve full indigenization.

Detailed design of prototype components: Main components of plant which will be indigenous in phase-A are: 3 different (2-stream-He/He and He/boiling LN₂ and 3-stream-He/He/He) kind of cryogenic plate-fin heat exchangers operating between 300 to 15 K with helium flow rate 30 g/s for cold stream, 2 different helium purifiers operating at temperature 80 K and 20 K with flow rate 50 g/s. These heat exchangers are counter-flow type. These are manufactured by brazing in a vacuum furnace at a temperature of 600°C. These are made

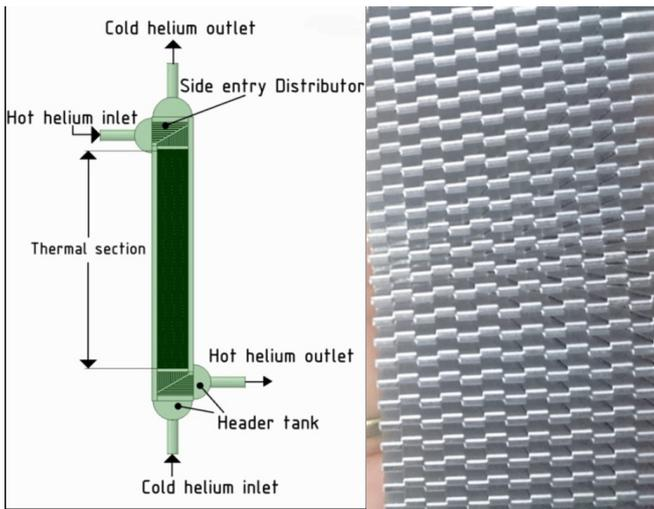

Figure A.2.15 (a) A two stream heat exchanger

(b) A part of serrated fin layer being manufactured

of aluminium alloy which are good for machining and has good mechanical properties at low temperature. The detailed design of these prototypes, review, tender document preparation for manufacturing are finished. Figure A.2.15 (a) shows a 2-stream heat exchanger designed and figure A.2.15(b) shows a part of serrated fin layer being manufactured for prototype LN₂ precooling heat exchanger. These should have high thermal effectiveness and for some heat exchangers this should be more than 97%. After design of these prototype heat exchangers, results are compared with existing helium plant heat exchanger parameters as a 1st step. In the 2nd step,

Aspen software results were compared and in the 3rd step CFD (computational fluid dynamics) analysis was carried out. A part of the CFD analysis work for plate-fin heat exchanger shows the velocity variation alternately in free space within fins. The CFD analysis shows that the pressure drops in real system will be up to 20% more than calculated from the correlation-based formula. For heat transfer coefficient estimation, CFD analysis is in progress. Finally this manufactured heat exchanger will be tested at low temperature.

Detailed design of full-scale components: The detailed design methodology for prototype components and full-scale components are nearly similar. Based on these procedures, computer codes have been developed which will be helpful for detailed design of full-scale components also. For the full-scale components, many interface aspects with other components and off-nominal operational situations need to be worked out.

Detailed design of test facility: Detailed design of heat ex-

The future fusion based power stations are expected to have very large superconducting magnets which would require very large cryogenic plants. This activity plans to build large cryogenic systems through small modular cryogenic plants

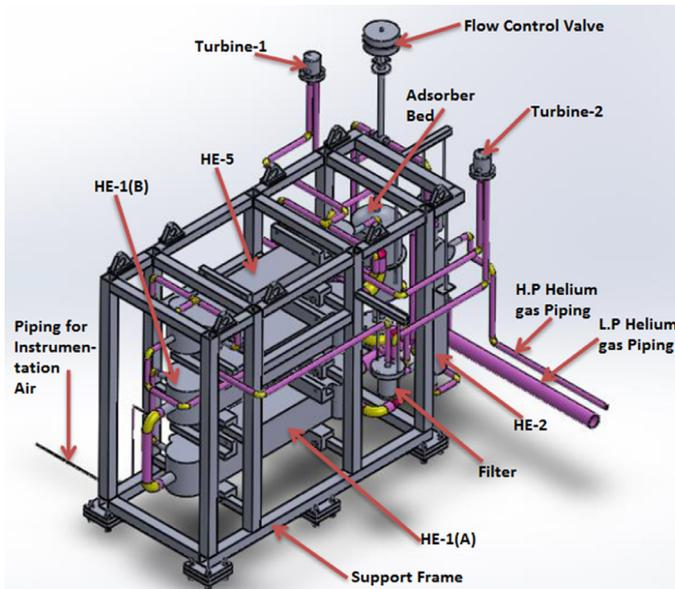

Figure A.2.16 Assembly for turbine test

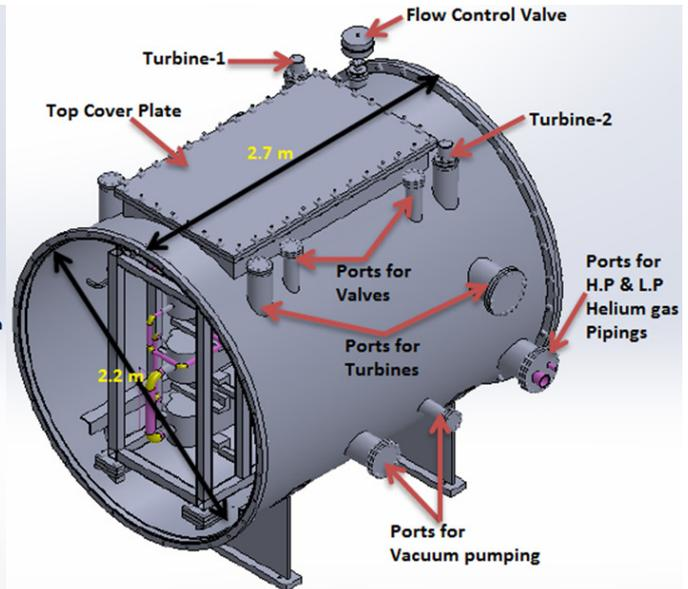

Figure A.2.17 Vacuum Chamber for turbine-Test Facility

changer test bed and turbine test bed are in progress and expected to be finished soon. Turbine test facility can accommodate turbines of both vertical and horizontal configurations. It can also accommodate both aerostatic and aerodynamic type contact-less gas bearings. The helium cryogenic turbines which will be tested in this test facility will have rotational speed in the range of 1.5 to 3 lakhs RPM and for such high speed contact-less gas bearings are used. Figure 3 shows the vacuum chamber with internal components of turbine test facility. Detailed design of heat exchanger test facility is also expected to be finished soon. There are 9 blocks of full-scale heat exchangers and 4 blocks of prototype heat exchangers, all of which will be tested in this test facility.

Instrumentations and controls development: Dynamic analysis of the helium compressor and oil removal system operation has been tried using Aspen software. The control logic for the automatic operation sequence of compressor system are worked out conceptually. These will be further worked out after which it will be used in the helium plant control system. A PLC and versatile display unit for cryogenic sensors are being developed.

Activities towards fully indigenous plant: For development of helium CORS, an air compressor is being procured for conversion to helium compressor and further this will be helpful for automated helium compressor development which is required for helium HRL plant. Cryogenic helium turbines of required process parameters are being designed at

NIT, Rourkela by a dedicated team.

A.2.6 Remote Handling & Robotics Technology

Remote handling (RH) is often described as the synergistic combination of technology and engineering management systems to enable operators to safely, reliably and repeatedly perform manipulation of items without being in personal contact with those items. The scope of the project is to build a versatile Remote Handling System for Indian fusion devices. The development of the technologies and systems will be in a parallel and interrelated mode with support of external agencies and institutions. In the report period the main focus was on the virtual reality development, viewing applications, a higher payload (20Kg) articulated arm and RH control system applications development.

Development of Virtual and Augmented Reality Integrated Development lab (VARID-lab): A low cost solution for Virtual Reality facility has been conceptualized and realized at the remote handling and robotics division. This facility – VARID-Lab will be utilized to develop various virtual and augmented reality applications that will have the flexibility to integrate with remote handling equipment and scale the developed applications to the planned major VR facility. The functional specifications of the VARID-Lab aim at research and development in 4 major areas of virtual and augmented reality: (i) Computer Vision & Tracking, (ii) Visualization,

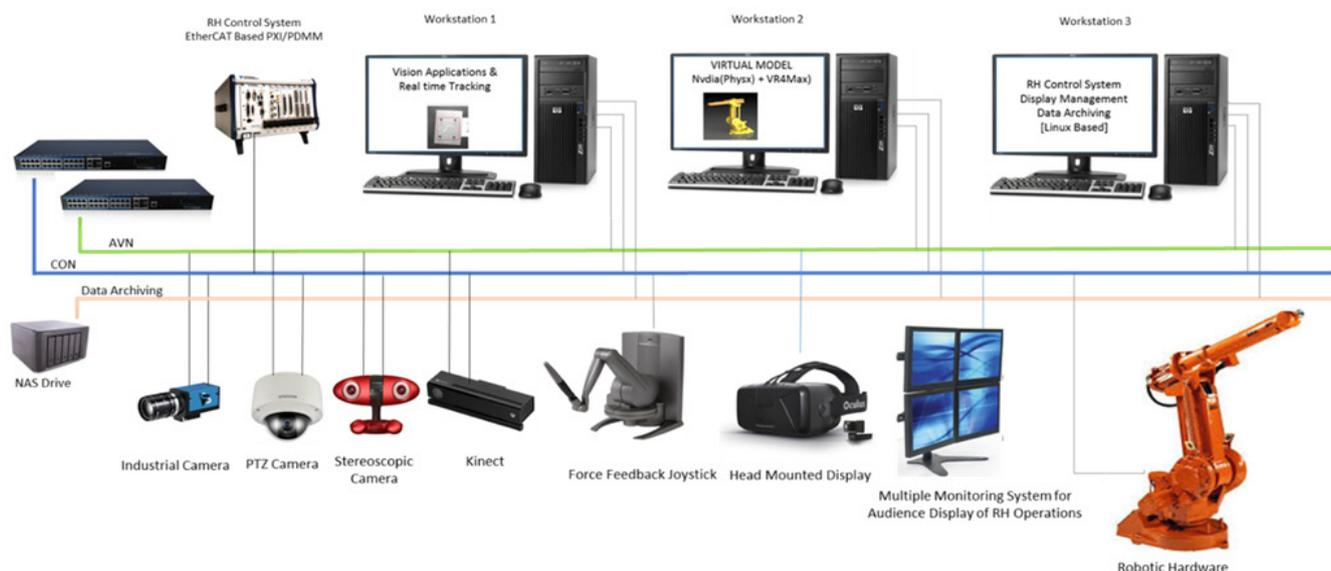

Figure A.2.18. Functional Diagram of Virtual and Augmented Reality Integrated Development (VARID) Lab



Figure A.2.19 Stereoscopic Camera Setup

(iii) Real Time Hardware Integration to Virtual and Augmented Reality and (iv) Kinematic Physics Studies. To meet the above mentioned functional specifications, the required hardware and software have been procured and integrated into a complete setup. All projects related to image processing, augmented reality, virtual reality, control system devel-

opment, remote monitoring and control of robotic systems and integration of virtual control to robotic systems are being integrated to the VARID-Lab platform to create a centralized facility.

Development of Real Time Stereoscopic Immersive Viewing: For carrying out crucial remote handling operations inside a tokamak, the operator is required to have an immersive view of the environment and the operation to be performed. Under this development a stereo-rectified camera pair module has

Remote Handling and Robotics technology would be a vital technology for the maintenance of plasma facing components and other sub-systems of a fusion machine. Here it is being developed through international collaborations.

been integrated to a pan-tilt-roll mechanism and the video streams from the cameras are fed to an active stereoscopic head mounted device.

Conceptual Design Of Prototype Robotic Articulated System (Pras 02): With the successful design and development of the PRAS-1, development of PRAS-2 has been started. This system is a 5 DOF equipment exhibiting snake like articulation for traversing a toroidal workspace. The system is designed

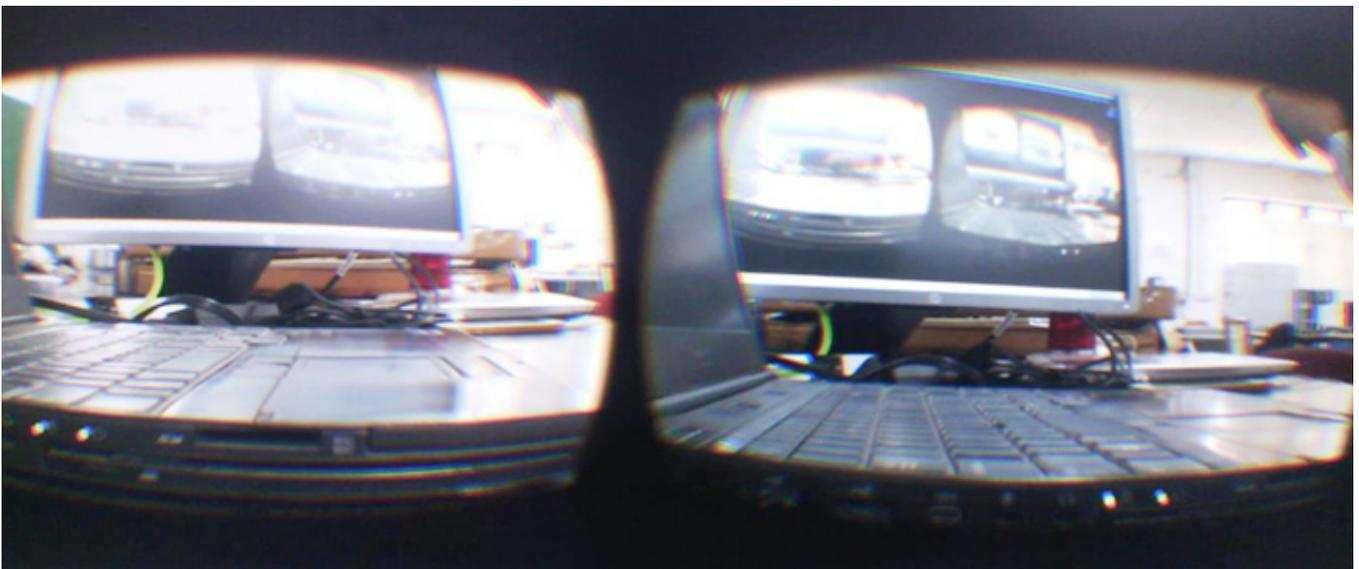

Figure A.2.19a View of Stereoscopic Camera Setup as seen by the Operator using a Head Mounted Display



Figure A.2.20 A Virtual Model of the Robotic Platform that is augmented on top of the camera view and controlled based on the orientation of the platform visually

to carry a maximum payload of 20kg at 2m. The system will be integrated to haptic controlled virtual reality setup for on-line control, tracking and monitoring of operations.

International Collaborations: This programme is having running collaborations and task agreements with ITER on

validation of the ITER RH Control system, Concept design and system analysis of the Multi-Purpose Deployer, Remote handling compatibility assessment of the ITER MPD. The following are some of the major contributions of the RHRTD team towards the ITER RH activities.

Concept design and system analysis of ITER Multi-Purpose Deployer (MPD): The Heavy Duty Multi-Purpose Deployer (HD-MPD) with designed payload capacity up to 5.8 tons is an articulated remote handling equipment for the handling of Shield blocks (including the heaviest blocks in NBI region) and rescue of the failed Light Duty (LD) MPD in the Vacuum Vessel. The HD MPD operation requires opening of the two equatorial ports. A concept design of the HD MPD has been performed to provide heavy load handling capability inside the Vacuum Vessel targeting to the blanket shield block handling. The internal spaces within the HD MPD bodies were secured as much as possible for housing the actuator components. The existing design constraints were respected such as port dimensions, cask envelope, etc. The Joint load analysis has also been carried out to assess the required performance of the joint actuators. Suitable reinforcements were implemented to satisfy the required structural integrity. The detailed deployment sequence of the HD MPD has been dem-

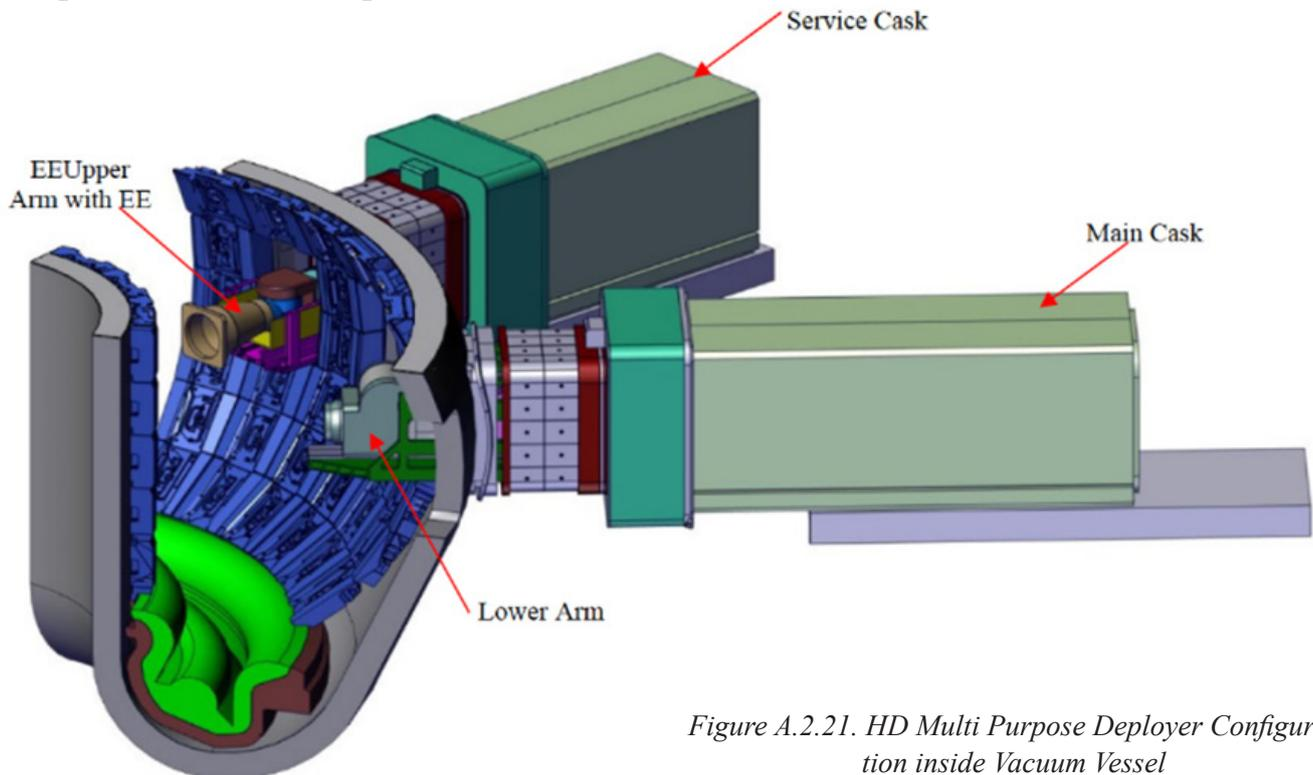

Figure A.2.21. HD Multi Purpose Deployer Configuration inside Vacuum Vessel

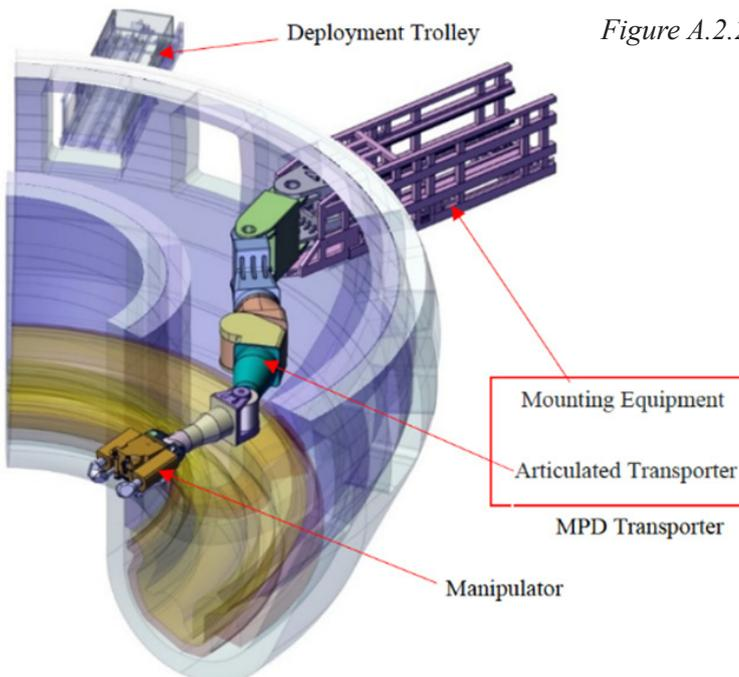

Figure A.2.22 HD Multi Purpose Deployer (MPD) Subsystems

has been performed for 1 hour on the 550kW resistive dummy load by floating EPSS (-35 kV, 15 A) over APSS (-11 kV, 35 A) with EPSS at full load and APSS at 10% load, and vice-versa. After these tests, the power supplies are integrated and commissioned with negative ion source ROBIN and successfully operated with remote DACS. A 3-phase 800A LT sub-distribution panel, in order to cater experimental loads in the HVPS facility has been successfully tested and installed in NNB HVPS facility. A new 1MHz, 100 kVA RF transformer has been designed and developed for the RF matching network of the ROBIN facility with improved performance of the magnetics and reduced overall losses. A new ferrite based 50 kHz, 20kVA; -70 kV DC isolated transformer has been designed and developed for the modules of high voltage power supplies with improved regulation and total losses. Addition High accuracy DC current sensor circuitry, floating at -46 kV, has been designed, tested and

installed in the ROBIN facility to measure the beam, electron and drain current for volume mode as well as surface mode of source operation. An electronic circuit has been conceptualized, designed, developed, bench-tested and installed in the ROBIN experimental setup to enable the detection of plasma ignition through the measurement of plasma grid bias current, as an alternate approach to the present detection through H-alpha.

(b)Up-gradation of Data Acquisition and Control System (DACs) of ROBIN: The volume mode beam operation has been done successfully through the upgraded DACs. The Cesium (Cs) Oven, Plasma Grid (PG) heating power supply, heating water system and calorimeter subsystem is integrated with DACs. Laser Photo-detachment Diagnostic (LPD) acquisition interfaced with DACs. The surface mode beam operation with ROBIN DACs has been done successfully.

(c)ROBIN and Cesium Experiments: Negative ion beam extraction experiments are performed in volume mode using EPSS and APSS with 73.38 cm² extraction area and ~ 8 mA/cm² current density achieved in volume mode in ROBIN. After that ROBIN experimental facility has up-graded for surface mode negative ion beam extraction experiments. In surface mode; Cs vapors are injected into the source which lowers the work-function of the plasma grid (plasma facing grid) and enhanced negative ion production by surface proc-

onstrated for each different configuration of the HD MPD. *Amendment to the remote handling control systems task agreement:* The objective of this work is to carry-out the detailing of the RH maintenance tasks, construct simulation task environments, demonstration of the RH tasks and performance assessment for the following tasks: (i) VR based Decontamination Assessment of the Multi-Purpose Deployer (MPD) in the Hot Cell; (ii) Blanket Manifold Handling in Vacuum Vessel; (iii) Maintenance Assessment of RH Equipment in Hot Cell

A2.7 Negative Ion Neutral Beam System

The activities of the project can be classified into four categories namely (i) ROBIN (ii) Twin Source, (iii) Indian Test Facility (INTF) and R&D experiments.

(i) ROBIN

This activity has progressed mainly in three tracks (a) Electrical Systems (b) Data Acquisition and Control System (DACs) and (c) ROBIN and Cesium Experiments

(a)Electrical Systems : Integrated testing of high voltage power supplies (Extraction Power Supply System – EPSS and Acceleration Power Supply System – APSS) power supplies

ess. Cesium (Cs) oven with all necessary equipments and instrumentation are implemented. Negative hydrogen ion beam extraction experiments in surface mode have been performed in ROBIN and source performance is being optimized.

(ii) Twin Source

Manufacturing of mechanical components of twin source have progressed well. All machining activities on stainless steel and OFC-Cu components are completed as shown in Fig. 6. Extensive efforts have been put on joining the similar & dissimilar materials like stainless steel and OFC-Cu for sub-assemblies like plasma box lateral wall, faraday shield assembly and source back plate. These components are brazed in a vacuum furnace. TWIN is expected to be delivered soon.

Detailed engineering design of TWIN source extraction and acceleration system with three grid system has been initiated for (80x4) beamlet group. Water cooling system design is completed for a dedicated thermal management of TWIN source experiments. Detailed P&I generated with piping operation, functional and safety requirements. Tender has been released for fabrication and installation activities. 1600A ACB based LT Main Distribution Panel (MDP) is installed at site along-with its Sub Distribution Panels (SDPs) of 200A for electrical system, 200A for DACS and 200A for vacuum system. 800A RFG junction box has been mounted on the wall which feeds the 3-phase 415V AC 50Hz experimental power to RFG. 3V 6000A DC power supply has been procured which will be used in Twin Source experiments for Plasma Grid (PG) filter field generation in the 2nd stage of experiment.

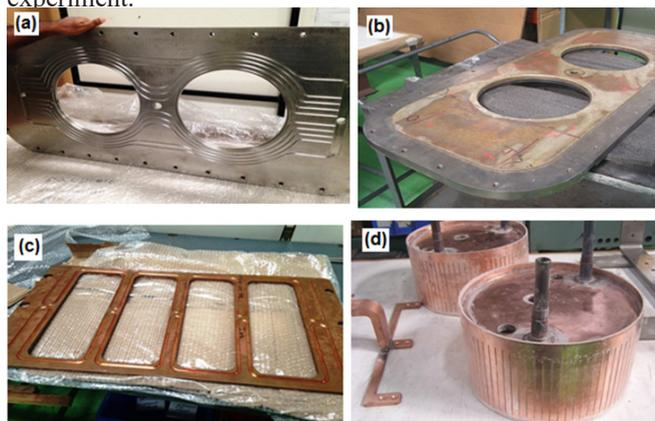

Figure A.2.23 Vacuum brazed components of TWIN source

(iii) Indian Test Facility (INTF) and R&D experiments.

(Please refer Section B.2.7, page 55)

A.2.8 Fusion Reactor Materials Development & Characterization

Oxide Dispersion Strengthened (ODS) Steel Development

Activity: As part of the fusion materials program, the development of Oxide Dispersion Strengthened steels with RAFM/RAF alloys has been initiated and MoU has been signed with ARCI (International Advanced Centre for Powder Metallurgy and New Materials), Hyderabad for the development of nano Yttria Powders and consolidation of 9 Cr RAFM & 14 CR RAF ODS alloys. For the Other part of developing the plates by Hot Isostatic Pressing (HIP) process development is in progress with DMRL, Hyderabad. The preliminary trials for the development of 6 mm & 12 mm thick plates are in progress.

Tritium Barrier Coating Activity: The on-going activity of tritium barrier coating development was further pursued for improvement in the desired properties of the coatings by both the methods, namely Metal organic decomposition method and reactive magnetron sputtering method. Systematic improvisation of Er_2O_3 coating surface morphology with variation in process of Metal organic decomposition using dip-coating technique is achieved as can be seen in the Scanning Electron Microscope images in Figure A.2.25. Reduction in the substrate roughness and changing from conventional common heat treatment to individual heat treatment cycles yielded drastic improvement in the adhesion and intactness

Though the fuel is not radioactive (both before and after burn), efforts are on to achieve zero radioactivity in all other materials to be used in the fusion power plant. This includes selection of material composition and their structure. This activity is to orient the material studies in that direction.

of the coating.

MgAl_2O_4 ceramic development activity for IR and RF windows: Magnesium Aluminate (MgAl_2O_4) is considered as high performance ceramic material due to their excellent thermal shock resistance, high resistance to chemical deg-

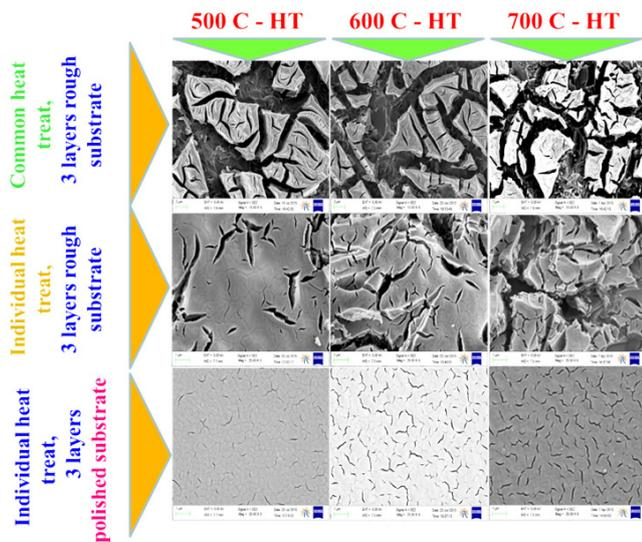

Figure A.2.24 Scanning Electron Microscope images of surface micrographs of Er_2O_3 coating deposited by Metal Organic Deposition method

radiation, good optical and dielectric properties. It also exhibits great structural stability under neutron irradiation environment, makes it suitable for application in high radiation environment such as fusion reactor. $MgAl_2O_4$ development activity has been proposed with the aim to use as diagnostics and RF windows in fusion reactors. The nano sized $MgAl_2O_4$ powders have been prepared using Sol-Gel technique by optimization of process parameters. The ceramics discs samples (25mm diameter x 4 mm thickness) will be prepared from prepared nano size powder using compaction press followed by high temperature sintering for achievement of high densification and transparency.

Fabrication technology and joint characterization Activity: The fabrication technologies R&D for the joining and characterization of the mechanical and metallurgical properties have been carried out for Austenitic steels which are widely used in fusion reactor development. Major processes like TIG welding, Electron beam welding and Laser Welding techniques have been carried and their welds joints properties characterization has been carried out. NDT (Non Destructive Test) techniques development by Ultrasonic scans examination for thick steels (~60 mm AISI SS316L plate joints) procedures are established with in-house developed calibration and low cost Ultrasonic instrument with suitable probe. Pure thick Copper coating on steels is required for in-vessel materials and is realized with the fabrication routes by Laser

cladding and Cold spray procedures.

Ion Irradiation Induced Defect Study on Tungsten under the IAEA agreement: Tungsten is the Plasma Facing Material in Fusion Reactors. With the objective to study the Structural, microstructural and Morphological changes in Tungsten after low (0.1 MeV) and High (80 MeV) energy Heavy ion irradiations and Hydrogen trapped/retained in un-irradiated and pre-irradiated Tungsten as a part of Co-ordinated Research Project (CRP) titled “Radiation damage and H/D retention studies on ion-irradiated Tungsten and its alloys - Experiments and Modeling”, under the IAEA agreement. The work has been carried out in collaboration with scientists at other organizations such as IUAC, IGCAR, BARC and ARCI in India.

A.2.9 Fusion Fuel-Cycle Development

Activities towards development of laboratory scale hydrogen isotopes removal system (HIRS) for He purge gas: Development of Atmospheric Molecular Sieve Bed (AMSB) is complete except a few minor refinements. Design of CMSB is over and the purchase procedure for same is under progress. Design of Pd-Ag membrane front end permeator has been undertaken under collaboration with ENEA laboratory, Frascati, Italy. The preliminary design and parametric analysis of Pd-Ag membrane for HIRS has been completed. The design of the membrane prompted us to investigate further to assess the suitability of the membrane for a low pressure system like TES. So experiments were planned in HYdrogen FRAscati MEMbrane (HYFRAME) permeator at ENEA, Frascati, for the operating conditions of HIRS but at a reduced flow rate. The experiments were carried out in the temperature range of 300-450 C and pressure range of 1-3 bar. It has been observed that maximum efficiency of 90% is achieved only when the membrane is operated at 3 bar and 400 C. At operating pressures of 1-2 bar, the efficiency is between 17-60%. So, the regeneration pressure at the outlet of CMSB must be maintained at 3 bar for effective hydrogen isotopes separation for He gas.

Preparation and analysis of helium purge gas mixture to be used in Tritium Extraction System of LLCB TBM: Hydrogen isotopes are extracted from the Ceramic Breeder (CB) and liquid Lead Lithium (Pb-Li) Breeder of Lead Lithium Ceramic Breeder (LLCB) Test Blanket Module (TBM) with Helium purge gas. An experimental set up is developed for making up the purge gas mixture with a composition similar to the purge gas composition. The analysis of the purge gas mixture is performed using a highly sensitive Gas Chromatograph (GC) system with ionization detector. The experimen-



Figure A.2.25. Developed experimental setup for helium purge gas preparation in operation

Figure A.2.26. 3D layout for hydrogen isotope extraction system (HIES) experimental set-up

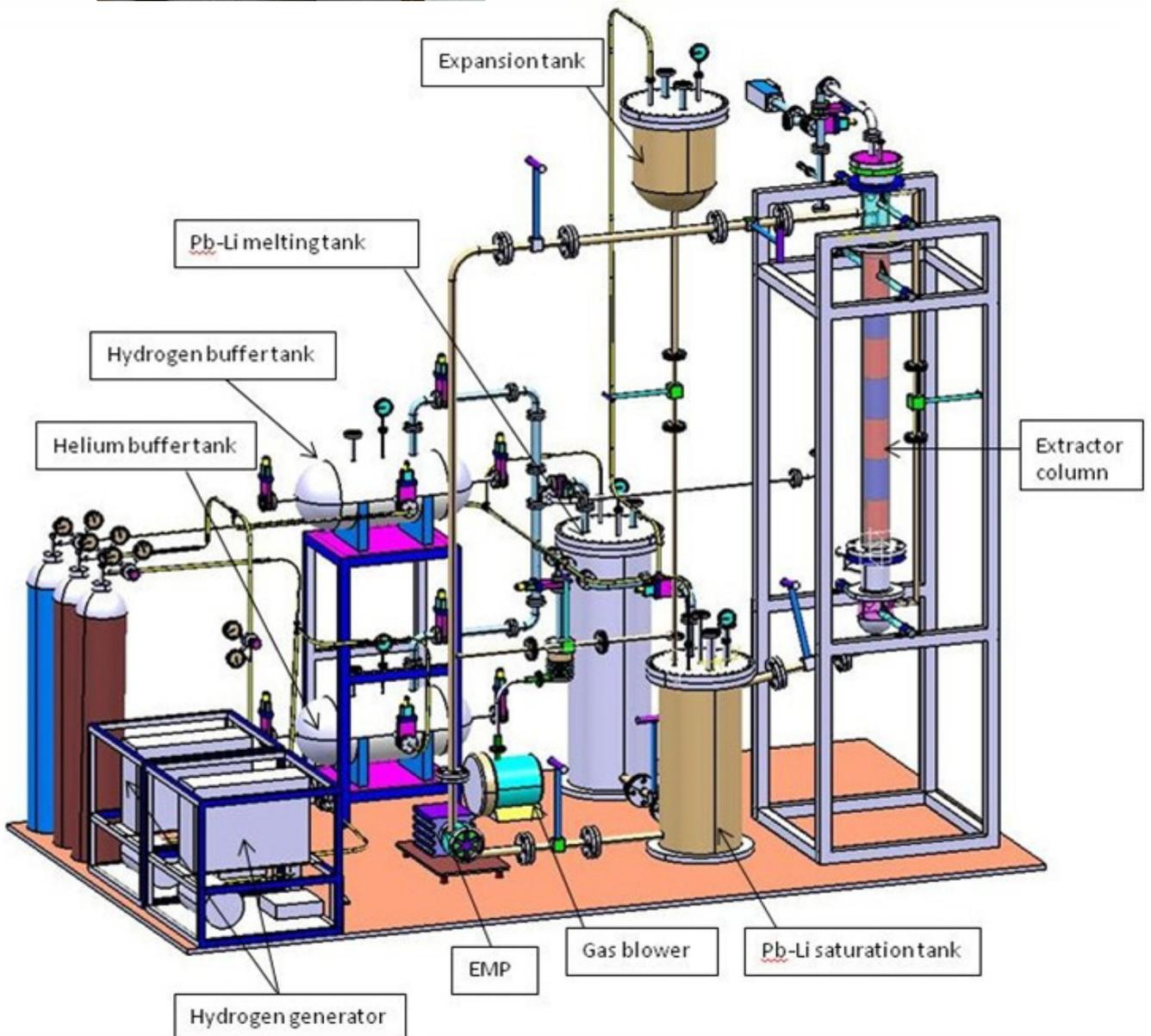

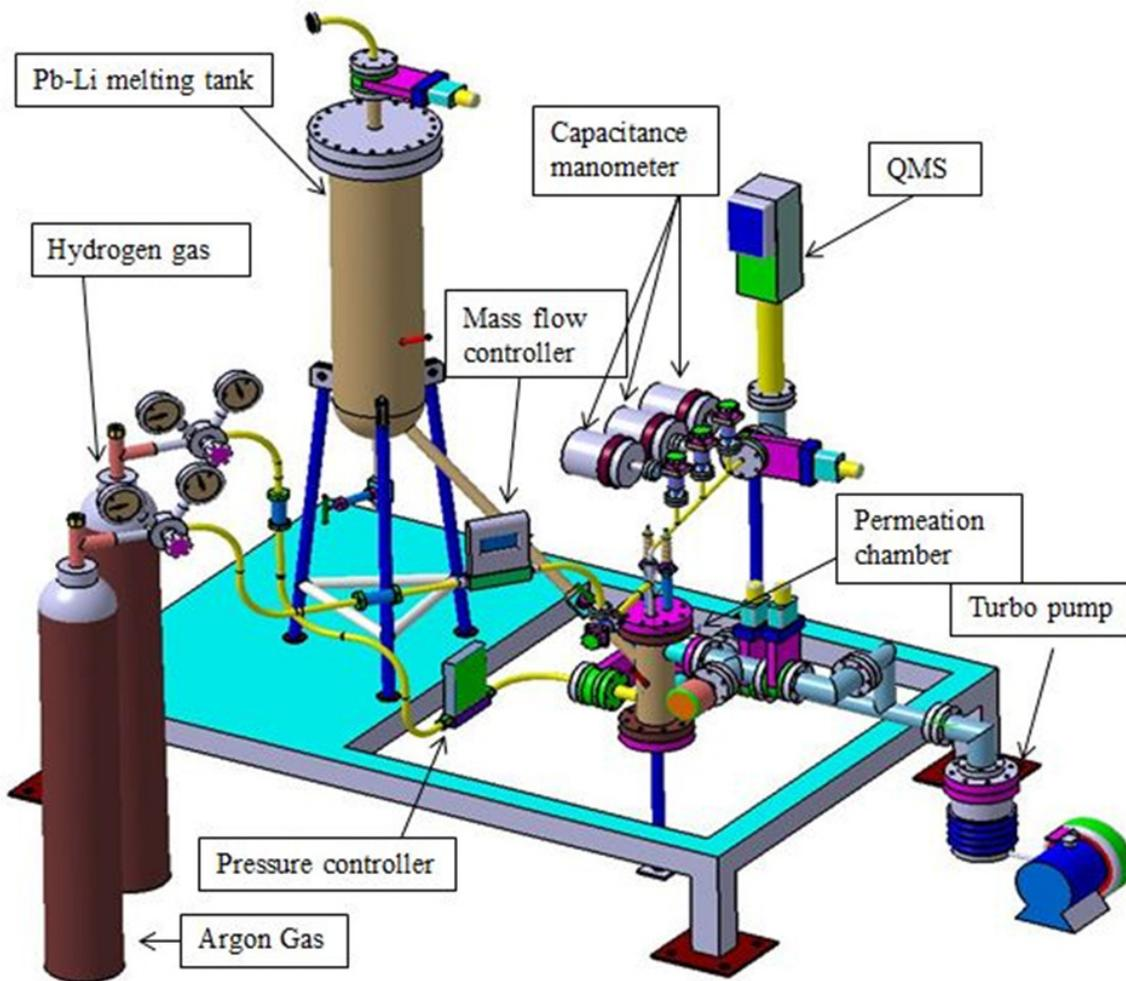

Figure A.2.27 Preliminary 3D layout of the experimental set up to determine hydrogen isotope solubility in liquid Pb-Li

tal set up developed for preparation of helium purge gas are shown in Figure A.2.26.

Activities towards development of hydrogen isotope extraction system (HIES) for liquid PbLi: An experimental set up in laboratory scale of HIES is being constructed. 3D layout of experimental set up is shown in Figure A.2.27. Fabrication drawings are complete. Fabrication of experimental set-up would be initiated soon.

Activities towards development of experimental set up for determining solubility of hydrogen isotope in liquid PbLi: Preliminary 3D layout of the experimental set up for determining hydrogen isotope solubility is shown in Figure A.2.28. Equipment to be used in the experiment (viz., vacuum pump, mass flow controllers, electronic pressure controllers, capacitance manometers, residual gas analyser, temperature sensors, temperature controller, UHV valves, vacuum gauge

etc.) have been procured. Fabrication of Pb-Li melting tank and permeation chamber is completed. Laser welding of iron foil to the permeation chamber is under process.

Activities towards development of hydrogen isotopes sensors: These are to measure hydrogen isotopes dissolved in PbLi liquid along with its process related set-up, components and equipment: Measurement of hydrogen isotopes in liquid PbLi is a challenge as it is not available in the market. It is still in R&D stage world over. Two types of sensors have been planned for this purpose. First type is based on permeation of hydrogen isotopes, whereas the second type is based on proton conducting electrochemical.

(a) *Permeation based hydrogen isotopes sensors:* These sensors have been developed. Experimental set up to test the sensors in gas phase is shown in Figure A.2.28. Experiments in gas phase will prove the concept. Experiments have been



Figure A.2.28 Testing set up for isotope sensor in gas phase

initiated. Once the sensors are tested in gas phase, they will be tested in liquid PbLi. Design of the experimental set up to test in the liquid phase is also complete. Three sensors can be simultaneously tested in this set up. . The procurement and fabrication of components are under progress.

(b)Development of solid state proton conducting ceramic for electrochemical based hydrogen isotope sensor: The hydrogen sensor using a proton conducting electrolyte can be described as a galvanic cell formed by a reference electrode, a solid electrolyte (proton conductor) and a working electrode. The electrochemical potential developed across the electrodes due to conduction of protons through the solid electrolyte (ceramic) gives concentration of hydrogen isotope dissolved in Pb-Li. Synthesis of solid state proton conducting ceramic, which acts as an electrolyte, is one of the most important and challenging task towards the development of electrochemical based hydrogen isotope sensors. The required ceramic was prepared by mixing and mechanically grinding SrCO_3 , CeO_2 and Y_2O_3 for 40 hours and calcination at $1000\text{ }^\circ\text{C}$ for 8 hours. Finally with 40 hours of ball milling and 8 hours calcination at $1100\text{ }^\circ\text{C}$, SCY phases have been observed in almost all the peaks of the XRD. Cylindrical pellets of thickness 1.5 mm, 2 mm and 3 mm and diameter of 15 mm from the prepared SCY ceramic powder have been prepared and sintered at $900\text{ }^\circ\text{C}$ for 10 hours.

--!!!--

A.3. Basic Experiments

The institute has a very strong experimental program on fundamental plasma sciences. This exciting programme caters mostly to the requirements of Ph.D. student programme. The current programme has experiments under the following heads:

A.3.1 Large Volume Plasma Device (LVPD) Experiment	29
A.3.2 Basic Experiments in Toroidal Assembly(BETA)	31
A.3.3 Interaction of Low Energy Ion & Neutral Beams with Surfaces	32
A.3.4 System for Microwave Plasma Experiments (SYMPLE)	32
A.3.5 Plasma Wake-Field Acceleration Experiment (PWFA)	34
A.3.6 Magnetized Linear Plasma Device	35
A.3.7 Experiments on Dusty Plasmas	36
A.3.8 A Linear Helicon Plasma Device With Controllable Magnetic Field Gradient	36
A.3.9 Non-Linear Dynamics In Dc Glow Discharge Plasma	37
A.3.10 Multi-cusp Plasma Experiment	37
A.3.11 Non-Neutral Plasma Experiment (SMARTEX-C)	37
A.3.12 Plasma Torch Activities	38

A.3.1 Large Volume Plasma Device (LVPD)

Experimental investigations in LVPD are focused this year on four fronts, namely (i) Plasma transport in the background of Electron Temperature Gradient (ETG), (ii) Understanding plasma turbulence in source plasma of LVPD, (iii) Developmental work, dedicated mainly towards augmentation of 40 channel data acquisition system and (iv) diagnostics development.

Plasma Transport in the background of Electron Temperature Gradient Driven Turbulence in Target Plasma:

An attempt was made to understand the effect of Electron Temperature Gradient Driven Turbulence experimentally, on particle transport in terms of turbulent particle flux in the core region of target plasma in LVPD [see figure A.3.1.1]. The core region exhibits radial gradients in electron temperature profile and no significant gradient in the plasma density and potential profiles. Also, this region exhibits fluctuations in plasma density, floating potential, magnetic field and electron temperature in finite beta ($\beta \sim 0.6$) plasma conditions, where ETG conditions are satisfied in terms of density and temperature scale lengths. The threshold for ETG can be described as the ratio of plasma density and electron temperature gradient

Basic experiments help in understanding the various properties of plasma state in both of naturally occurring and man-made ones. Apart from helping to develop various based technologies, they also help in developing the human resources for future endeavours.

scale length and its values should always exceed $2/3$. The region of target plasma, where ETG is successfully excited is formed by the diffusion of source plasma across the localized transverse magnetic field ($B_x = 160$ G) produced by Electron Energy Filter (EEF), when EEF is ON [see figure A.3.1.2]. The ETG region exhibits strong out of phase correlation between the density and potential fluctuation. These characterize ETG driven turbulence. The phase angle between density and potential fluctuations satisfy the ion non-adiabatic response. Fluctuation induced plasma transport in LVPD has shown an interesting result in the form of inward particle flux when only electron temperature has a gradient. We categorised LVPD plasma differently for two conditions imposed

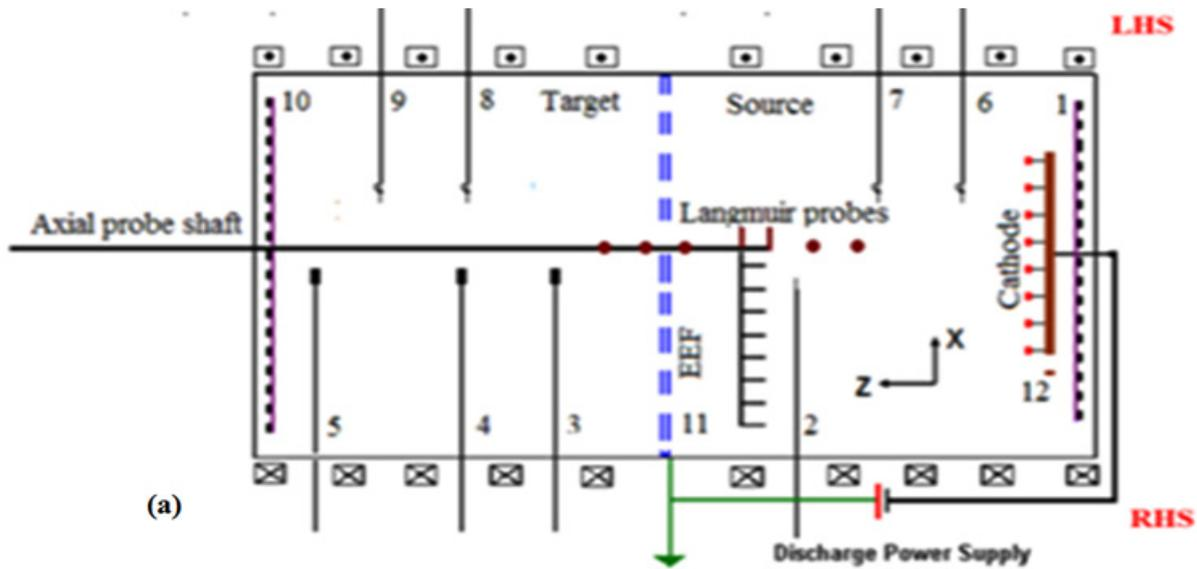

Figure A.3.1.1 Schematic view of Large Volume Plasma Device (LVPD) experimental system

on EEF. They are when EEF is active we call it as EEF ON plasma and when EEF is inactive, name given is EEF OFF plasma. When EEF is OFF, plasma density and temperature profiles does not satisfy ETG threshold conditions, also in this case density and potential fluctuations remains uncorrelated. Hence, no significant particle flux is observed for non ETG case.

Turbulence in the Source region: During this period, the right hand side (RHS) energetic electron belt in the source plasma of LVPD is probed with various modified Langmuir

probe diagnostics. The RHS energetic belt has significance of enhanced turbulence level with strong negative cross correlation between plasma densities, magnetic ($C_{(n,B)} \sim -0.8$) as well as potential ($C_{(n,\phi)} \sim -0.7$) fluctuations. Experiments were mostly carried out to trace the exact driver for the excited turbulence with 1) modified Katsumata type of probe, 2) MACH probes, 3) concentric ring and disk probe assembly in MACH probe configuration. The results obtained from these diagnostics inferred to the i) significant presence of energetic electrons in the belt region, ii) enhanced turbulence level when electron energy filter (EEF) is activated (Figure A.3.1.5). From the magnetic field point of view, the energetic belt region has two dimensional boundaries between the EEF and the source filaments. The boundary at EEF is having a high magnetic field corresponds to the axial magnetic field of LVPD and the filaments are negatively biased. At the EEF boundary, it is considered that the plasma in the belt region experiencing a loss cone and a fraction of the electrons are trapped and reflected back. The experimental evidence is confirmed with rise in plasma density, electron temperature, enhanced floating potential, and increase in turbulence levels. These observations are being consolidated for trapped/loss cone instabilities observed in plasmas. These kinds of instabilities are well related to the whistler phenomena's observed in earth's magneto sphere. Apart from the instability studies, plasma flow studies were carried out in source, EEF and target plasmas simultaneously with MACH probes. This has given a clear idea on plasma flow setup with activated EEF and how the plasma flows from the source region, inter-

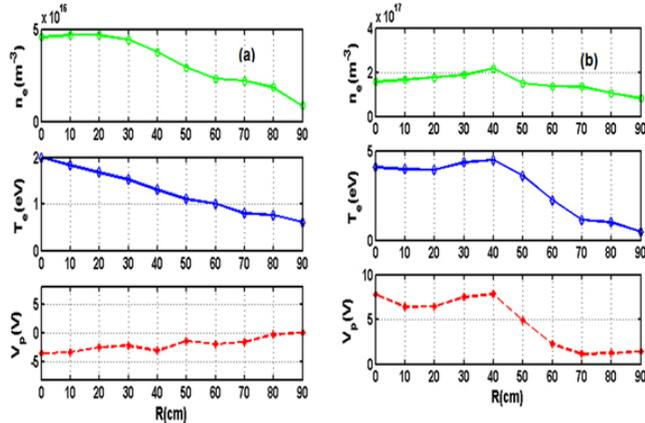

Figure A.3.1.2 Radial Profiles showing ETG suitable (EEF ON) and unsuitable (EEF OFF) profiles of plasma density, electron temperature, and plasma potential.

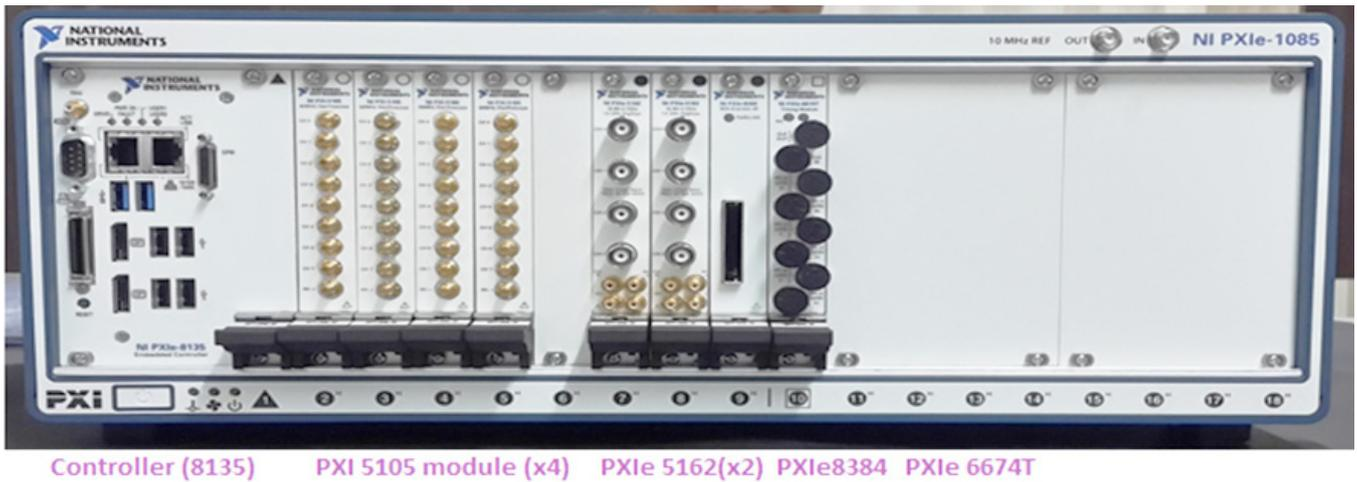

Figure A.3.1.3 The PXIe based DAQ hardware procured as LVPD data acquisition system



Figure A.3.1.7.

A.3.2 Basic Experiments In Toroidal Assembly (Beta)

acts with the EEF plasma and thereafter diffuses to the target plasma. Plasma diffusion across the complete EEF length investigated for understanding the cross field diffusion behaviour. Apart from these, near EEF target plasma profiles were characterised and the experiments are being done to establish a correlation between the near EEF target plasma and the electron gradient driven turbulence (ETG) relevant plasma observed at a far target (axially ~90cm) region of LVPD. This study will give information of control and development of ETG type of profiles.

System Up gradation: Procurement and Augmentation of 40 channel, PXI based Data Acquisition System: The data acquisition and control system up gradation for the large volume plasma device has been upgraded using procurement of the off-the-self hardware and in-house developed software solutions. Recently, a 40 channel fast data acquisition system on PXIe bus (see figure A.3.1.3) is integrated with the machine. A dashboard for signal configuration and signal visualization is developed in Lab VIEW toolkit. Further, this system has been integrated with machine automation system for high current filament powering supply) and probe positioning system on Modbus protocol.

Diagnostics development: A triple probe has been fabricated for real time, measurements of temperature fluctuations. Temperature fluctuation measurements will be used to quantify the energy flux. For establishing the triple probe (TLP) technique, we compared the mean electron temperature with

In a simple toroidal device, the plasma profiles and properties depend on toroidal magnetic field topology. For example, the toroidal connection length crucially controls the adiabatic or non-adiabatic nature of electron dynamics, which in turn governs the nature of instabilities, fluctuations and transport, the latter of which governs the plasma mean profiles. We discuss results of extensive experiments in a simple toroidal device obtained by controlling the mean parallel connection length L_c of magnetic field B_v , where $B_v \leq 2\%$ of toroidal magnetic field B_T . Interestingly, for nearly closed field lines, which are characterized by large values of L_c , it is found that flute-like coherent structures are observed to be dominant and is accompanied by large poloidal flows. For small values of L_c , the mean density on the high field side (HFS) is seen to increase and net poloidal flow reduces while at the same time a turbulent broad band in fluctuation spectrum is observed. Upon a gradual variation of L_c changes in mean plasma potential and density profiles, fluctuation and poloidal flows demonstrates that in a simple toroidal device there exist a strong relationship between L_c , flows and fluctuations. Net flow measured is found independent of the direction of B_v , but an asymmetry in the magnitude of the flow is found. The observed imbalance between the mean flow, fluctuation driven flow and net flow were also addressed.

A.3.3 Interaction Of Low Energy Ion & Neutral Beams With Surfaces

A neutral beam observation system based on micron channel plate (MCP) / phosphor screen has recently been procured. It is a stand-alone system with imaging diameter of 18mm. It has a gain which is in excess of 10^7 and can detect neutral or ion beam with energy range from 1 eV to 50 keV. Our neutral beam is expected to be the range of 5-100eV, hence it can easily be detected and imaged. However, for this beam observation to function properly, it requires vacuum which is better than 1×10^{-6} mbar. The earlier sub-system for the neutral beam detection using a mass spectrometer utilized an oil diffusion pump in conjunction with vane rotary pump. It gave an ultimate vacuum of 5×10^{-6} mbar which was not suitable for MCP / phosphor screen based observation system, hence needed to be replaced. A new vacuum sub-subsystem using conflat flanges and copper gaskets for housing the neutral beam observation system has been designed and got fabricated at our workshop. Honing, buffing and electro-polishing have been carried out at an outside facility. For pumping, a turbo pump and a dry scroll pump have been procured. The sub-system has just been assembled. After thorough leak tests for no-leaks and baking at 200°C for a few hours it is expected that the ultimate vacuum in the sub-system can be reached in the range of $1-5 \times 10^{-8}$ mbar. After that, the new beam observation system will be placed inside the vacuum sub-system and then the sub-system will be connected to the main high density plasma beam vacuum chamber for neutral beam observation experiments to commence.

Variety of small experiments are running in the institute which caters mainly to the Ph.D. programmes and keep the excitations of small physics vibrant throughout the year.

A.3.4 System For Microwave Plasma Experiments (Symple)

The experimental works carried out this year in both Phase-1 and Phase-2 systems of SYMPLE include the following: (i) Enhancements in the plasma characteristics, (ii) Setting up of calibration systems for high frequency diagnostics, (iii) Design and fabrication of a TE₁₀ – TM₀₁ HPM Mode Converter and (iv) Studying various schemes for Phase-2 HPM-plasma coupling with the help of analytical and simulation works and initiating fabrication of coupling components.

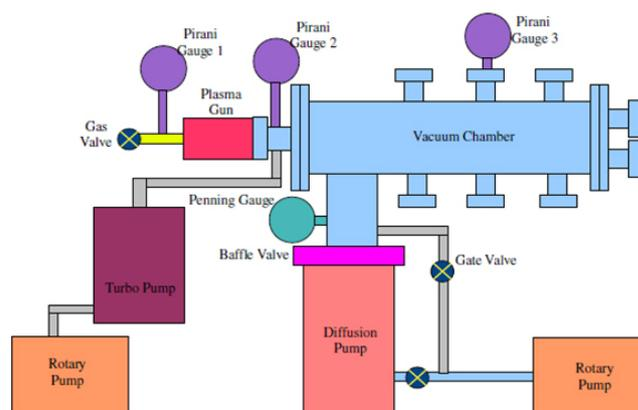

Figure A.3.4.1 Experimental set up showing the differential pumping between the plasma source chamber and experimental chamber

Enhancements in the plasma characteristics : By trying various ways of differential pumping and finalizing on a most appropriate scheme, the working pressure in the experimental chamber has been brought down by two orders of magnitude, from 1×10^{-1} mbar to $< 1 \times 10^{-3}$ mbar. The scheme adopted, installing a Turbo pump between the two chambers is shown in Figure A.3.4.1 . An enhancement in density, by more than an order of magnitude in comparison with the density obtained with higher working pressure was thus obtained.

Development of a Transverse Electromagnetic (TEM) cell for calibration of high frequency diagnostics: In order to carry out the calibration of various types of high frequency (~ a few Gega Hertz) E-dot and B-dot probes fabricated in-house by us, a TEM cell has been designed and developed. A TEM cell is nothing but a kind of rectangular coaxial transmission line tapered from both ends to attain 50Ω coaxial



Figure A.3.4.2 The TEM cell developed for calibration of high frequency diagnostics

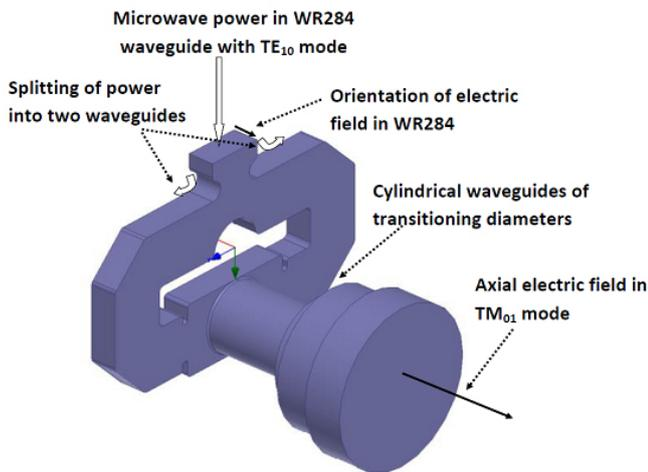

Figure A.3.4.3 The geometry designed for the mode converter.

connections. It is a two ports device and consists of a center conductor called septum and two outer conductors equally spaced from the septum. Applying an input pulse (nano second), the position dependent electric field and magnetic field values within the cell can be easily estimated and this cell can be used to calibrate the diagnostic probes. Figure 2 shows a photograph of the TEM cell developed. Excitation and measurement of electromagnetic fields are presently under way

Design and Development of a TE10-TM01 HPM Mode Converter:

The 3 GHz, 3MW magnetron to be used for the

Phase-1 SYMPLE experiments has its output in the TE10 mode. As it is required that the electric field of the wave be in parallel direction to the plasma column, an HPM TE10 to TM01 mode converter that is compatible with 4 MW peak power and 5 bar pressure (of SF6 gas used in the coupling section), has been designed and tested. The geometry, shown in Figure A.3.4.3 is designed in such a way that the transverse electric field is rotated by 90 degrees to get its direction parallel to the plasma column axis. The rectangular waveguide input is at the top and it is split into two equal parts which arrive at the same instant of time at the input to the circular waveguide exciting the TM01 mode in a circular waveguide. The circular waveguide axis coincides with the plasma column axis. The diameter of the circular waveguide (88 mm) is stepped up to 300 mm to interface with the plasma chamber. The mode converter is designed for an operating center frequency of 3 GHz, return loss > 20 dB for +/- 20 MHz around the center frequency, and a return loss of > 15 dB for +/- 35 MHz around the center frequency. A photograph of the fabricated mode converter is shown in Figure A.3.4.4. Two mode converters are fabricated for the purpose of experimental characterization. The S11 and S12 measurements have to be necessarily performed on two mode converters as it is impractical to evaluate the performance of a single mode converter. The two mode converters are assembled and connected back to back as shown in Figure A.3.4.4 (b) for



Figure A.3.4.4 The fully assembled mode converter (a) and two mode converters assembled and connected back to back (b) to perform S11 and S12 measurements.

carrying out the return loss and insertion loss measurements.

HPM Coupling Schemes for Phase-2: Various schemes are being studied for the HPM (1 GW) coupling to plasma, to measure the forward and reflected power and to carry out matching. This schemes generally include the microwave transmission line, directional coupler and stub tuner along with other components for testing like load and isolator. Various types of directional coupler were tried which include loop type, multi-hole, Bethe-hole and fixed probe type. The fixed probe type gives best results for directivity and coupling.

A.3.5 Plasma Wake-Field Acceleration Experiment (PWFA)

LINAC building: The prime goal of accelerator programme at IPR is to establish a 50 Mev (3 ps) electron beam LINAC facility and demonstrate an electron acceleration gradient of ~ 25 Mev/m in the Plasma Wake Field Acceleration (PWFA) experiment which is being currently pursued. As a part of this ongoing project, the site allotment for the LINAC facility has been done and site clearance has been obtained from

Atomic Energy Regulatory Board (AERB). The LINAC system consists of electron gun, LINAC tube, beamlines, RF sources, etc. A radiation shielding calculation for the LINAC facility was carried out to optimize and design the layout for the LINAC facility. The initial layout of LINAC system, its subsystems and different beamlines has been finalized. The LINAC layout including the proposed beamlines and building requirements is shown in figure A.3.5.1. The two storeys LINAC building houses the laboratories and control room for PWFA experiment and LINAC system in the ground floor, and the user labs for developmental work and office space in the first floor. The beam optics design for bending/ quadrupole magnets and low energy beamline for the LINAC system has been initiated in collaboration with RRCAT, Indore.

Experiments: The Lithium vapor density characterization studies of the prototype plasma source (40 cm long Li based photo-ionized heat pipe oven) for the proposed PWFA experiment has been carried out with three different optical diagnostics methods (white light, UV absorption and Hook method) as a function of external heat pipe oven (HPO) temperature and Helium buffer gas pressure in the HPO. Hook

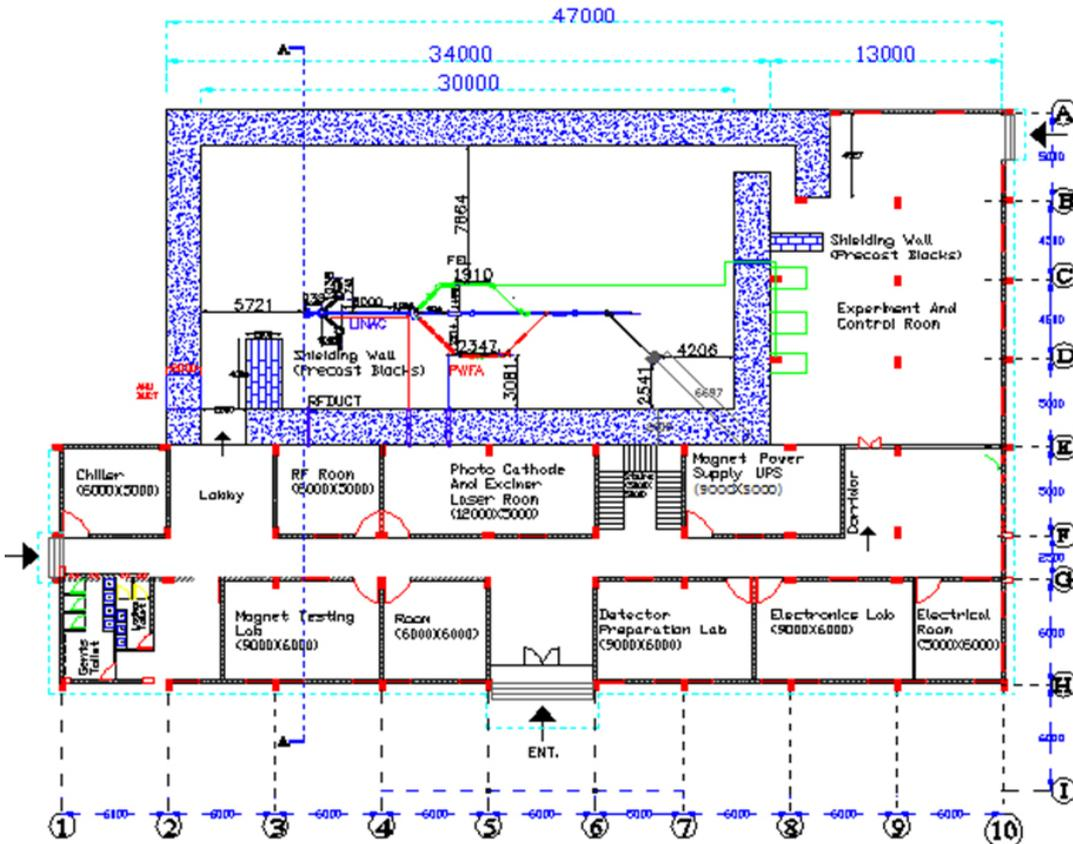

Figure A.3.5.1. IPR LINAC building layout as it is planned now for ground floor

method (Spectrally resolved white light interferometry) has been successfully implemented in the laboratory for the first time for an accurate measurement of the line integrated Li vapor density along the HPO longitudinal axis. Figure A.3.5.2 shows a typical Hook interferogram recorded at different external HPO temperature (200 mbar of Helium buffer gas pressure). Systematic experimental studies to measure Li vapor density in the HPO were carried out using this Hook setup. Also simultaneously Li vapor density measurements were carried out using white light absorption and UV absorption techniques under similar experimental conditions. A comparative study was carried out to derive a calibration plot for UV absorption data from the Hook measurements. The design and fabrication of the one meter long Li based plasma source has been initiated. Experiments for setting up CO₂ interferometer to measure the line integrated plasma density in the Li heat pipe oven has been initiated. The design and characterization studies of the CO₂ optical components are in progress.

A.3.6 Magnetized Linear Plasma Device

Well characterized/reproducible plasma systems are necessary to validate/benchmark various physics models/diagnostics concerning the plasma-wall interface. A new plasma device named APPEL (Applied Plasma Physics Experiments

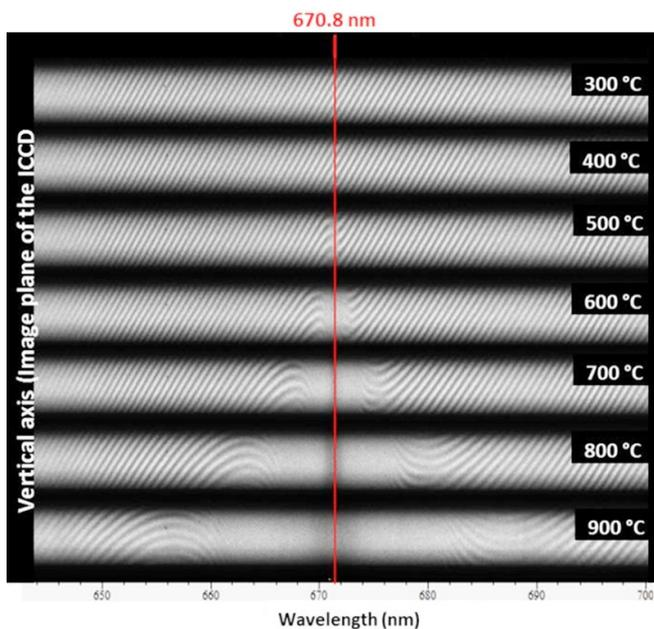

Figure A. 3.5.2. Hook Interferogram recorded at different external temperatures of the heat pipe oven ($P_{\text{Helium}} = 200 \text{ mbar}$)

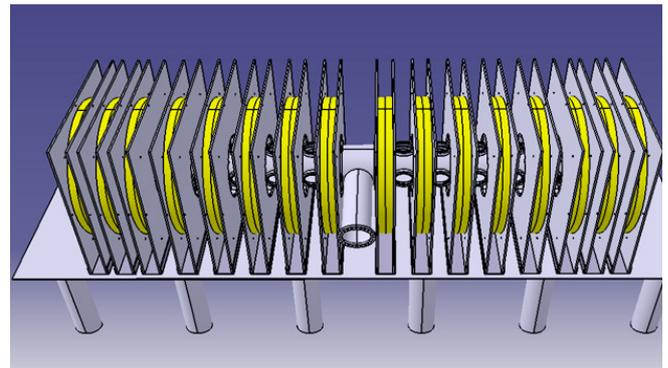

Figure A. 3.6.1 Schematic of the APPEL showing the configuration of 16 electromagnets (combination of two double pancakes)

in Linear Device) is being developed for investigating the behavior of intensely magnetized plasma and its interaction with external electrodes in the laboratory. The device will provide steady state, high density magnetized plasma confined in a magnetic mirror. To study the effects of oblique magnetized sheaths adjacent to a dc/radio-frequency driven electrodes, a new magnetized CCP (Capacitively Coupled Plasma) set-up has been developed. The device shall be used to validate 2-dimensional PIC simulation results in collaboration with Dublin City University, Ireland. In conjunction, experiments to study the fundamental behavior of sheaths in presence of negative ion containing plasmas are currently in



Figure A. 3.6.2 Experimental set-up for investigating oblique magnetized sheaths



Figure A. 3.6.3 Pin-plane probe for investigating magnetized plasmas

progress. These plasmas have application in the production of neutral beams for heating and current drives in tokamaks. A number of concepts for producing high density plasma based on transverse electric and magnetic fields are being investigated for application in controlled high heat flux plasma material interaction experiments in the controlled laboratory. For investigating the properties of complex plasmas consisting of multi-ion species, strong magnetic fields, large oscillations/ fluctuations in plasma potential, charge particle beams etc; a major focus has been dedicated towards in-house development of plasma diagnostics such as microwave resonator probe, pin-plane probe, and time-resolve technique to determine temporal variation in plasma discharges. Electronics hardware and software for the analysis of single/dual/triple Langmuir in magnetized plasma has been developed for precise analysis of voluminous data from different physics experiments.

A.3.7 Experiments On Dusty Plasma

Dusty plasma (complex plasma) is a four component plasma, consisting of electrons, ions, neutrals and charged dust particles. These are ideal systems for modelling nanofluids, phase transitions, transport process, crystal structure etc. The dusty plasma system exhibits different collective effects, for instance vortices, waves, etc. Study of collective effects in dusty plasma is particularly rewarding as one is able to study both the collective effects and motion of the individual micron sized charged dust particles constituting the collective phenomena. The cause of formation of dust vortices and its evolution on changing ambient plasma conditions is under investigation. These studies are being carried out in Complex Plasma Experimental Device (CPED) which was specifically designed to serve as a test bed for the study of vortices. The study of these vortices are particularly very important be-

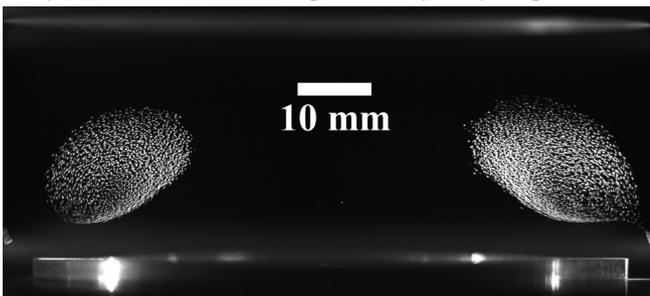

Figure A.3.7.1 The laser sheet is illuminating the dust torus along its diameter that allows us to see diametrically opposite two poloidal cross-sections which basically look like two vertical dust vortices

cause vortices are observed in a number of physical scenarios like smoke rings, wing tips of aircraft, great red spot of Jupiter, etc. A good understanding of the physics of vortices will enhance our understanding of basic physics.

A.3.8 A Linear Helicon Plasma Device with Controllable Magnetic Field Gradient

Basic plasma research has been carrying out in the expanding Helicon eXperimental (HeX) plasma system, where plasma expanded from a narrow source to wide expansion chamber. Students are involved to carry out their doctoral studies on several problems such as left polarized wave absorption near electron cyclotron resonance frequency, multiple density peaks due to resonance phenomena at low magnetic fields, dielectric wall charging, resolving electron temperature anomaly in triple probe, Landau damping helicon wave interaction for electron heating etc over the last several years. In this academic year the research focused primarily on the study of transition from single to multiple axial potential structures (MAPS) formation, downstream annular plasma formation and generation of edge localized hot tail electrons. Moreover, generation of supersonic ions and detecting them using a novel retarding field energy analyzer (RFEA) is a most awaited achievement in HeX machine to fulfil one of its primary goals. Two temperature electrons are observed in our low density helicon antenna produce 13.56MHz radio-frequency plasma. Hot electrons are observed only at off-axis by the two techniques. Both cold and hot electron temperatures, estimated by applying two techniques (from semi-logarithmic plot and analog electron energy probability function (EEPF) measurements), are found to be in close agreement. On-axis measurement does not show any indication of presence of energetic electrons. Underline mechanism for this off-axial hot tail electron observation is governed by the way of RF power coupling. Introducing an RF current to an antenna, where the changing magnetic field associated with the antenna current induces an electromagnetic field in the similar way of transformer action to couple RF power. Depending on the coupling mechanism of the RF fields to the plasma, the discharge has been classified into three modes. Electrostatic coupling of RF power with the plasma is called as E-mode and electromagnetic coupling of RF power with the plasma is named as H-mode. In presence of external static magnetic field, these electromagnetic disturbances can propagate at low frequencies (compare to electron plasma frequency: ω_{ep}) and charge particles can absorb energy from these waves, called W-mode or wave coupling. Distinct density jumps are the representation of transition from one mode to

another either by increasing RF power or strength of external magnetic field. Transition of all three modes (E-H-W) with increasing magnetic field is observed in HeX system. Moreover a Matlab code is developed, incorporating the existing theoretical model for radially nonuniform density cylindrical plasma to carry out study of polarization reversal. The radial profiles of helical wave magnetic field component B_r , B_θ and B_z , and phase profile of same are computed for different radial density profiles. Our results show the polarization (or phase) of wave gets reversed at certain radial location. The zero crossing of amplitude of radial azimuthal component (B_θ) is related to wave polarization reversal. The location of polarization reversal can be controlled by the radial wavelength and nonuniform density profile.

A.3.9 Non-Linear Dynamics in DC Glow Discharge Plasma

Chaotic mediums are widely appears in the nature. The study of any chaotic mediums is very tedious work. A deterministic system is said to be chaotic whenever its evolution sensitively depends on the initial conditions. A simple DC glow discharge system is used for study of Chaos and nonlinear dynamics. Physics behind the nonlinearity and state of chaos is still the subject of intense study. Currently we are carrying out experiments related to chaos in the DC glow discharge system present in basic lab. Discharge is struck by applying the dc voltage between two metal electrodes and diagnosed by current probe and array of photodiodes. The observation for Paschen curve and I-V characteristics are made to characterize the dc discharge. The presence of hysteresis in I-V characteristics. Observations of moving and stationary striation are also made. We also verified the Goldstein–Wehner law for the stratified positive column, which state the dependency of striations length on tube radius and pressure. These experiments are being carried out by the post graduate students from university as a part of their project work. AC fluctuations over dc current as well as AC fluctuations of floating potential are being studied in order to carry out experiments on frequency pulling. The photodiodes measure the discharge light fluctuation. For the fixed 60 cm separation many time series signals have been taken under different parametric condition. Currently we are analysing the data. Electronics required acquiring these signals through a DAQ system is almost ready and will be used for further experiments.

A.3.10 Multi-Cusp Plasma Experiment



Figure A. 3.10.1 Argon plasma in a profiled multi-cusp magnetic field.

The I-type flange was designed, fabricated and tested for the required vacuum. Then the target plate was heated by indirect heating as planned. With some modifications, the heating of the plate was found to be uniform. But the required temperature could not be achieved, since at higher biasing voltages arcing was observed. Now the designs of the insulators are being newly looked into to avoid this arcing. In the mean with the already attained temperature, argon plasma was produced and it is being characterized. The visual appearance of the argon plasma clearly shows the profiled magnetic field as shown in the figure A.3.11.1. The characterization of this argon plasma is in progress, which has given many interesting observations. Efforts are on to publish these observations with possible explanations. The welding (molybdenum to molybdenum) of the nozzle pipes to the delivery piped ring has been attempted. It was found the welding was not proper and it has some leaks. The leaks are being fixed and it will be tested for the required high operating temperature as well as uniform gradient temperature all along the delivery pipes starting from the cesium oven to the nozzle to be held close to the hot ionizer plate.

A.3.11 Non-Neutral Plasma Experiment (SMARTEX-C)

New electronic-circuits like Comparator, Active voltage attenuators, Transient voltage suppressor and FPGA based

trigger as well as associated power supplies have been developed in house. Circuit with provision of multiple inject-hold-dump cycles and its integration with main LabVIEW® based control system of SMARTEX-C has also been completed. Support structure of entire SMARTEX-C has been developed with added features. In trap components have been redesigned and fabricated in order to remove shortcomings. A new TF coil has been designed having silver plated copper conductor (AWG 2). Characterization of ion-resonance and resistive wall instabilities in a Nonneutral, pure electron plasma has been done and analysis is being continued.

els for simulating plasma conditions for various applications. The plasma torch laboratory now boasts of the capability of building high power plasma torches by using a combination of predictive scaling laws, computer modelling and physics understanding.

--!!!--

A.3.12 Plasma Torch Activities

Development Work: Developmental work on high power torches was carried forward. Steady-state plasma torch operation was demonstrated at 80 kW power. Enthalpy probe was put up for commercialization. The probe can measure hot gas/plasma temperatures ~2000–10000 K and enthalpies ~MJ/kg. The design is novel; probe can be built in-house and is very cost-effective (approx. 10 times lower than global players). Local industry has evoked interest in buying the technology.

Fundamental studies: The dynamics of plasma arc root and column in the torch was investigated using combination of magnetic (to pick up transients in return current) and fast imaging diagnostics (to capture end-on images) simultaneously. Many interesting results have emerged, throwing light on the role of external magnetic field, current density and flow on the arc dynamics. Results have also revealed the three-dimensional nature of arc column as speculated earlier. Close correlation was observed between magnetic and imaging diagnostics, paving the way for possible magnetic tomography of such plasmas, which may help in achieving better process control for a thermal plasma application. Another experiment was set up with a view to investigate the role of fluid dynamic configurations on torch efficiency. Novel gas flow configurations were incorporated in the plasma torch with flexibility to quickly change from one configuration to another.

Plasma torch modelling: Several plasma torch models were developed using both commercially available CFD packages and computer codes developed by University of Texas at Austin (UT) with whom collaborative work has been initiated. IPR has been provided with free academic license of the code that will be used to continue the simulation of plasma torch for various geometries and experimental conditions. UT will also help IPR develop its own computational mod-

A.4. Theoretical, modeling and Computational Plasma Physics

Plasma physics requires a very intense computational capability for its modelling and simulation program. The institute has developed a versatile computational facility in many years. At present work is being done in the the following heads:

A.4.1 Non-Linear Plasma Studies and Simulation	39
A.4.2 Laser Plasma Studies	40
A.4.3 Dusty and/or Complex Plasma Studies	41
A.4.4 Fusion Plasma Studies	41
A.4.5 Global Gyro-kinetic Studies	42
A.4.6 Non-neutral Plasma Studies	42
A.4.7 Molecular Dynamics (MD) Simulations	43

A4.1 Non-Linear Plasma Studies and Simulation

Effect of driving frequency on the electron-sheath interaction and electron energy distribution function in a low pressure capacitively coupled plasmas: The effect of driving frequency (27.12-70MHz) on the electron energy distribution function (EEDF) is investigated in a low pressure capacitively coupled plasma discharge using a self-consistent particle-in-cell/ Monte-Carlo collision (PIC/MCC) simulation. At a fixed discharge voltage the EEDF evolves from a strongly bi-Maxwellian at low driving frequency, 27.12MHz, to a convex type distribution at an intermediate frequency, 50MHz, and finally becomes a weak bi-Maxwellian at a higher driving frequency i.e. above 50MHz. The EEDF evolution leads to a two-fold increase in the effective electron temperature up to the transition frequency, 50MHz, whereas, electron density remains constant in this range. After the transition frequency the electron density increases rapidly and the electron temperature decreases. The transition is caused by the transient electric field excited by the bursts of high energy electrons interacting strongly with the sheath edge. Above the transition frequency, the high energy electrons are confined between two opposite sheaths which increase the ionization probability and thus plasma density increases.

Collisionless sheath features of capacitively coupled plasma discharges operating with current driven triple frequency configuration: The CCP (Capacitively coupled plasma) discharge features operating in current driven triple frequency

configuration has analytically been investigated and the outcome is verified by utilising 1D3V particle-in-cell (PIC) simulation code. In this analysis the role of middle frequen-

Scientific simulation, which provides a natural bridge between theory and experiment, is an essential tool for understanding complex plasma behaviour. Hence the institute has been developing a versatile computational facilities which are ever growing

cy component of the applied signal has precisely been explored and the discharge parameters are seen to be sensitive to the ratios of the frequency (and current) components. On the basis of analysis and PIC simulation results, the middle frequency component is demonstrated to act as additional control over sheath potential, sheath heating and ion energy distribution function (iedf) of the discharge; the effect of the middle frequency is seen to be pronounced as it approaches to lower frequency component. The PIC estimates for sheath heating is found to be in reasonably good agreement with the analytical prediction based on Kaganovich formulation.

Collisionless sheath heating in CCP discharges via higher order sinusoidal signals: Collisionless heating of the electrons in the vicinity of sheath region corresponding to higher order sinusoidal signal in a current driven radio frequency

capacitively coupled plasma (RF-CCP) discharge has been investigated analytically and further verified by particle-in-cell (PIC) simulation. The simulation results for collisionless sheath heating are found to be in good agreement with analytical predictions. In contrast to voltage driven case it is demonstrated that a pure sinusoidal waveform gives maximum electron sheath heating with current driven configuration and the ion energy can be controlled by varying the pulse width while keeping plasma (ion) density constant.

Nonlinear kinetic model of waves and turbulence in hot collisionless plasmas: The evolution and mutual interaction between the nonlinear solitary electron hole (SEH) structures is studied in the electron acoustic regime by means of Vlasov simulations. The high phase-space resolution simulations show signatures of turbulence in the small amplitude, conventionally linear, regime where it is governed by the trapped particle nonlinearity capable of operating on the infinitesimal amplitude of perturbation. The independent and interacting phases of the SEH are observed to closely correspond to detection of nonlinear coherent potential structures in magnetospheric plasmas supplementing the conventional turbulent activity in the space and magnetospheric plasmas.

Fluid simulation of relativistic electron beam driven wakefield in a cold plasma: Excitation of wakefield in a cold homogeneous plasma, driven by an ultra-relativistic electron beam is studied in one dimension using fluid simulation techniques. For a homogeneous rigid beam having density (n_b) less than or equal to half the plasma density (n_0), simulation results are found to be in good agreement with the analytical work of Rosenzweig. Here, this work has been analytically extended to regimes where the ratio of beam density to plasma density is greater than half and results have been verified using simulation. Further in contrast to Rosenzweig's work, if the beam is allowed to evolve in a self-consistent manner, several interesting features are observed in simulation viz. splitting of the beam into beam-lets (for initial beam length $>$ plasma wavelength) and compression of the beam (for initial beam length $<$ plasma wavelength).

A.4.2. Laser-Plasma Studies

Polarization dependent energy absorption in the laser-bacteria interaction (with TIFR): Recently we have studied ion acceleration from laser-driven bacteria coated target with p-polarized light. Ion-acceleration has been studied further by varying polarization state of light experimentally at TIFR. Two and three dimensional particle-in-cell (PIC) simulations

have been carried out to reproduce those experimental results at IPR. Higher acceleration of electrons is obtained with bacteria coated target at an oblique incidence of 45 degree. Electron yield is calculated with increasing number of ellipsoids on a slab surface. The key mechanism of absorption is identified as an-harmonic resonance.

Ion acceleration using nano-pore (nano-hole) solid surfaces (with TIFR): In the laser-plasma based ion acceleration schemes, generally all ionic species of the same charge-to-mass ratio are equally accelerated in the transient longitudinal static electric field formed by the interaction of intense laser with solids. Here, acceleration is seldom mass-selective. The possibility of manipulating such ion acceleration schemes to enhance the energy of one ionic species (either proton or carbon) selectively over another is investigated experimentally in TIFR with nano-pore targets (targets with nano-holes). It is shown that the pore diameter serves as the tuning parameter. At some near relativistic laser intensity the acceleration is found to be optimum for protons when the pore diameter is nearly 15-20 nm and it is favourable for carbon ions when the pore diameter is approximately 60 nm. At IPR, 2D-PIC simulations (with EMPIC2D code) have been carried out taking into the TIFR experimental conditions. Main experimental results have been reproduced by PIC simulations.

Collisional absorption of laser pulse in plasma using Monte Carlo and PIC simulations: Earlier collisional absorption (CA) of a laser light in a homogeneous, under-dense plasma-slab due to electron-ion collision has been studied by using classical and quantum kinetic approaches. It was found that for low laser intensities and low electron temperatures absorption may increase (instead of conventional decrease of absorption with increasing laser intensity). In the present work we are interested to find the anomalous CA (mentioned above) using more appropriate PIC simulations. For this purpose an one-dimensional (1D) electromagnetic particle-in-cell (EMPIC1D) code including Monte Carlo binary collisions has been developed. Collisional absorption has been studied in detail at different laser intensities and anomalous collisional absorption is finally identified with this Monte Carlo collision assisted PIC simulations, compared with experiments and earlier theoretical results. Thus anomalous CA is unequivocally proved by theory and simulations.

Investigation of shock-shock interaction and Mach reflection in laterally colliding laser-blow-off plasmas: Interactions of two Li plasma plumes and shock waves are investigated

at various pressures (10^{-5} to 3 mbar) in the argon gas ambient. Fast imaging and optical emission spectroscopy are used to study the plume dynamics and characteristic emission of plasmas. The plasma plumes are created in laser-blow-off geometry. The expansion of plasma plumes in the ambient gas leads to the formation of an interaction zone. The formation of interaction zone is dependent on the ambient pressure and below a certain pressure, no significant change is observed in the shape and size of the interaction plasma. In the higher pressure, formation of interaction zone and its shape are dependent on ambient pressure. Dynamics of seed plasmas and interaction zone are also affected by the shock-shock interactions. The shock-shock interaction depends on the angle of incidence (α) between two shock waves at the initial time of interaction but as the plumes expand, the shock-shock interaction does not follow α dependence.

Radiation reaction effect on laser driven auto-resonant particle acceleration: The effects of radiation reaction force on laser driven auto-resonant particle acceleration scheme are studied using Landau-Lifshitz equation of motion. These studies are carried out for both linear and circularly polarized laser fields in the presence of static axial magnetic field. From the parametric study, a radiation reaction dominated region has been identified in which the particle dynamics is

Through collaboration, the results from the experiments at TIFR, Mumbai are being explained by theory and simulation which are being done by the group at this institute

greatly effected by this force. In the radiation reaction dominated region, the two significant effects on particle dynamics are seen, viz., (1) saturation in energy gain by the initially resonant particle and (2) net energy gain by an initially non-resonant particle which is caused due to resonance broadening. It has been further shown that with the relaxation of resonance condition and with optimum choice of parameters, this scheme may become competitive with the other present-day laser driven particle acceleration schemes. The quantum corrections to the Landau-Lifshitz equation of motion have also been taken into account. The difference in the energy gain estimates of the particle by the quantum corrected and classical Landau-Lifshitz equation is found to be insignificant for the present day as well as upcoming laser facilities.

A.4.3 Dusty and/or Complex Plasma Studies

Analytic structure of the vortex dynamics of a driven dusty fluid in plasma: Flow structure of a dust medium electrostatically suspended and confined in a plasma presents a phase of coupled matter where the spatial scale of a volumetric drive by the plasma flow exceed that of the boundaries confining the dust. By means of the first formal implementation of 2D hydrodynamic model to a confined dust flow and its analytic curvilinear solutions, the present study shows that the eigenmode spectrum of the dust vortex flow can lose correlations with the driving field even at the low dust Reynolds numbers as a result of strong shear and finer scales introduced in the equilibrium dust vorticity spectrum by the boundaries. While the boundary effects can replace the desired turbulent processes unavailable in this regime, the shear observable in most of the dust vortex flows is identified to have a definite exponent of dependence on the dust viscosity over a substantially large range of the latter. These results and scalings allow quantification of the notion of dusty plasma medium as a paradigm for a wide range of natural flow processes having scales inaccessible to ordinary laboratory experiments.

Dusty plasma experiments and their modelling: An interesting analytic result from the 2D analytic formulation of the confined dust set-up was jointly verified by the dusty plasma experiments in the Basic Experiment Laboratory of IPR where generation of multiple vortex were recovered in presence of a non-monotonic sheared drive of the dusty fluid. This work has been already published in this year.

A.4.4 Fusion Plasma Studies

Fluctuation induced density scale variations in limiter SOL plasma transport simulations of Tokamak Aditya: The SOL widths derived from radial gradients allow direct estimations of diffusivity in limited and diverted plasmas. The radial variations in a limiter SOL can be modified by the 3D characteristics of the SOL transport as evident in tokamak Aditya where considerably large diffusivities are measured via multiple diagnostics. For a poloidal ring limiter generated SOL of circular plasma in Aditya tokamak, this variation is examined with respect to an effective anomalous cross-field diffusivity originating from the edge turbulence and fluctuations. The modulations in the configuration dominated parallel flow structures are smeared-off by the large fluctuations. The shear is however seen increasing with diffusivity in certain range of parameters. The density gradient scale length shows devia-

tion from the analytic model, arising from the finite poloidal flux contribution and affecting radial gradients. An irregular diffusivity dependence is recovered in scale lengths at downstream locations as compared to a more analytic variation at the upstream locations.

Study of Tearing Modes with equilibrium shear flows: We have worked on the understanding of the recent experimental observations related to NTMs stability in presence of plasma rotation as a part of ITPA-MHD TG Joint Activity1 (JA-1). The parts of the work were reported in the JA-1 in ITPA MHD TG meeting at ITER-IO, Cadarache, France on April 14-17, 2015 and in JA-2 in ITPA MHD TG meeting in Toki, Japan on March 21-23, 2016.

Study of Edge Localized Modes with Resonant Magnetic Perturbations: We are continuing our work using CUTIE to understand the dynamics of resonant magnetic perturbations (RMPs) and control of ELMs. We have applied $n=2$ static external magnetic perturbations to study the effect of RMPs on the dynamics of repetitive ELMs. We are trying to understand RMP results and decided to work further on it to study the influence of pellets etc. We are also working on the model equations for ELMs cycle model. We are developing a basic numerical code to solve the model equations. We have benchmarked earlier results to validate the code. Now we have made some progress for 1D ELMs model in slab geometry. Separate thermal cycle and current cycle have been observed. In thermal cycle, there is regular pulses but there

The potential applications of dusty plasma physics is tremendous in astrophysical problems as well as in the applied research related to materials sciences. In IPR, both experiments and theory with simulation studies are being pursued vigorously

are sharp pulses when current cycle dominates. In presence of anomalous viscosity in ohm's law, sharp pulse stabilize and more regular pulse observed.

Role of neutral gas in Scrape-off Layer of Tokamaks: Role of neutral gas in Scrape-off Layer (SOL) region of tokamak plasma is important as it is expected to modify the plasma

turbulence. This has been investigated using two models, namely strong interaction approximation where the neutrals are treated as diffusive fluid and weak interaction approximation where they are treated as a weakly ionizing mono-energetic beam. Two-dimensional (2D) equations have been used that consists of electron continuity, quasi-neutrality, electron energy and neutral gas continuity equations in the presence of neutral ionization. Further more neutral diffusion has been added for the strong interaction model. For the strong interaction case, growth rate obtained from these equations has been presented using linear theory. It is observed that the growth rate increases with the neutral gas diffusion and ionization coefficients. The nonlinear equations are solved numerically. Radial profiles of plasma density, electron temperature, and electric field have been obtained. It is found that the neutral gas reduces electric fields. More significant reduction of the poloidal electric field has been found by the neutral gas. Time series obtained from the numerical data have been analyzed. A strong decrease of fluctuations of the plasma has been found at the outer region the SOL plasma by the two models. In the weak interaction limit the effect of the neutrals is considerably reduced. 1D model of ELM-PB had been studied using model equations that consists of energy, electrostatic and electromagnetic relaxation equations. Basic features of the ELM-PB crash had been observed by this 1D model

A.4.5 Global Gyro-kinetic Studies

Gyrokinetic simulations of Microtearing Mode in large aspect ratio Tokamaks: Collisionless micro-tearing modes have recently been found linearly unstable in sharp temperature gradient regions of large aspect ratio tokamaks. The magnetic drift resonance of passing electrons has been found to be sufficient to destabilise these modes above a threshold plasma. A global gyrokinetic study, including both passing electrons as well as trapped electrons, shows that the non-adiabatic contribution of the trapped electrons provides a resonant destabilization, especially at large toroidal mode numbers, for a given aspect ratio. The global 2D mode structures show important changes to the destabilising electrostatic potential. The threshold for the onset of the instability is found to be generally downshifted by the inclusion of trapped electrons. A scan in the aspect ratio of the tokamak configuration, from medium to large but finite values, clearly indicates a significant destabilizing contribution from trapped electrons at small aspect ratio, with a diminishing role at larger aspect ratios.

A.4.6. Non-Neutral Plasma Studies

Studies in Pure Electron, Pure Ion and mixed species non-neutral plasmas: Numerical experiments have been performed to investigate the linear and nonlinear dynamics, and energetics of the ion resonance instability in cylindrically confined non-neutral plasma. The instability is excited on a set of parametrically different unstable equilibria of a cylindrical non-neutral cloud, composed of electrons partially neutralized by a much heavier ion species of single ionization. A particle-in-cell code has been developed and employed to carry out these simulations. The results obtained from the initial exponential growth phase of the instability in these numerical experiments are in agreement with the linearised analytical model of the ion resonance instability. As the simulations delve much further in time beyond the exponential growth phase, very interesting nonlinear phenomena of the ion resonance instability are revealed, such as a process of simultaneous wave breaking of the excited poloidal mode on the ion cloud and pinching of the poloidal perturbations on the electron cloud. This simultaneous nonlinear dynamics of the two components is associated with an energy transfer process from the electrons to the ions. At later stages there is heating induced cross-field transport of the heavier ions and tearing across the pinches on the electron cloud followed by an inverse cascade of the torn sections

A.4.7 Molecular Dynamics (MD) Simulations

Molecular dynamics study of laser-driven atomic cluster: Anharmonic resonance absorption of laser light is known to occur when the time-dependent frequency of a laser driven electron in the anharmonic electrostatic potential of a cluster becomes equal to the laser frequency. However, this mechanism is still a matter of debate. For this reason a three dimensional Molecular Dynamics (MD) code for studying the intense laser interaction with atomic nano-clusters has been developed. We have studied multi-particle dynamics of the ionized cluster with electrons (e) and ions (i) interacting (with e-e, e-i, i-i interactions) via Coulomb potential. The pure Coulomb potential being singular (when two particles are very close), it leads to unphysical energy gain. The Coulomb singularity is mitigated using a soft-core Coulomb potential. Extensive parametric studies have been performed and found that only certain values of this soft core parameter (depending upon the system size, system shape and inter-particle distance) lead to correct Mie-plasma frequency (Ω_{M}) and

correct plasma oscillation for a spherical system. The verification of Mie-plasma frequency with a spherical electron cloud oscillating in the spherical ion background is completed. Simultaneous studies on laser driven spherical cluster are being carried out using MD simulations.

Fusion Materials: Helium(He) produced by transmutation process inside structural material due to neutron irradiation plays a vital role in the degradation of material properties. We have carried out Molecular dynamics(MD) simulations to study the growth of He bubble in Iron-Chromium alloy. Simulations are carried out at two different temperatures, viz. 0.1 K and 800 K, upto He bubble radius of 2.5 nm. An equation for variation of volume of He bubbles with the number of He atoms is obtained at both the temperatures. Bubble pressure and potential energy variation is obtained with increasing bubble radius. Dislocations are also found to be emitted after the bubble reaches a critical radius of 0.39 nm at 800 K. Separate MD simulations of He with pre-created voids are also carried out to study the binding energies of He and Vacancy (V) to He m -V n cluster. Binding energies are found to be in the range of 1e5.5 eV.

Strongly coupled plasmas under gravitational field - a Molecular Dynamics study: Yukawa liquids in 2D when subject of external gravity and temperature gradient, is shown to be susceptible to Rayleigh-Benard convection. Unlike fluids whose constituent parts interact via short range, the Yukawa liquid shows remarkable dependence on the coupling strength. For example, whereas short range systems show a quadratic dependence of flow on the external temperature difference, Yukawa fluids show a novel linear dependence. This and several other properties have been addressed.

Molecular Dynamics study of Pair-Ion Plasmas: Existence of phase transition in strongly coupled pair-ion plasmas with soft core is investigated. Extensive Molecular Dynamics (MD) simulations are performed in the canonical ensemble, for such plasmas, at different temperatures, to analyze phase stability. Our studies show interesting phase co-existence between liquid-like and vapor-like phases. The different phases are identified by calculating the ensemble averaged density. This and the corresponding critical properties are calculated directly from MD simulation. The critical temperature of vapor-liquid coexistence is obtained, and the corresponding critical value of density is also estimated for different sizes of the soft core. We have used a novel method that allows the location of phase coexistence through a constant density simulation in which the temperature is changed in a single

time-step (quenching) in order to place the system in a thermodynamically and mechanically unstable state, resulting in spontaneous separation of two coexisting phases. The results obtained from this temperature quench MD method also show the coexistence of vapor-liquid phase in pair-ion plasmas. The critical exponents obtained directly from MD simulation are found to be in close agreement with the values predicted by a mean-field theory.

Study of Kolmogorov Flow In Strongly Coupled 2D Yukawa liquids: The transition from laminar to turbulent flows in liquids remains a problem of great interest despite decades of intensive research. Here, we report an atomistic study of this transition in a model Yukawa liquid using molecular dynamics simulations. Starting from an thermally equilibrated Yukawa liquid, for a given value of coupling parameter (defined as ratio of potential energy to kinetic energy per particle) and screening length a subsonic flow of magnitude U_0 is superposed and transition to an unstable regime is observed eventually leading to turbulent flow at sufficiently high Reynolds numbers. We have performed a parametric study for a range of Reynolds number R_y and found that the flow is neutrally stable for $R < R_c$, turbulent flow occurs for $R > R_c$ where R_c is the critical value of Reynolds number. Strong molecular shear heating is observed in all cases studied here. It is found that the coupling parameter decreases because of molecular shear heating on a time scale comparable to the instability time scale. Irrespective of the initial value of coupling parameter, the average heating rate is found to be sensitive to the ratio of equilibrium flow speed to the thermal speed. Our results reported here are expected to be generic and should apply to a wide variety of strongly coupled systems such as laboratory dusty plasma, molten salts, and charged colloidal systems.

--!!!--

CHAPTER B

ACTIVITIES ON OTHER CAMPUSES.

The following are activities done on other campuses and sometimes as sponsored projects, even though the work done is all under the mandate of the Institute. There are three other campuses at present as following :

B.1 Facilitation Center for Industrial Plasma Technology (FCIPT) Activities	46
B.2 ITER-India	49
B.3 Center of Plasma Physics - Institute for Plasma Research (CPP-IPR), Guwahati	57

B.1 Facilitation Center for Industrial Plasma Technologies (FCIPT) Activities

Completion of LPSC/ISRO Plasma Thruster Project: Electric propulsions are under investigation as a technology aiming to achieve thrust with high exhaust velocities in satellites, this results in a reduction in the amount of propellant required for a given space mission or application compared to other conventional propulsion methods. Hall Effect Thrusters already been installed and used in satellites due to their longer stability and reproducible thrust efficiency. Choice of anode liner material, magnetic field configuration and over all material properties of all components used in the thruster is crucial for the long stable operation of the thrusters. The propellant gas is basically ionised and ions are accelerated in electric propulsion to produce the thrust. Ceramic wall erosion due to ion induced sputtering is a life-limiting mechanism in Plasma Hall Effect thrusters used in satellites. Owing to relatively long lifetimes of thruster devices, effects of sputter erosion of thrusters ceramic and its deposition on sensitive equipment such as spacecraft solar cell are under investigation. Due to the lower sputtering yield Boron Nitride (BN) is used as ceramic material in plasma thrusters. The current research work was focused to investigate the erosion behaviour of the anode liner materials at various ion energies and angle of incidence, change in magnetic permeability of the material at elevated temperature, change in magnetic field topology of the magnetic circuit at elevated temperatures and surface flash over effects. For conducting such experiments first time in India, two in-situ facilities were developed at FCIPT/IPR equipped with ion sources, Quartz Crystal Microbalance (QCM) sensors, fast magnetic probes and data acquisition systems. Such studies were found to be very beneficial for ISRO's ongoing Plasma Thruster Program.

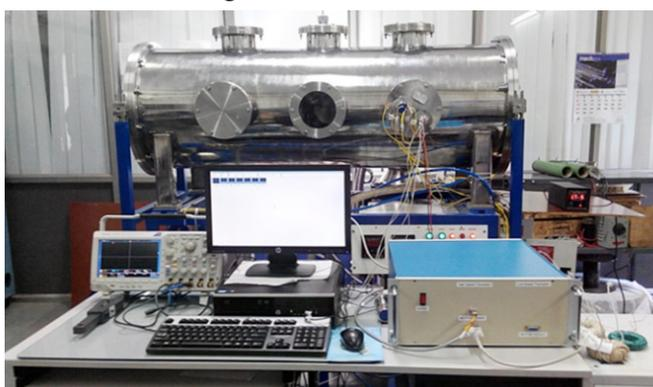

Figure B.1.1 Developed experimental setup for magnetic field mapping of the hall thruster

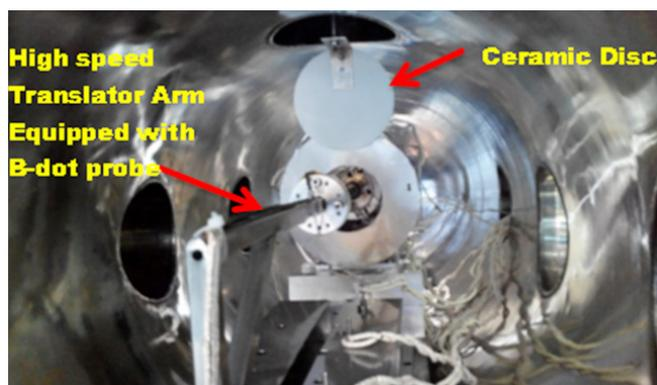

Figure B.1.2 High speed translator arrangement inside the vacuum chamber for magnetic field mapping

Completion of DST Nanomission Project : This was a part of three projects funded by DST Nanomission of India. The major objective of the project was to develop a method for growing highly ordered metal nanoparticles arrays and investigate their optical properties for plasmonics solar cell and sensing application. In this study low energy ions were used to produce self-organized nanosized ripple/dot like pattern on the surface, which later used as template to grow nanoparticles arrays as shown in Figure B.1.3. A spectroscopic ellip-

This activity facilitates a good running relation between the institute and the industries with the latest technological developments in plasma science and technology. In the past, many developed technologies have been commercialized through MOUs with many private industries

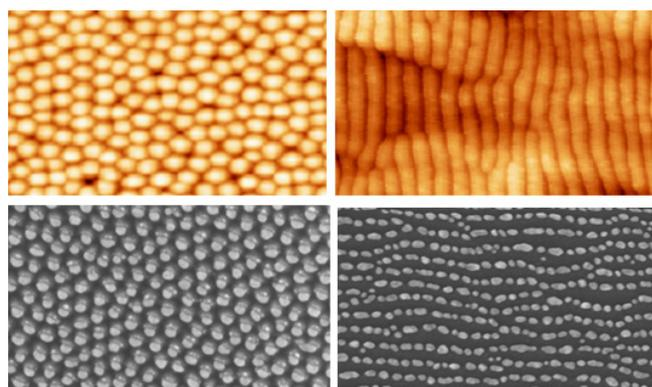

Figure B.1.3 AFM images of Nanodot and Nano ripple like structures

someter was procured under this project and used for optical characterisation of the silver nanoparticles. It was found that larger incident light field enhancement in silver nanoparticles arranged along the ripple help to see higher Surface Enhanced Raman Scattering SERS intensity compared to randomly distributed nanoparticles this is very encouraging results for sensing application. Hexagonally arranged silver nanoparticles grown on GaSb dots surface are highly light absorbing and can be used as top layer of plasmonic solar cell.

Completion of DST FAST Track Young Scientist Funding Scheme project: This project grant is awarded to a young scientist for conducting research. The objective of the project was to investigate pattern formation by means of plasma material interaction. A small experimental facility was developed to systematically vary the ion energy and flux of incident ions (figure B.1.4). Normal incidence of ions leads to self-organised dot patterns. It was observed that nanodots patterns grow bigger with ion energies and become smaller with increasing flux. The results were also compared with existing theories. The project is successfully completed.

Pulsed power source for Plasma Nitriding Applications technology has been successfully transferred to M/s Auto Controls, Mumbai: Power source is the most critical component of industrial plasma system. Its efficient and reliable operation is utmost necessary. Additionally for an industrial



Figure B.1.4 Developed Experimental facility for investigating pattern formation



Figure B.1.5 Image of the 25KW pulsed power source

system it is necessary that it should have the capability to run smoothly with minimum human intervention. Considering above facts FCIPT, IPR has designed an indigenous pulsed power source for industrial plasma nitriding system. The performance of this design has been critically validated in various in-house developed plasma nitriding systems. From the success of satisfactory performance of home grown technology and to meet the growing demand from various users it was realized to commercialize this technology. A Mumbai based industry “M/S Auto Controls” has shown deep interest to commercialize FCIPT, IPR technology for Indian entrepreneurs and business houses. FCIPT, IPR has successfully transferred this technology and the first product has been successfully commissioned and is in operation.

Surface hardening by radical nitriding process: Plasma nitriding process has been widely used by many industries to increase the life of the component by surface hardening. This low temperature, low pressure process not only increases the surface hardness but also the corrosion and wear resistance of the components. Hence this process can be used to improve the life of the agricultural components. But this process suffers from many limitations like high surface roughness, high capital cost and arcing during the process which may damage sharp edges. In order to overcome these limitations, a new

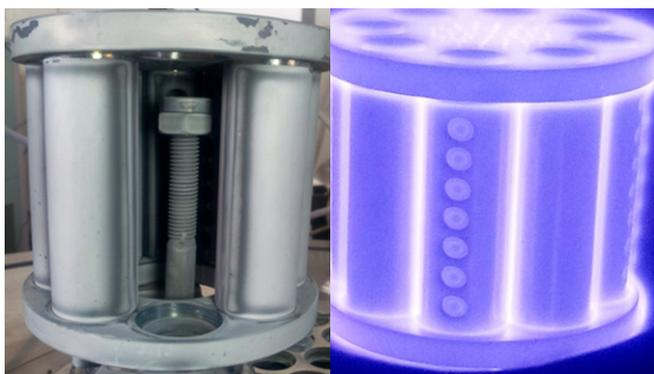

Figure B.1.6 a) Cathodic cage made of hollow tubes with sample in the center b) plasma formed on the cathodic cage.

advanced process called radical nitriding process has been developed in FCIPT with the assistance of Department of Science and Technology (DST), New Delhi. In this process, the material which is at floating potential is kept in a cathodic cage having many holes. Plasma of nitrogen/hydrogen gas mixture is formed on the cathodic cage. The active species are released from the plasma and get deposited on the material which then diffuses in to the material with time. As a result, the surface hardness of the material increases without leading to any significant change in surface roughness. This technology can help the industry for reducing the operating cost of process and retaining the sharpness of the cutting tools which is a very effective factor for the cutting industries. Radical Nitriding process has the following advantages compared to the conventional plasma Nitriding process. (i) Low power consumption, (ii) No ring formation near edge, (iii) No change in surface roughness, (iv) No hollow cathode effects in holes hence no overheating of individual parts, (v) No post treatment required for surface finish, (vi) Better control on white layer growth, (vii) No arc generation on finished surface and (viii) Environment friendly technology. In FCIPT, the cathodic cage was prepared by using hollow pipes to create a hollow cathode effect as shown in Fig. 8a. This enabled us to generate higher amount of radicals as well as helped in raising the temperature of the material to be treated. Radical nitriding of En 24 steel specimens were carried out in a cage made of hollow pipes as shown in Figure B.1.6. Several experiments were conducted by varying the distance between the specimen and the top plate of the cathodic cage.

Atmospheric Pressure Plasma Jet: A state of the art type atmospheric pressure plasma jet using dielectric barrier discharge has been developed. The plasma jet so formed is touchable by bare hands and can be used for bio-medical ap-



Figure B.1.7 Photo of single jet and multiple jet using atmospheric pressure plasma

plications. It also can be used for the surface modifications of larger areas. Much of this work has been done in house. Plasma apparatus is portable and operated by 24 V battery. It uses Argon gas. It operates at 2.5 W power and 25-55 kHz frequency. Possible applications include Blood Coagulation, Skin Disease treatment, Pesticides Removal, Seed Germination, Surface Activation of Polymers etc.

Low cost, user friendly Langmuir Probe for Plasma Diagnostics: Langmuir Probe is commonly used device for measurement of plasma parameters such as plasma density, electron temperature, plasma potential etc. FCIPT-IPR developed Langmuir Probe has programmable probe movement with a spatial resolution of less than 0.2 mm. Using this probe it is very easy to measure plasma parameters in different positions over 250 mm distance. Cost and efforts for development of plasma process can be saved by using such type of probe. This Plasma Diagnostic Probe can be useful to researchers who are working in the field of plasma processing.

Enthalpy Probe diagnostics for hot gas Measurements: For any application which involves use of hot gas / thermal plasma, a precise knowledge of temperature and enthalpy of the plume in two or three dimensions would be of great advantage because it can reduce design cycle times and fabrication costs. This diagnostic probe survives inside the hot gas / plasma plume and gives information about temperature, enthalpy and flow profiles. Enthalpy probe has been put up for commercialization. The probe can measure hot gas/plasma temperatures ~2000–10000 K and enthalpies ~MJ/kg. The design is novel; probe can be built in-house and is very cost-effective (approx. 10 times lower than global players). Local

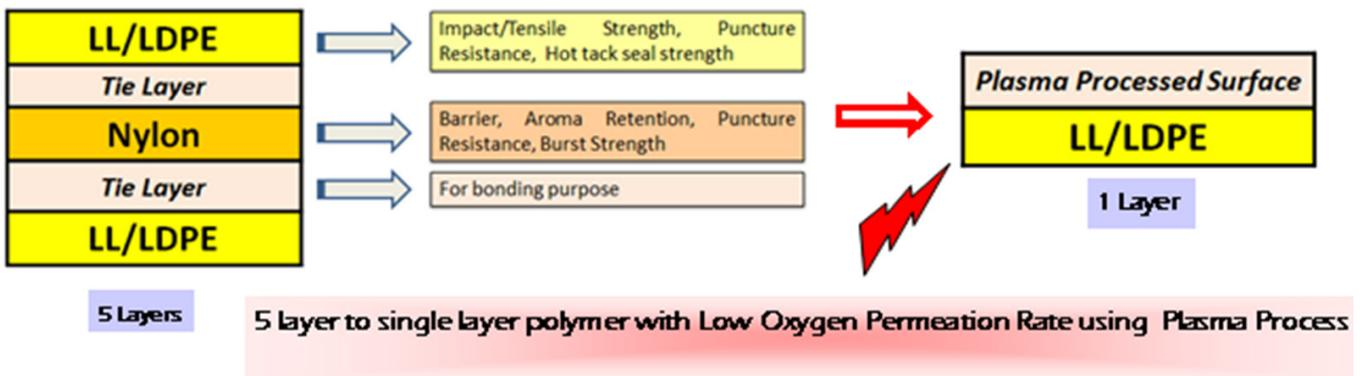

Figure B.1.9 Lay out of Oxygen Diffusion Barrier Coating for Packaging & Flexible Electronics

industry has evoked interest in buying the technology.

Oxygen Diffusion Barrier Coating for Packaging & Flexible Electronics: This type of coating on polymeric substrate is an essential part of modern packaging for protection of food and pharmaceutical products against outside environment. To overcome this problem, multi-layered (3-11 layers) film structures are being used for flexible pouch packaging. This adds the cost to packaging as well as disposal issues due to non-recyclability. A very thin coating ~ 100 nm thickness using plasma process has been developed which is able to prevent oxygen diffusion through polymer film. Oxygen Transmission Rate (OTR) value of virgin polymer (for this case polyethylene) is 3300 cc/m²/day and plasma processed polymer is less than 300 cc/m²/day which is almost 10 times lower. Research is still underway at FCIPT, IPR to further reduce OTR value.

Improving anti-felting properties of Wool by Atmospheric Pressure Plasma: Woollen products have a problem of shrinkage and pilling when exposed to aqueous medium, while laundering. This happens due to its inherent property of felting. Atmospheric pressure air plasma can modify the

physio-chemical surface properties of wool fiber, which can improve its anti-felting and dye-uptake characteristics.

B.2. ITER-India

In the past one year ITER-India made significant progress in the ITER project. During this period, the ITER-India project has entered into the manufacturing for few packages. The details of the activities completed under different packages/heads are given below.

ITER, an international project, is an experimental Fusion Reactor being constructed presently at Cadarache, in the South of France. ITER is a step towards future production of electricity from fusion energy

B.2.1 In-Wall Shielding (IWS)

The ITER Vacuum Vessel is a double wall structure, and IWS blocks shall be placed between outer and inner shells of Vacuum Vessel (VV) to stop escaping the neutrons and to reduce the toroidal magnetic field ripple. These shielding blocks are made of SS 304B4, SS 304B7, SS 430 and SS 316L (N)-IG and Fasteners (Bolts, Nuts, Spacers, Washers etc.) are made from XM-19 and Inconel-625. The manufacturing of IWS blocks is in progress at Avasarala Technologies Ltd. Bangalore. Rigorous Factory Acceptance Tests of (i) IWS blocks, (ii) Platforms, (iii) Brackets and (iv) two block assembly on support rib to check actual assembly issues were carried out. CMM and digital gauges were mainly used for all dimension inspection. Assembly of IWS blocks with different shapes



Figure B.1.10 (a) Untreated Merino wool fiber
(b) Plasma treated Merino wool fiber



Figure B.2.1 In-Wall Shielding factory acceptance tests

and high accuracy and vacuum packing for high cleanliness during transportation and storage were carried out. Large numbers of blocks and components have been manufactured and ready for assembly. Factory acceptance testing successfully conducted for several batches of IWS components. Support Ribs-Lower Bracket (SR-LB) assemblies, IWS blocks, platforms & studs shipped in several batches to Europe and Korea. Fabrication and factory acceptance tests of rest of components is in progress.

B.2.2 Cryostat

The ITER cryostat—the largest stainless steel high-vacuum pressure chamber ever built (16,000 m³)—provides the high vacuum, super-cool environment for the ITER vacuum vessel and the superconducting magnets. Nearly 30 metres each

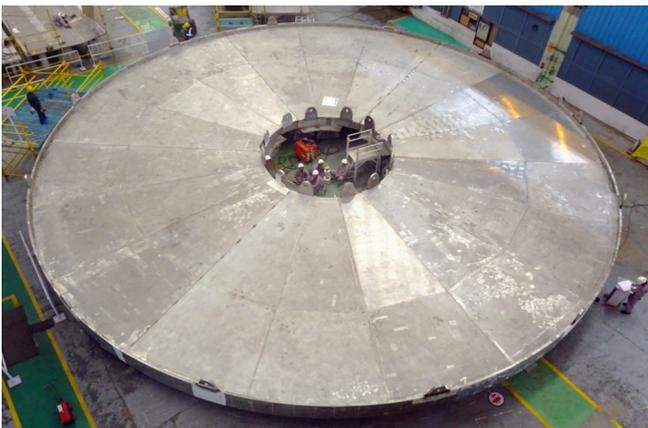

Figure B.2.3 Cryostat – Base Tier 1 Trial assembly at L&T Hazira



Figure B.2.2 In-Wall Shielding packed for transportation to French site

in width and height, the internal diameter of the cryostat has been determined by the size of the largest components its surrounds: the two largest poloidal field coils. Manufactured from stainless steel, the cryostat weighs 3,850 tonnes. Its base section—1,250 tonnes—will be the single largest load of ITER Tokamak assembly. The Cryostat will be manufactured in about 54 pieces that will form 4 main sections – Base, Lower Cylinder, Upper Cylinder & Top Lid. Fabrication of Tier-1 components of Cryostat Base section was completed, followed by successful inspection & trial assembly of all the 6 sectors at the manufacturer site. Each component/sector weighs nearly 50 tons, which were then packed and transported on special trailers to the Hazira port. These heavy pieces were then loaded on the ship and sent to France. Being a heavy exceptional load, the shipment traversed along the spe-



Figure B.2.4 Cryostat – Base Tier 1 components delivered at Cryostat workshop on ITER site



Figure B.2.5 First batch of piping delivered to ITER site, France

cial road “ITER itinerary” from Marseille port to ITER site, and the components reached the Cryostat workshop at ITER site during December 2015. The delivery of Tier-1 Base section components marks the arrival of the first ITER core machine components on site and also validates the achievement of the milestone ahead of schedule. Fabrication activities further progressed for Cryostat Base Section Tier-2 components and Lower Cylinder Tier-1 components at manufacturer site (L&T Heavy Engineering, Hazira

B.2.3 Cooling Water system

Certain ITER systems/components will be working on specific temperature during the operation, this temperature is needed to be kept in the required margins. Cooling water system is needed to take away heat from the various components/



Figure B.2.6 Sump Model Test of Cold Basin

systems and reject this in to the atmosphere. The first batch of Lot-1 piping fabrication was completed and the pipes were delivered to ITER site. Total 66 piping spools were dispatched from factories till March end. The Final Design Review of Lot-2 and Lot-3 piping was carried out. The Final Design Review of Heat Rejection System was also carried out. Final design activities for rest of piping & equipment progressed further. The Manufacturing Readiness Review (MRR) was conducted for piping fabrication & manually operated valves at the respective manufacturing locations. Sump Model Test was also carried out the pump manufacturer site.

B.2.4 Cryodistribution & Cryolines

The Cryogenic system is required at ITER for the operation of superconducting magnets and cryopumps. The Cryodistribution and Cryolines (CDCL) system, one of the Indian



Figure B.2.7 As installed Pre-series Cryo-Line PTCL-1) in ITER-India lab

contributions to ITER, have advanced to the next crucial level, where critical design outcomes have been experimentally validated with 1:1 scale performance evaluation at 4 K temperature level. CDCL team is proud to demonstrate the largest supercritical helium mass flow of 3.4 kg/s at 4.5 K by a single unit of centrifugal pump termed as cold circulator so far in the world. The Preliminary Design Review (PDR) of Lot Y1 and the Final Design Review of Lot Y2 cryolines have been completed. The manufacturing phase of 1st Pre-series Cryoline (PTCL-1) was completed, which was then transported; installed and necessary tests such as pressure tests, leak tests and radiography tests were performed at ITER-India Laboratory. The cold test of the PTCL-1 was also carried out which gave excellent results, and further experimental validation is ongoing. As a part of R&D, manufacturing and factory acceptance of the Test Auxiliary Cold Box (TACB) has been completed. Manufacturing and factory acceptance tests of Cold Circulator – 1 (CC-1) and Cold Circulator – 2 (CC-2) have been successfully completed fulfilling very rigorous dual regulatory requirements of Europe and Japan resulting CE certificate and KHK certificate simultaneously. Installation and commissioning of the TACB, two cold circulators as well as all the interfacing cryolines, vacuum pump, cooling water line, electrical and control system have been successfully completed at the test facility in JAEA-Naka, Japan. Final acceptance test of TACB has been completed demonstrating the required performance. The qualification test of two cold circulators has been successfully completed. ITER Cryodistribution (CD) system is one of the cooling buffer for the ITER project which will handle dynamic loads coming from application i.e. magnets, cryopump etc. There are seven cold boxes in this system. The contract was awarded to M/s. Linde Kryotechnik AG. Design kick off and preliminary design of Cryoplant termination cold box (CTCB)

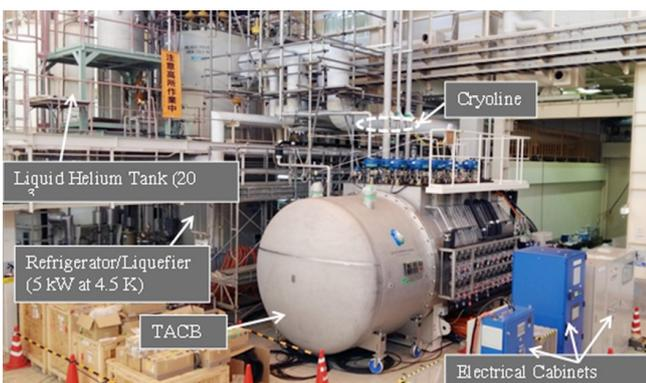

Figure B.2.8 Test Auxiliary Cold Box with two Cold Circulators installed at test facility, Japan

has been successfully completed. Preliminary design of Auxiliary Cold Boxes is now ongoing.

B.2.5 Ion Cyclotron Heating & Current Drive Sources

One of the important auxiliary heating and current drive methods for ITER plasma is by using radio frequency waves in the Ion Cyclotron Resonant Frequency (ICRF) range. Total 20 MW of ICRF power will be launched using 8 nos. of sources, each unit of having 2.5 MW/Continuous Wave (CW) capabilities, a Prototype unit is also included in this package for demonstrating the technology. India is responsible for supplying total 9 (1 Prototype and 8 series production) complete ICRF sources for ITER project. To identify the

India is a full partner in the ITER project, in which India would contribute in-kind like cryostat vessel, power supplies, cooling pipe-lines, some diagnostics systems etc which would be designed and manufactured according to international standards.

best high power vacuum tube (Diode/Tetrode) and other critical components for ITER application, an R&D program has been initiated. Two major contracts have been launched



Figure B.2.9 Tetrode based system under factory tests



Figure B.2.10 Tetrode based system under factory tests with dummy loads

with Thales Electron Devices, France for Diacrode technology and with Continental Electronics Corporation, USA for Tetrode technology, to finalize technical choices of vacuum tube technologies for final stage amplifier. 3MW test rig simulating mis-match load condition has been developed at ITER-India test facility. The Diacrode based system - Driver stage amplifier (HPA-2) and Final stage amplifier (HPA-3) have been assembled and installed successfully with other sub-systems like, low power RF section, Pre-driver amplifier (HPA1, based on solid state technology), auxiliary & high voltage power supplies, controls, air/water cooling and 3 MW Dummy Load via 12” Transmission-line system at ITER-India, IPR lab. HPA-2 was tested independently for static test as well as RF test for 130 kW/2000s at 35, 45, 55 & 65 MHz successfully on 50 Ohm dummy load. Integrated system has been tested successfully on matched condition for 1.5 MW at 35, 45, 55 and 65 MHz with +/-1 MHz bandwidth at 1dB point for more than 2000 s, creating an important database for international fusion community. For tetrode based system, factory tests were conducted at 750 kW/2000s & 2MW/short pulse (msec order) for 35 MHz & 65 MHz, after stabilization of the system against spurious and higher order mode oscillation. Bandwidth of the integrated system was tested at relatively lower power level (~ 120 kW) for the entire frequency range 35 – 65 MHz successfully

B.2.6 Electron Cyclotron Heating (ECH) system

The ITER EC H&CD system will be used for plasma heating and current drive applications including plasma start up. In this context, the Indian Domestic Agency (ITER-India) has a procurement package (EC Gyrotron Source Package) whose

main scope is to supply a set of two high power state of the art Gyrotron sources (170 GHz/1MW/3600s) including their auxiliary systems. The execution approach includes procurement of high power gyrotron tubes on functional specification basis and establishment of complete integrated performance. A Gyrotron Test Facility (IIGTF) with prototype auxiliary systems is being developed to establish the integrated Gyrotron system performance. Procurement activities related to Test Gyrotron & Corrugated Waveguide components for the Test Facility have progressed further and a review of current R&D status of potential suppliers has been completed. Regarding the test facility cooling infrastructure, based on the gyrotron supplier technical feedback, design optimization and analysis has been completed for cooling Header and distribution manifold. As an alternate solution to PSM based Gyrotron

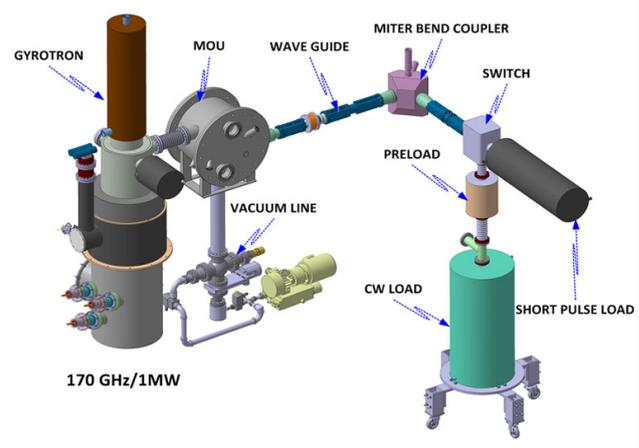

Figure B.2.11 Test Gyrotron & Waveguide test setup



Figure B.2.12 Industrial grade fault protection unit

Body Power Supply, an R&D activity using fast HV switches is ongoing to fulfil the fast modulation requirements. Under this activity, a fast H.V switch (35kV/100mA/1kHz modulation) has been procured. Proof of concept through the experimental setup using equivalent RC load is in advanced stage and promising initial test results have been achieved. Fast interlock system plays very important role in ensuring the safe operation of Gyrotron system. In this context, an Industrial grade centralized protection unit based on ITER-India design is currently being developed with the help of local industry. Under this development, component assembly & mechanical chassis assembly for Digital and analog modules has been completed and function testing has been carried out.

To avoid RF breakdown, the output waveguide line including the dummy load has to be evacuated for 1 MW Gyrotron operation. In this regard, an appropriate vacuum pumping system and various components have been procured, assembled and tested for required specifications.

B.2.7 Diagnostic Neutral Beam (DNB)

The Diagnostic Neutral Beam (DNB) (3 Seconds ON/20 Seconds OFF with 5 Hz modulation) in ITER is mandated to provide 100 kV, ~18-20 Amperes Hydrogen beam to support the Charge Exchange Recombination Spectroscopy (CXRS) for the measurement of Helium ash in the ITER machine. Indian Test Facility (INTF) vacuum vessel with the Diameter of 4.4m & Length 23m has been manufactured, commissioned and successfully tested in terms of its operational and functional requirements. The Ultimate vacuum of 10-5mbar is achieved and the deflection during evacuation is well within the tolerance. Leak tightness of the INTF Vessel is also achieved within the required limit, which is in the range 10^{-9} mbar.l/s (local) and 10^{-6} mbar.l/s (global). Contract has been awarded to M/s PVA Tepla for the supply of Beam Line Components. Under this contract, Neutralizer, Residual

Ion Dump & Calorimeter will be manufactured. Hardware integration & data cable routing is carried out for all of the diagnostics in design (CAD) model of INTF. Data acquisition, Control & electrical requirements for diagnostics are generated. An experiment to estimate unknown emissivity is carried out for Carbon Fiber Composite (CFC) & Stainless Steel material using heat source, thermocouple & FLIR IR camera. In Cavity Ring Down Spectroscopy (CRDS), vacuum cavity is setup & extensive hardware characterization is done. A concept based on plasma density dependent plasma impedance for characterizing the RF driver plasma using RF electrical parameters was developed earlier and the model is now updated with incorporation hybridization of physics & electrical concepts. 50 kV prototype High Voltage Bushing (HVB), a scale down configuration of DNB HVB is experimentally validated for its performance. Configurations of insulators, stress shields and other connecting flanges have been finalized and are fabricated. Manufacturing of 12 nos of Cryopump module LN2 section (Height - 3.2 m, Length - 0.54 m and Width - 0.3 m) is ongoing. Experimental preparation of Cryocooler based cryopump is going on for first phase experiment. Cryocooler has been procured and its testing in experimental vessel is in progress. Manufacturing and procurement of required components is in progress. Major technologies in the Beam Line Components (BLC) have been developed in collaboration with NFTDC. Under this program, CuCrZr raw material complying with all ITER chemical composition restrictions has been developed. Deep drilling over a length of 1.5 m in CuCrZr & OF Copper has been demonstrated and Electron Beam Welding of CuCrZr-Ni-SS 316L has been successfully done. 1 No. each of Scaled



Figure B.2.13 IN-TF Vacuum Vessel

and Full Scale Neutraliser Panel, 10 Nos. each of Residual Ion Dump (RID) Tube Elements and Heat Transfer Elements (HTE) have been manufactured.

B.2.8 ITER-India, Power Supply Group

The PS Group is responsible for design, development and supply of various Mega Watt (MW) High Voltage power supplies (HVPSs) for DNB, ICH&CD and ECH&CD system of ITER, France and for SPIDER experiments at Neutral Beam Test Facility, Padova, Italy. PS group is responsible to support R&D for the same systems at ITER-India lab. PS group is also engaged in developing Indian Industry for their participation in ITER and similar programme, including prototype efforts. Under manufacturing contract (for DNB-AGPS and SP-AGPS) to Electronics Corporation of India Ltd. (ECIL); major components have been manufactured at various facilities in India. 2.8MVA Oil filled multisecondary transformers to IEC standards were manufactured by M/s. T&R (I) Ltd. Ahmedabad. Challenging task include accommodating 150 terminals on the side wall by utilising specially cast epoxy boards that demonstrated high voltage withstand up to 140kVDC. 60kW SPS modules manufactured by M/s. AMTECH, Gandhinagar been tested for stringent requirements of EMC - Class A, severe environmental, vibration and shock test for oceanic transport. PXI based RT controller with FPGA was developed at ECIL, communicating over 700 channels in the field. Test setup developed by ITER-India replicating close to field interface was the highlight, paved the way for rigorous testing. Factory acceptance tests with participation of ITER Organization team have been conducted successfully. Manufactured components of SP-AGPS

have been organised for shipment to Test facility, Padua, Italy while DNB-AGPS received at ITER-India lab. As a part of R&D programme at ITER-India lab, Dual Output (27/18kV) High Voltage Power Supply is integrated and commissioned with ICRF source. Successful operations for 200, 500, 750 kW, 1500kW RF power @ 55MHz were conducted; with HVPS delivering regulated & stable electrical power up to 2800kW. High Voltage Transmission line that is a coaxial structure designed for >10MW power transport including RF power, Hydraulics and gas feed lines, was assembled at facility in Pune. Prototype section of 3.5m is delivered at ITER-India lab for HVDC testing. Extended length of 25m will support DNB experiments at ITER-India lab, similar solution will support ITER deliveries at later stage. Indigenous development of 40kW solid state High Frequency (1MHz) Power supply (HFPS) for Plasma formation in Ion Source, initiated with Industry and design being assessed.

B.2.9 ITER-India Diagnostics

First Preliminary Design Review (PDR-1) of Safety Important Class-1 (SIC-1) XRCS-Survey sight tube is carried out this year. The preliminary design & engineering, neutronics analysis of Survey spectrometer and XRCS Edge system are in progressive development. For XRCS systems, Plant I&C deliverables such as System Requirement Specifications, System Design Specifications, Operation procedures etc. have progressed for integrated PDR. Two I&C kits are received from ITER Organization, France and preparations are ongoing for their utilization in learning various functionalities and further development. For laboratory R&D experiments, most of the components have been ordered for con-



Figure B.2.14 2.8MVA Oil filled multisecondary transformers to IEC standards were manufactured by M/s. T&R (I) Ltd. Ahmedabad.



Figure B.2.15 Prototype section of 3.5m of High Voltage Transmission line

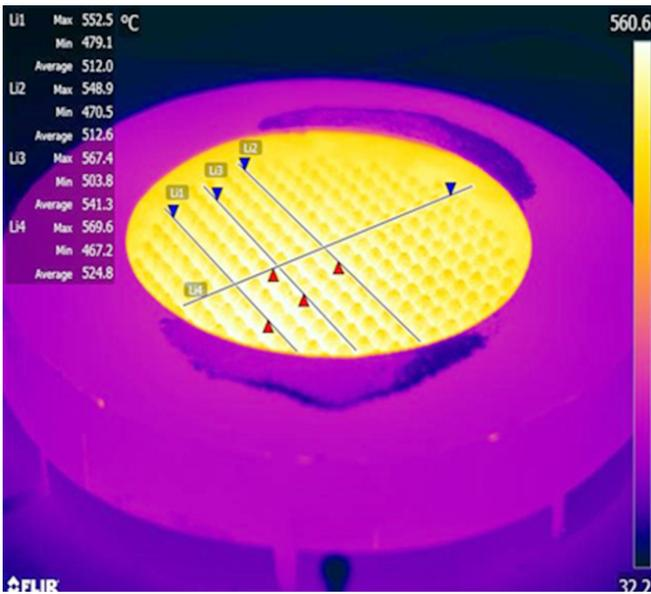

Figure B.2.16 IR image of the indigenously developed high temperature ($\sim 800\text{ }^{\circ}\text{C}$) blackbody source for calibration of 70 to 1000 GHz spectrometer.

ventional X-ray source and optical setup required for testing curved diffractors. The measurement of X-ray fluorescence from SS-316 target was done to establish the energy calibration of fast silicon drift detector. Engineering design and purchase of the components are under progress for constructing a single channel prototype crystal spectrometer and characterizing it with a broad band X-ray source based on XRF. For Electron Cyclotron Emission (ECE) diagnostic system, design, fabrication & assembly of components (vacuum enclosure, scanning engine, THz detector system etc.) for Polarizing Martin-Puplett type FTS are completed, and testing is under progress. Fabrication of prototype transmission line waveguide components is also progressing. Specifications have been developed for quasi optical power-splitter unit. Procurement activities for mm wave source (110-170 GHz) have been initiated. Software development for integration of prototype calibration source with CODAC is ongoing. For Upper Port 9, detail designing and integration of the diagnostics systems is in the preparation for PDR. System integration review for the detailing of the interfaces is scheduled. Technical activities like thermo-hydraulic analyses, Electromagnetic Analysis, assessment of cooling requirements for DSM, design of cooling channels, interface detailing, integration studies etc. are in progress. For Generic Upper Port Structure (GUPP), technical specifications are sent to nominated industries and common manufacturing schedule is being developed.

B.2.10 Activities of the Fusion Physics, Information Technology and IO-DA coordination group

Modelling of disruptions in DIII-D and CMOD tokamaks for studying dependence of halo current magnitude on halo parameters, e.g. halo temperature and width was continued as part of an ITPA activity of MHD working group W10. So far 3 experimental discharges in DIII-D and one CMOD discharge using the TSC code were modelled. Total 4 discharges in each machine will be modelled. Progress of this work was reported in ITPA meeting in October 2015 in Naples, Italy, as also through videoconferencing in the March IRPA meeting in NIFS, Japan. Participation in Science & Technology Advisory Committee (STAC) meetings was made. The IT group continued its efforts in continuous improvement in providing IT services to ITER-India personnel.

B.2.11 Activities common to all packages and project office

Monthly Package review meetings were conducted, budget estimates were prepared and payments were tracked. Regular schedule updates were made and reported at International organization. Ensured compliance to Quality Management System through various documents (Quality plan, Manufacturing & Inspection Plans, Procedures etc.) reviews. Adherence to modern international project management practices and also implementation of Intellectual Property Management (IP) activities through pre-screening of publications for IP and enforcing IP provisions in contracts with industry. Reporting of the developments to the public was also done through ITER Newline and ITER Annual Report.

Neutronics group activities: Development and Validation of ACTYS, an Activation Analysis code was done. ACTYS is a point activation depletion solver tailored for fusion applications. Sets of rigorous validations including validations against analytical results, fusion validations suggested by IAEA and against calculations of ITER systems are performed. First version of the code is planned to be released soon at national level. Neutronics, shielding and rad waste analysis for X-Ray Crystal Spectrometer planned to be placed at Equatorial Port Plug-11 of ITER is completed. This work is used to defend the neutronics part of said system at PDR.

B.2.12 Activities of ITER-India Design Office

Technical and quality support for the Fifty two Data Exchange Task (DET) between IO, DA and Suppliers. Technical (Design and Analysis) and training (CAD, FEA) support

to designers were provided. Nineteen designers certified for ENOVIA certification. Advanced CATIA training held as part of updating the professionals. Cryostat “Parametric Mathematical Model”(Developed by DO) is used to assess: Non Linear Buckling Analysis of Cryostat base Section, Design Assessment following the change in the manufacturing Tolerances. Load Specification of ECE component and the Preliminary design of waveguide support structure were developed. Design and analysis of splitter box, mounts, mirrors, and calibration source are ongoing. Simulation of High Heat Flux Components: Single phase and two phase simulation completed in ANSYS – CFX, Wall Nucleation and boiling model using ANSYS, validated using the experimental results. Influence of geometrical parameters studied and optimized for efficient heat transfer in the existing scenario. Design Officer supported the CAD activities as a PBSA for MPD and TBM systems. CAD Technical Support was provided which includes technical support to designer’s trouble shooting in daily CATIA/ENOVIA work, CAD methodology, and ITER specific CAD/PDM Tool processes. CAD quality checking, ENOVIA cad data structure management and checking, interface checking of the systems of different packages. Support and co-ordination in implementing the project changes via CCB and CAD Working group Workshop and Technical Meetings for Design Integration. Graphics, Videos of ITER-India packages were developed with details using 3DVIA Composer. Regular Participation in Configuration Control Board (CCB) and Technical Meetings was done in support of Change Management with respect to Design development and integration.

B.3. Centre of Plasma Physics - Institute for Plasma Research (CPP-IPR), Guwahati

B.3.1 Theoretical and Simulation Works

Effect of dust grains on plasma containing negative ions in an open magnetic field: The properties of a plasma containing surface produced negative ions and dust particles in presence of an axially varying magnetic field is studied. Both positive and negative ions are treated kinetically and the dust grains being massive are assumed to have some collective behavior using a fluid model. Constant finite temperature positive and negative ion sources are assumed throughout the plasma volume along with Boltzmann electrons. The particles are assumed to be guided by an open magnetic field with a field strength maximum at the centre and gradually decreasing towards the wall. Finally, the one dimensional Poisson

equation is derived analytically and then solved numerically. It has been found that the variation in negative ion concentration leads to modification in the potential profile and particle distributions. Because of the magnetic field structure and the sheath potential most of the negative ions are trapped in the pre-sheath region until it has sufficient thermal energy to overcome the electrostatic and mirror force. The addition of dust particles plays an important role in determining the sheath width of the plasma. Consequently, the sheath edge shifts towards left (bulk plasma) with increasing dust density. Another important observation is that on varying the dust surface potential and number of dust at the center, the dust density gradually increases with a maximum value at the wall. However, this increase in density is more profound when the dust surface potential becomes more negative. This analysis is useful in understanding the physics of a negative ion source which contains Cesium coated dust particles confined in a cusp magnetic field for surface production of negative ions.

The study of two stream instability for multi ion species in the plasma boundary: The study of streaming between two species of positive ions in a multi component plasma becomes much more interesting due to the varying behavior of the drift velocity of the two ion species while entering the sheath region. The instability is responsible an ion enhanced friction (IEF) force which drives the slow moving ion near the plasma boundary and drags it to the system sound speed. In our present work, we attempt to understand the effect of collision on two stream instability in a multi component plasma containing two species of positive ions and a single species of Boltzmann electron. The analysis is done through fluid approach.

Solution of Grad- Shafranov equation: This work attempts to solve the Grad Shafranov equation analytically. The Grad Shafranov equation is an equilibrium equation obtained by

CPP is at Nazirakhat, Sonapur about 32 km. from Guwahati, Assam. This institute was originally established under the Education (Higher) Department of Government of Assam. Now it has been merged with IPR with effect from 29 May 2009

the reduction of ideal MHD equation. It is an elliptic, two dimensional, nonlinear partial differential equation. It plays an important role in determining the equilibrium, stability and transport properties of toroidally axisymmetric fusion devices. The equation can be solved by assuming some suitable profile for current flux function and pressure flux function. In the present work, the magnetic flux surfaces are tried to design by resolving homogeneous and particular solution of the equation.

Particle trapping in the source-collector magnetized sheath:

The concept of source collector sheath has been formulated by Schwager and Birdsall in 1990. However, the same has not been extensively studied for a magnetized sheath. This work aims at understanding the particle behavior in the source collector magnetized sheath. It has been found that there are some particles which although starts towards the collector sheath, cannot reach the same and are reflected. These particles are trapped amidst the source and collector. The study is made through XOOPIC. The magnetic field is in oblique inclination to the surface. The phase space is studied for different angles of the magnetic field. The reflected particles are found to form a void in the phase space and the void size is found to depend highly on the magnetic field angle. In the presence of the two species of positive ions the two stream instability is also observed under such scenario. The instability has been found prominent for the low mass ratio of the ions, while for higher mass ratio the instability is damped out.

Propagation of Surface Wave along the surface separating plasmas of two different dielectrics:

During the last six months we have investigated an important problem namely ‘The propagation of plasma surface waves’ along the surface which separates plasmas of two different dielectrics. The problem to our knowledge has not been attempted earlier and therefore results which have been achieved are unique. We have considered a dividing line (at $x=0$) along which the plasma surface wave is considered to propagate. Electron-ion plasma is considered to occupy one half space along $x>0$, and dusty plasma occupies the second half space in the negative direction of x , i.e. for $x<0$. Fluid model is applied to define density distribution of plasma species for both the types of plasmas. The fluid equations in conjunction with Maxwell equations under suitable boundary conditions provided us the dispersion relation for plasma surface waves. The dispersion relation so obtained is solved computationally and wave dispersion curves are drawn for both high frequency and low frequency regime for various plasma parameters. Two distinct cases have been investigated viz: 1. When the $x=0$ plane

separates electron-ion plasma on one side and dusty plasma on the other side and 2. When surface wave is considered to flow along the dust void boundary. We have seen that our analytical model supports propagation and electromagnetic as well as electrostatic surface waves in both the cases mentioned above. Special emphasis is given to study electrostatic surface wave modes under variation in electron density on either side of the surface, the effect of thermal velocities of species, the effect of collision frequency etc. Importance of our findings over the results available in literature has been brought out vividly.

B.3.2. PIC modeling

Code for Negative ion extraction region: A 3-D PIC electrostatic code is under development for Extraction region of Negative ion sources. Debugging for the basic PIC modeling has been completed. Test runs with single component plasma (without negative ions) shows qualitative agreement with other works in this field, including the exhibition of meniscus formation by positive ions near the extraction grid.

Code for dust charging and related phenomena in Negative ion plasma:

The basic PIC module has been developed. With this basic module, as a test case, we have studied the effect of negative ion concentration on charging of dust grains in multicomponent plasma. Our results conform closely to other similar works in these fields.

Development of Semi-Automated system for Reactor Component Design and Optimization:

This is a new task initiated during the last quarter of 2015, in collaboration with Neutronics Section of IPR. The idea is to develop suite of codes/ code snippets that can be utilized in neutronics design and optimization of various components (like breeding and shield blankets) of future fusion reactor. The proposed system is named ‘‘Reactor Component Design and Optimization System’’ (RCDOS). Another component, named ‘‘CPP-IPR Fusion Reactor Material Database’’ (CIFRMD) has also been initiated. Coding for these suites are in progress.

B.3.3 Experimental Works

Commissioning of The CPP-IPR Magnetized Plasma Experiment for Plasma Surface Interaction (CIMPLE-PSI):

This was successfully commissioned recently, and started low power operations. This system shall recreate ITER Divertor like plasma with extreme heat (10 MW/m^2) and ($10^{24} \text{ m}^{-2}\text{s}^{-1}$) ion flux, to be used for plasma material interaction

experiments, a field of immense relevance to the contemporary controlled plasma fusion research. During full capacity, CIMPLE-PSI shall run at 600 kW power, about half of which is used for production of an axial magnetic field (upto 0.45 Tesla) by an water cooled copper electromagnet, for confinement of a helium/hydrogen plasma jet into a collimating beam, a configuration ideal for the PSI experiments. Designed in the line of Magnum-PSI (DIFFER, The Netherlands), the system uses a segmented arc as the source of plasma, and about 14,000 m³/h pumping speed to produce minimum neutral pressure near the plasma material interaction region, through the use of four numbers of huge roots vacuum pumps. During recent experiments, the diffused helium plasma was seen to get nicely collimated in presence of the axial magnetic field. The plasma density was measured in the order of 10²⁰ m⁻³, temperature about 1 eV, by optical emission spectroscopy techniques, using a McPherson 1.3-meter spectrometer. This facility shall be used to explore exposure of ITER grade tungsten under a helium plasma and hydrogen retention studies, in the immediate future.

Synthesis of ITER relevant tungsten dust particles and studies on their hydrogen absorption properties: Tungsten fine dust particles likely to be formed during operation of ITER like modern Tokamaks, were synthesized using the CPP-IPR High Heat Flux device and the plasma assisted nanoparticle reactor, whose hydrogen retention properties were explored, through Nuclear Reaction Analysis technique at National Centre for Compositional Characterization of Materials (NCCCM), Hyderabad. An important observation was non-equilibrium crystal morphologies were often formed, which demonstrated one of the highest retention of hydrogen so far (15.7%). They also possessed high specific surface area



Figure B.3.1 CPP-IPR Magnetized Plasma Experiment for Plasma Surface Interaction

(34.9 m²/g) or pronounced mesoporosity, one of the highest observed for tungsten.

Ion-ion plasma experiments in a Helicon source: The HeliPS experimental setup, which is continuing and shown in the adjacent photograph consists of a source glass chamber (60 cm long and 10 cm diameter) where Helicon plasma will be produced by wrapping a Helical antenna over it. There will be two stainless steel chambers: The expansion chamber and the extraction chamber. The expansion chamber is at present connected to the glass chamber and the Turbo Molecular Pump connected to the expansion chamber. Work is in progress. The HeliPS RF power supply's technical review and purchase process is in its final stage and the RFG will be delivered soon. The HeliPS antenna has a helical structure made up of copper strips. The ends of the antenna will be connected to the matching network's output cable's connecting terminals. The antenna's design and its antenna's fabrication is in progress. Two dc regulated power supplies (40 V, 600 A), to be used in the HeliPS solenoid coils for producing the magnetic field, were installed and tested upto 150 A and a magnetic field of 260 Gauss was obtained in a solenoid fabricated in the laboratory.



Figure B.3.2 HeliPS setup with glass chamber, expansion chamber, Vacuum pumping system and various gauges.

Study on surface processes in a negative ion source and measurement of negative ion parameters: In a hot cathode discharge or arc discharge, plasma, produced by electrons emitted from hot filaments, can be confined by multi-cusp magnetic fields. A magnetic field can reduce the flow of energetic primary electrons from the region where plasma is produced to the region where plasma diffuses. This magnetic field partition or magnetic filter can produce a region having electrons of energy in the range of 60 – 100 electron volts (eV) and a region having electrons of 1 eV or less. Negative ions generated in plasmas in such a configuration have traditionally been called “volume production sources”. In the volume of these sources, negative ions are generated in molecular gases due to dissociative attachment of low energy electrons to rovibrationally excited molecules. The project investigates the physical phenomena arising out of the use of magnetic filter field for production of negative ions. The following experiments are being done ; Study on the Electron Energy Distribution Function (EEDF) by varying discharge parameters, Effect of Secondary filament on diffused plasma parameters etc.

Inertial Electrostatic Confinement Fusion Based Neutron Source: An inertial electrostatic confinement fusion (IECF) based neutron source is currently under development at CPP-IPR. The objective is to develop portable neutron sources having linear and spherical geometry which will operate under continuous and repetitive burst mode and produce neutrons at the rate of 100 million to 10 billion per second. Such neutron source is expected to provide the scope to examine the damage occurring in electronic components and in fusion materials. Meanwhile a cylindrical IECF chamber has already been installed and plasma is being produced in it by both hot and cold cathode discharges. The plasma (mainly

deuterium) has been characterized by using planar Langmuir probe. In case of hot cathode discharge the plasma density is found to be highest nearby the filaments and falls away from the filaments. Electron temperature varies in between 2.52 to 3.25 eV. Temperature profile is found to be almost linear, although a slight density gradient is noticed. In cold cathode discharge mode shown in Fig 1a, a brighter axial glow at the centre of the grid is noticed that confirms the uniform ion flows for good core plasma convergence. Further the end on view illustrates the formation of ion channels that recirculates the main ion flow through central grid openings. This characteristic mode of operation in an IECF device is termed as “the star mode”. The mode of operation depends upon not only the input power but also filling gas pressure. At higher pressure (greater than 20 mTorr) “jet mode” of operation is marked.

B.3.4 Dusty Plasma Laboratory

Effect of magnetic field on dust charging and corresponding probe measurements: The effect of external magnetic field on the Langmuir probe measurements and dust charging are studied in low-pressure hydrogen plasma. The experiment is performed in a dusty plasma device where plasma is created by the hot cathode filament discharge technique. A strong strontium ferrite magnet is used inside the plasma, near the dust zone. The plasma parameters are measured at different distances from the magnet with the help of Langmuir probe system. It is observed that even at low magnetic field case, the electron collection by the probe deviates strongly from the actual value. The observations of electron energy probability functions show that at higher magnetic field, the Langmuir probe collects only the higher energy electrons compared to the low energy electrons. Both quasi-neutrality condition and

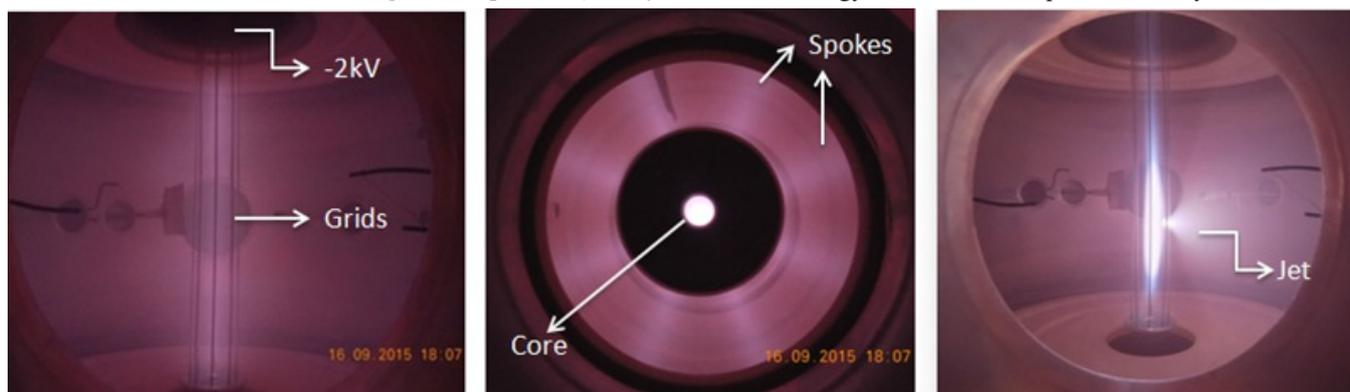

Figure B.3.3 (a) Side view of gas discharge indicating good convergence of ions, (b) bottom view of the plasma indicating Star Mode of operation, (c) side view of gas discharge indicating Jet Mode of operation.

capacitance model are used separately to calculate the charge accumulated on the dust grain. Introducing the reduction factor on quasi-neutrality condition, it is observed that the influence of magnetic field on dust charge is almost negligible for “low magnetic field” case. The dust charge results calculated from quasi-neutrality condition matches well with the experimentally observed dust current results, within the experimental error range. However, capacitance model deviates from the experimental results at higher magnetic field.

Study on plasma oscillations and instabilities in dust containing plasma: In this work, plasma oscillations as well as different instabilities are being studied in hydrogen plasma with flowing dust particles at different discharge conditions with/without external magnetic field. The frequency spectrum will be analyzed using the Fast Fourier transformation (FFT) technique of the signal. The experiment is going on and entire investigations on the plasma oscillations in presence of magnetic field and dust will be reported later on.

Inauguration of negative ions extraction laboratory: The negative hydrogen ions extraction laboratory was inaugurated recently. The experimental facility fabricated at IPR Mechanical Workshop is efficiently producing vacuum $\sim 10^{-7}$ mbar and plasma density $\sim 10^{16}$ m $^{-3}$. Recently, it was decided in the MB meeting that the present negative ion source should be converted to a floating one for achieving better beam current. Therefore, the experimental setup is currently being upgraded to a floating high voltage negative hydrogen ion source by making several modifications. The negative hydrogen ions produced by cesium coated tungsten dust will be extracted in this experimental facility.

B.3.5 Pulsed Plasma Accelerator Laboratory

Various activities were carried out to prepare the laboratory for the installation of a high voltage pulse power system (PPS). The initial works covered the specification generation, designing, indenting and testing of different parts/components. In the process we have tested two numbers dump resistor assembly in our pulse power testing facility. In the next phase, we have designed, fabricated and tested the first line of high current pulsed shaping inductor. These inductors were tested for its current carrying capacity, resultant inductance (for parallel connections), its effect on output pulse (pulse shape) etc. Initially five numbers of pulse-shaping inductors (each having inductance 105 μ H) were tested successfully by coupling it with the test circuit. Later on, the above inductors were replaced by using another two sets robust inductors

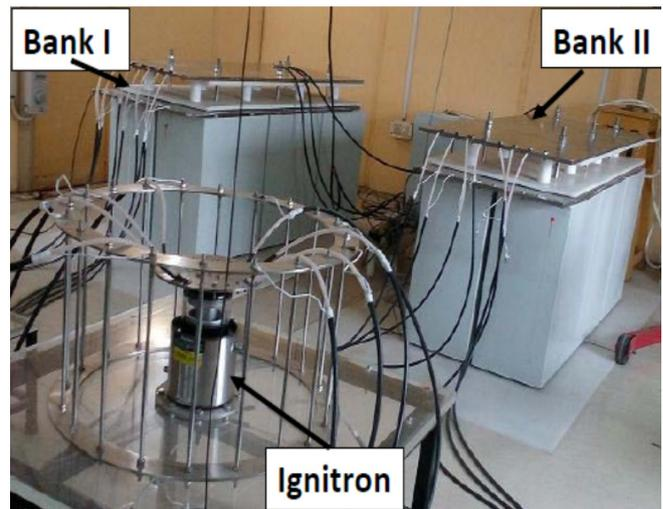

Figure B.3.4 Capacitor banks of Pulsed Power System

to get the required resultant inductance as 15 μ H. We have received 12 numbers of 180 μ F, 15 kV HV energy storage capacitors. The capacitors were clubbed separately in two assembly (bank) using parallel plate connections. The test firing of the capacitors bank were carried out from 1 kV to 15 kV and it was successfully discharged to get the desired peak discharged current of 50 kA and for a time period of 1.0 ms. For 200 KJ PPS, both the 100kJ banks were connected identically and fired through the damping resistor. In the same way starting from low voltage in steps, we discharged both the capacitor banks simultaneously to obtain output discharge current of 200 kJ PPS with peak current of 100 kA and 1 ms time period.

--!!!-

C. Academic Programme

C.1 Doctorate Programme	63
C.2 Summer School Programme.....	63

D. Technical Services

D.1 Computer Services	63
D.2 Library Services.....	64
D.3 Safety Training & Services	65

E. Publications and Presentations

E.1 Articles Publications	66
E.2 Internal Research and Technical Reports	81
E.3 Conference Presentations	89
E.4 Invited Talks Delivered by IPR Staff	128
E.5 Talks Delivered by Distinguished Visitors at IPR.....	133
E.6 Colloquia Presented at IPR	135
E.7 Scientific Meetings Hosted by IPR	137
E.8 MoU Signed	139



C. ACADEMIC PROGRAMMES

C.1 DOCTORATE PROGRAMME

In the Ph.D. programme conducted by the institute forty (40) research scholars have been enrolled at present. Out of them, twenty two (22) are working in theoretical and simulation projects while fourteen (14) are engaged in experimental projects. Four (4) new students have joined this programme during the year and are going through the course work. After successful completion of this course work, they will be enrolled for their Ph.D. works. Presently twelve (12) Post-Doctoral Fellows are engaged in their research work.

Ph.D. Thesis Submitted (during April 2015 - March 2016)

Studies on Quench Characteristics of Superconducting Magnets of SST-1

Aashoo N. Sharma

Homi Bhabha National Institute, 2015

Self-Organized Dust Rotation in an Unmagnetized DC Glow Discharge

Manjit Kaur

Homi Bhabha National Institute, 2015

Compact Pulsed Power Systems Using Liquid Dielectrics

G. Veda Prakash

Homi Bhabha National Institute, 2015

Global Gyrokinetic Study of Electromagnetic Microinstabilities in Tokamak Plasmas

Aditya Krishna Swamy

Homi Bhabha National Institute, 2015

Experimental Study of Plasma Oscillations in IMPED

Sayak Bose

Homi Bhabha National Institute, 2015

Study of Localized Potential Structure and Heating in Expanding Helicon Plasma

Soumen Ghosh

Homi Bhabha National Institute, 2015

Studies on Helium Cooled Plasma Facing Components for Tokamak Based Fusion Reactor Application

Sandeep Rimza

Homi Bhabha National Institute, 2016

Neutronics Benchmark Studies for the Tritium Breeding Blankets

Shrichand Jakhar

Homi Bhabha National Institute, 2016

C.2 SUMMER SCHOOL PROGRAMME (SSP)

Forty six (46) students participated in this programme, which aimed at providing an opportunity to (28) students from M.Sc. Physics and (18) students from Engineering discipline which include Mechanical, Electronics and instrumentation, Electrical, Chemical and Metallurgy, to interact actively with scientists of the institute and learn about Plasma Physics and related areas through a project and series of lectures. Besides the above-mentioned training programme, project works are routinely offered in Computer, Electronics and Electrical Engineering for regular students as a part of their academic requirements.

D. TECHNICAL SERVICES

D.1 Computer Services

During the period the following have been the achievements (i) BSNL Internet services up-gradation (50 to 100Mbps); (ii) Inter-Office leased lines up-gradation from 10Mbps to 50 Mbps helped in the centralization of IT services for remote offices from IPR; (iii) Campus Wi-Fi extension for new locations and hostel areas; (iv) Data Center public e-tender and work have started; (v) New desktops and other setup changes for all meeting rooms etc.; (vi) Procured star SSL certificate for domain ipr.res.in.; (vii) Implemented Software Modules like pay bill, reimbursement of claims (medical, travel advance, telephone bill etc.); (viii) Implementation of abstract submission and approval, document repository, workshop jobs submission, etc. (ix) Implementation of Air travel and local transport booking and approval, software installation request and approval; (x) Software for payment intimation to vendors etc were developed in-house and implemented.; (xi) Implementation of web based booking of Committee Room/Seminar Hall/VC Room booking through Zimbra Calendar.; (xii) New CCSERVER implemented on faster server. Now Users can also download software through http protocol. Virtual web hosting for internal server implemented on CCSERVER. New NTP server implemented; (xiii) Online recruitment for various IPR posts; (xiv) 35 TF High Performance Computing System was installed and made available

to users; (xv) Upgradation of IDL software in HPC Udbhav cluster; (xvi) Implemented professional Audio-Video recording system with live streaming at Seminar Hall for the talks, colloquiums, meetings or events. (xvii) Centralization of core software.

D.2 Library Services

Institute for Plasma Research (IPR) Library caters to the information needs of the specialized user community involved in research and development activities in the areas of Plasma Physics and Fusion Science and Technology. Library is well equipped with modern infrastructure and continues to serve its user community with focused collection and services. IPR library continues to subscribe to major databases such as SCOPUS, Online Archives of core journals such as Physics of Plasmas and Fusion Science and Technology, and many AIP and APS Journals including PROLA. Library added Online Historical Archives of Plasma Sources Science and Technology and Reports on Progress in Physics to its collection. Library has access to SCIENCE DIRECT through DAE Consortia.

All subscribed resources and other large collection of in-house electronic resources such as Research and Technical Reports, Reprint, Thesis, etc. are made accessible to the user community through library website (<http://www.ipr.res.in/library/>). Library continues to provide current awareness services by delivering current content, widely to plasma physicists at national level. Total 235 News items were displayed and archived as an Alerting Service.

During reporting period total of Rs. 24094551.00 budget was utilized. About 470 books and back volumes, 65 internal research reports, 40 technical reports, 45 research reports received from other research institutes, 143 reprints, 44 pamphlets and 24 software were added in to the library collection and subscribed to 106 periodicals. This year a total of 5 journal titles were migrated to only online and 2 new only online journals were added to e-collection.

Library continued to provide Article Delivery Services through Inter Library Loan (ILL) to the user community. 83.25% of the requests made by staff members were satisfied through Inter Library Loan (ILL) service. IPR Library provided documents to other institutes against their queries and 96.7% of the total need were satisfied. Total 36909 photocopies supplied to users. 4022 scanned copies were provided to the users.

Library orientation was given to newly joined members, Summer School Program Students, and Research Scholars. Information Literacy activities are regularly carried out for library users. SCOPUS Training was organized for library users.

Library carried out physical verification of documents during September 2015.

IPR Library celebrated Dr. A. P. J. Abdul Kalam's 87th Birth Anniversary by displaying his collection and a poster on the Life and works of Dr. Kalam on 15 October 2015. Library actively participated in other Institutional activities, such as Hindi Seminars/Meetings, Safety Week, etc. Library provided internship training programme to 3 MLISc students from Central University of Gujarat (CUG), Gandhinagar, and 2 MLISc students from Gujarat University, Ahmedabad during the year 2015-16.

D.4 Safety Training and Services

Safety Training Conducted in the Institute

Safety Training Conducted during 01.04.2015 to 31.03.2016

Sr. No.	Training Name	No. of persons attended	Date
1	Safety Induction Training	79	08 & 09.06.2015 20.07.2015 19.09.2015 19 & 20.11.2015 24.02.2016 02.03.2016
2	Practical Demonstration of Operating of Fire Equipments for Employees of IPR, FCIPT, IPR Extn.Bldg. & ITER-India	52	23.04.2015, 15.09.2015 & 23 & 28.10.2015
3	Practical Demonstration of Operating of Fire Equipments for Guest House Staff	10	25.08.2015
4	Practical Demonstration of Operating of Fire Equipments for Security Staff of IPR	35	28.04.2015
5	Practical Demonstration of Operating of Fire Equipments for Security Staff of IPR	46	21.01.2016
6	Practical Demonstration of Operating of Fire Equipments for Security Staff of FCIPT and IPR Extension Building	24	28.10.2015
7	Safety Awareness Program & Practical Demonstration of Operating of Fire Equipments for the Employees of CPP-IPR	24	22.07.2015
8	Practical Demonstration of Operating of Fire Equipments and demonstratin of fire alarm system for the security personnel of CPP-IPR	3	22.07.2015
9	First Aid Training for the Employees of IPR, FCIPT & ITER-India	26	22.12.2015
10	Training & Demonstration of AED Machine for the employees of FCIPT	16	17.06.2015
11	Training & Demonstration of AED Machine for the employees of IPR	23	04.02.2016
12	Safety Orientation Program for the employees of EPC & PMC of Laboratory & Auxiliary Building	33	18.11.2015 & 18.01.2016
13	Safety Orientation Program for the employees of contractor for the Aditya Upgradation Work	5	13.04.2015
14	Awareness Program on "Permit to Work System" for the employees of IPR	25	01.01.2016
15	Training Program on "Road Safety-Time for Action" for Contract Drivers	26	13.01.2016

--!!!--

E. PUBLICATION AND PRESENTATIONS

E.1 Articles Publications

E.1.1 Journal Articles

Advanced LIGO

J. AASI, A. KUMAR et.al.

Classical and Quantum Gravity, 32, 074001, 2015

Potential around a Dust Grain in Collisional Plasma
R. MOULICK, and K. S. GOSWAMI

Physics of Plasmas, 22, 043701, 2015

Probing Negative Ion Density and Temperature using a Resonance Hairpin Probe

N. SIRSE, S. K. KARKARI, and M. M. TURNER

Plasma Sources Science and Technology, 24, 022001, 2015

Collisionless Sheath Heating in Current-Driven Capacitively Coupled Plasma Discharges via Higher Order Sinusoidal Signals

S. SHARMA, S. K. MISHRA, P. K. KAW, A. DAS, N. SIRSE, and M. M. TURNER

Plasma Sources Science and Technology, 24, 025037, 2015

Cryogenic Acceptance Tests of SST-1 Superconducting Coils

A.N. SHARMA, U. PRASAD, K. DOSHI, P. VARMORA, Y. KHRISTI, D. PATEL, A. PANCHAL, S.J. JADEJA, V.L. TANNA, Z. KHAN, D. SHARMA, S. PRADHAN

IEEE Transactions on Applied Superconductivity, 25, 6924776, 2015

Data Acquisition and Control System for ECRH Systems on SST-1

JATINKUMAR J. PATEL, HARSHIDA C. PATEL, NATARAJABOOBATHI RAJANBABU, PRAGNESH DHORAJIYA, BRAJ KISHORE SHUKLA, PARESH J. PATEL, RATNESHWAR JHA, and DHIRAJ BORA

IEEE Transactions on Plasma Science, 43, 100-1105, 2015

Plasma-assisted Synthesis of Carbon Encapsulated Magnetic Nanoparticles with Controlled Sizes Correlated to Smooth Variation of Magnetic Properties

N. AOMOA, TRINAYAN SARMAH, U.P. DESHP and E, V. SATHE, A. BANERJEE, T. SHRIPATHI, V.R. REDDY, N.P. LALLA, A. GUPTA, RAJEEV GUPTA, DIVESH N. SRIVASTAVA, R.K. BORDOLOI, S. SARMA, A. SRINIVASAN, M. KAKATI

Carbon, 84, 24-37, 2015

Effect of Mass and Charge of Ionic Species on Spatio-Temporal Evolution of Transient Electric Field in CCP Discharges

S. SHARMA, S. K. MISHRA, P. K. KAW, M. M. TURNER, and S. K. KARKARI

Contributions to Plasma Physics, 55, 331-336, 2015

(IPR/RR-674/2014)

Quench Detection of SST-1 TF Coils by Helium Flow and Pressure Measurement

A. N. SHARMA, S. PRADHAN, U. PRASAD, P. VARMORA, Y. KHRISTI, K. DOSHI, and D. PATEL

Journal of Fusion Energy, 34, 331-338, 2015

Inverse Mirror Plasma Experimental Device (IMPED) - A Magnetized Linear Plasma Device for Wave Studies

SAYAK BOSE, P. K. CHATTOPADHYAY, J. GHOSH, S. SENGUPTA, Y. C. SAXENA, and R. PAL

Journal of Plasma Physics, 81, 00117, 2015

(IPR/RR-687/2014)

Thermal Expansion Characteristics of Fe-9Cr-0.12C-0.56Mn-0.24V-1.38W-0.06Ta (wt.%)

Reduced Activation Ferritic-Martensitic Steel
RAJU SUBRAMANIAN, HARAPRASANNA TRIPATHY, ARUN KUMAR RAI, RAJ NARAYAN HAJRA, SAROJA SAIBABA, TAMMANA JAYAKUMAR, ELLAPPAN RAJENDRA KUMAR

Journal of Nuclear Materials, 459, 150-158, 2015

Anomalous Collisional Absorption of Laser Pulses in Underdense Plasma at Low Temperature
M. KUNDU

Physical Review E, 91, 043102, 2015

Photoelectric Sheath Formation around Small Spherical Objects in Space

SHIKHA MISRA, S. K. MISHRA, and M. S. SODHA

Physics of Plasmas, 22, 043705, 2015

Application of Computational Fluid Dynamics for the Simulation of Cryogenic Molecular Sieve Bed Adsorber of Hydrogen Isotopes Recovery System for Indian LLCB-TBM

V. GAYATHRI DEVI, AMIT SIRCAR, and B. SARKAR

Fusion Science and Technology, 67, 567-570, 2015

Reduced Leakage Current and Improved Ferroelectricity in Magneto-Electric Composite Ceramics Prepared with Microwave Assisted Radiant Hybrid Sintering

SANJAY KUMAR UPADHYAY, V. RAGHAVENDRA REDDY, S. M. GUPTA, N. CHAUHAN, and AJAY GUPTA

AIP Advances, 5, 047135, 2015

Phase Transformation of Alumina Coating by Plasma Assisted Tempering of Aluminized P91 Steels

N.I. JAMNAPARAA, S. MUKHERJEE, S. KHANNA

Journal of Nuclear Materials, 464, 73-79, 2015 (IPR/RR-711/2015)

Epoxy-Novolac Interpenetrating Network Adhesive for Bonding of Plasma-Nitrided Titanium

S. AHMED, D. CHAKRABARTY, S. BHOWMIK, S. MUKHERJEE, and R. RANE.

Journal of Adhesion Science and Technology, 29, 1446, 2015

Observation of External Control and Formation of a Void in Cogenerated Dusty Plasma

SANJIB SARKAR, MALAY MONDAL, M.

BOSE and S. MUKHERJEE

Plasma Sources Science and Technology, 24, 035007, 2015

Localized electron heating and density peaking in downstream helicon plasma

SOUMEN GHOSH, K. K. BARADA, P. K. CHATTOPADHYAY, J. GHOSH and D. BORA

Plasma Sources Science and Technology, 24, 034011, 2015

(IPR/RR-721/2015)

An Experimental and Numerical Study of Flow and Heat Transfer in Helium Cooled Divertor Finger Mock-Up with Sectorial Extended Surface

SANDEEP RIMZA, SAMIR KHIRWADKAR, and KARUPPANNA VELUSAMY

Applied Thermal Engineering, 82, 390-402, 2015

Modelling and Analytic Studies of Sheared Flow Effects on Tearing Modes

D. CHANDRA, A. THYAGARAJA, A. SEN, C.J. HAM, T.C. HENDER, R.J. HASTIE, J.W. CONNOR, P. KAW, and J. MENDONCA

Nuclear Fusion, 55, 053016, 2015

Radial Resolution Evaluation for Oblique-View Electron Cyclotron Emission for ITER

P. V. SUBHASH, Y. GHAI, S. K. AMIT, A. M. BEGUM, and P. VASU

Fusion Science and Technology, 67, 705-717, 2015

Multipass Welding

SURESH AKELLA, and RAMESH KUMAR BUDDU

Yuva Engineers, 4, 4-8, 2015

Analytic Structure of a Drag-Driven Confined Dust Vortex Flow in Plasma

MODHUCHANDRA LAISHRAM, DEVENDRA SHARMA, and PREDHIMAN K. KAW

Physical Review E - Statistical, Nonlinear, and Soft Matter Physics, 91, 063110, 2015

An Experimental Set Up For Studying the Fusion Edge Plasma Facing Materials using TOF Mass Spectrometry

SUNIL KUMAR, PRAGYA BHATT, B.K. SINGH,
AJAI KUMAR, R. SHANKER

International Journal of Mass Spectrometry, 385, 32-41, 2015

Characterization of the LIGO Detectors during their Sixth Science Run

J. AASI, A. KUMAR, et.al

Classical and Quantum Gravity, 32, 115012, 2015

Thermal-Hydraulic Characteristics and Performance of 3D Wavy Channel Based Printed Circuit Heat Exchanger

HAMID HASSAN KHAN, ANEESH A. M, ATUL SHARMA, ATUL SRIVASTAVA, PARITOSH CHAUDHURI

Applied Thermal Engineering, 87, 519-528, 2015

Investigation of Shock-Shock Interaction and Mach Reflection in Laterally Colliding Laser-Blow-Off Plasmas

BHUPESH KUMAR, R. K. SINGH, SUDIP SENGUPTA, P. K. KAW and AJAI KUMAR

Physics of Plasmas, 22, 063505, 2015 (IPR/RR-724/2015)

Inverse Mirror Plasma Experimental Device - A New Magnetized Linear Plasma Device with Wide Operating Range

SAYAK BOSE, MANJIT KAUR, P. K. CHATTOPADHYAY, J. GHOSH and Y. C. SAXENA

Review of Scientific Instruments, 86, 063501, 2015

Novel Approaches for Mitigating Runaway Electrons and Plasma Disruptions in ADITYA Tokamak

R.L. TANNA, J. GHOSH, P.K. CHATTOPADHYAY, PRAVESH DHYANI, SHISHIR PUROHIT, S. JOISA, C.V.S. RAO, V.K. PANCHAL, D. RAJU, K.A. JADEJA, S.B. BHATT, C.N. GUPTA, CHHAYA CHAVDA, S.V. KULKARNI, B.K. SHUKLA, PRAVEENLAL E.V., JAYESH RAVAL, A. AMARDAS, P.K. ATREY, U. DHOBI, R. MANCHANDA, N. RAMAIYA, N. PATEL, M.B. CHOWDHURI, S.K. JHA, R. JHA, A. SEN, Y.C. SAXENA, D. BORA and ADITYA TEAM

Nuclear Fusion, 55, 063010, 2015

Flow Structure and Shear Generation in the 3D SOL of Circular Tokamak Plasma in Aditya
BIBHU PRASAD SAHOO, DEVENDRA SHARMA, RATNESHWAR JHA and YUHE FENG

Nuclear Fusion, 55, 063042, 2015

The ITPA Disruption Database

N.W. EIDIETIS, S.P. GERHARDT, R.S. GRANETZ, Y. KAWANO, M. LEHNEN, J.B. LISTER, G. PAUTASSO, V. RICCARDO, R.L. TANNA, A.J. THORNTON

Nuclear Fusion, 55, 063030, 2015

Studies on Mechanical Properties, Microstructure and Fracture Morphology Details of Laser Beam Welded Thick SS304L Plates for Fusion Reactor Applications

RAMESH KUMAR BUDDU, N. CHAUHAN, P.M. RAOLE, and HARSHAD NATU

Fusion Engineering and Design, 95, 34-43, 2015 (IPR/RR-689/2014)

Performance of Straight Tungsten Mono-Block Test Mock-Ups using New High Heat Flux Test Facility at IPR

YASHASHRI PATIL, S.S. KHIRWADKAR, S.M. BELSARE, RAJAMANNAR SWAMY, M.S. KHAN, S. TRIPATHI, K. BHOPE, D. KRISHNAN, P. MOKARIA, N. PATEL, I. ANTWALA, K. GALODIYA, M. MEHTA, T. PATEL

Fusion Engineering and Design, 95, 84-90, 2015

Tritium Breeding Mock-Up Experiments Containing Lithium Titanate Ceramic Pebbles and Lead Irradiated with DT Neutrons

SHRICHAND JAKHAR, M. ABHANGI, S. TIWARI, R. MAKWANA, V. CHAUDHARI, H.L. SWAMI, C. DANANI, C.V.S. RAO, T.K. BASU, D. MANDAL, SONALI BHADRE, R.V. KOLEKAR, P.J. REDDY, R. BHATTACHARYAY, P. CHAUDHURI

Fusion Engineering and Design, 95, 50-58, 2015 (IPR/RR-705/2014)

R&D on Divertor Plasma Facing Components at the Institute for Plasma Research

YASHASHRI PATIL, S. KHIRWADKAR, S. M. BELSARE, RAJAMANNAR SWAMY, M. S. KHAN, S. TRIPATHI, K. BHOPE

Nukleonika, 60, 285-288, 2015



An Atomic Magnetometer with Autonomous Frequency Stabilization and Large Dynamic Range
S. PRADHAN, S. MISHRA, R. BEHERA, POORNIMA and K. DASGUPTA

Review of Scientific Instruments, 86, 063104, 2015

ENG-Cladded Metamaterial-Loaded Helical Waveguide for Optoelectronics Applications

D.K. SHARMA, S.K. PATHAK

Journal of Electromagnetic Waves and Applications, 29, 2501- 2511, 2015

Ultrasonic Inspection of High Heat Flux (HHF) Tested Tungsten Monoblock Type Divertor Test Mock ups

KEDAR BHOPE, MAYUR MEHTA and S.S.KHIRWADKAR

E-Journal of Nondestructive Testing, 20, 2015

Fluid Simulation of Relativistic Electron Beam Driven Wakefield in a Cold Plasma

RATAN KUMAR BERA, SUDIP SENGUPTA and AMITA DAS

Physics of Plasmas, 22, 073109, 2015 (IPR/RR-725/2015)

Design, Development and Testing of Circular Waveguide Taper for Millimeter Wave Transmission Line

KRUPALI D. DONDA, RAVINDER KUMAR, and HITESHKUMAR B. PANDYA

International Journal of Microwaves Applications, 4, 22, 2015

Global Gas Balance and Influence of Atomic Hydrogen Irradiation on the Wall Inventory in Steady-State Operation of QUEST Tokamak

A. KUZMIN, H. ZUSHI, I. TAKAGI, S.K. SHARMA, A. RUSINOV, Y. INOUE, Y. HIROOKA, H. ZHOU, M. KOBAYASHI, M. SAKAMOTO, K. HANADA, N. YOSHIDA, K. NAKAMURA, A. FUJISAWA, K. MATSUOKA, H. IDEI, Y. NAGASHIMA, M. HASEGAWA, T. ONCHI, S. BANERJEE, K. MISHRA

Journal of Nuclear Materials, 463, 1087-1090, 2015

Identification of Best Fit Parameters of Void Nucleation and Growth Model using Particle

Swarm Technique

RITESH SUGANDHI, MANOJ WARRIER, SHASHANK CHATURVEDI

Applied Soft Computing Journal, 35, 113-122, 2015

Linear and Nonlinear Evolution of the Ion Resonance Instability in Cylindrical Traps: A Numerical Study

M. SENGUPTA and R. GANESH

Physics of Plasmas, 22, 072112, 2015 (IPR/RR-723/2015)

Collisionless Microtearing Modes in Hot Tokamaks: Effect of Trapped Electrons

ADITYAK. SWAMY, R. GANESH, S. BRUNNER, J. VACLAVIK and L. VILLARD

Physics of Plasmas, 22, 072512, 2015 (IPR/RR-726/2015)

Enhanced X-Ray Emission from Nano-Particle Doped Bacteria

M. KRISHNAMURTHY, M. KUNDU, KARTIK BANE, AMIT D. LAD, PRASHANT KUMAR SINGH, GOURAB CHATTERJEE, G. RAVINDRA KUMAR, and KRISHANU RAY

Optics Express, 23, 17909, 2015

Adaptive Directional Decomposition in Non Sub Sample Contourlet Transform Domain for Single Image Super Resolution

AMISHA J. SHAH, SURYAKANT B. GUPTA

Multimedia Tools and Applications, 1-25, 2015 (IPR/RR-715/2015)

Stability of an Elliptical Vortex in a Strongly Coupled Dusty Plasma

SAYANEE JANA, DEBABRATA BANERJEE and NIKHIL CHAKRABARTI

Physics of Plasmas, 22, 083704, 2015

Design, Development, and Results from a Charge-Collector Diagnostic for a Toroidal Electron Plasma Experiment

SAMBARANPAHARI, LAVKESHLACHHVANI, MANU BAJPAI, KARAN RATHOD, YOGESH YEOLE and P. K. CHATTOPADHYAY

Review of Scientific Instruments, 86, 083504, 2015

Rayleigh-Taylor Instability in Dusty Plasma Experiment

K. AVINASH and A. SEN

Physics of Plasmas, 22, 083707, 2015

Numerical Simulation of 14.1 MeV Neutron Irradiation Effects on Electrical Characteristics of PIPS Detector for Plasma X-Ray Tomography

P. VIGNESHWARARAJA, N. V. L. NARASIMHA MURTY, C. V. S RAO, and MITUL ABHANGI

IEEE Transactions on Nuclear Science, 62, 7156174, 2015

Self Organization of High β_p Plasma Equilibrium with an Inboard Poloidal Magnetic Field Null in QUEST

K. MISHRA, H. ZUSHI, H. IDEI, M. HASEGAWA, T. ONCHI, S. TASHIMA, S. BANERJEE, H. HANADA, H. TOGASHI, T. YAMAGUCHI, A. EJIRI, Y. TAKASE, K. NAKAMURA, A. FUJISAWA, Y. NAGASHIMA, A. KUZMIN

Nuclear Fusion, 55, 083009, 2015

Development of Impurity Seeding and Radiation Enhancement in the Helical Divertor of LHD

K. MUKAI, S. MASUZAKI, B.J. PETERSON, T. AKIYAMA, M. KOBAYASHI, C. SUZUKI, H. TANAKA, S.N. PANDYA, R. SANO, G. MOTOJIMA

Nuclear Fusion, 55, 083016, 2015

1D3V PIC Simulation of Propagation of Relativistic Electron Beam in an Inhomogeneous Plasma

CHANDRASEKHAR SHUKLA, AMITA DAS and KARTIK PATEL

Physica Scripta, 90, 085605, 2015

A Molecular Dynamics Study of Phase Transition in Strongly Coupled Pair-Ion Plasmas

SWATI BARUAH, R. GANESH and K. AVINASH

Physics of Plasmas, 22, 082116, 2015 (IPR/RR-719/2015)

Nonlinear Wave Excitations by Orbiting Charged Space Debris Objects

ABHIJIT SEN, SANAT TIWARI, SANJAY MISHRA, PREDHIMAN KAW

Advances in Space Research, 56, 429-435, 2015 (IPR/RR-698/2014)

Generation of Multiple Toroidal Dust Vortices by a Non-Monotonic Density Gradient in a Direct Current Glow Discharge Plasma

MANJIT KAUR, SAYAK BOSE, P. K. CHATTOPADHYAY, D. SHARMA, J. GHOSH, Y. C. SAXENA and EDWARD THOMAS JR.

Physics of Plasmas, 22, 093702, 2015

Confinement and Re-Expansion of Laser Induced Plasma in Transverse Magnetic Field: Dynamical Behaviour and Geometrical Aspect of Expanding Plume

NARAYAN BEHERA, R.K. SINGH, AJAI KUMAR

Physics Letters, Section A: General, Atomic and Solid State Physics, 379, 2215-2220, 2015 (IPR/RR-700/2014)

Progress in the Realization of the PRIMA Neutral Beam Test Facility

V. TOIGO, D. BOILSON, T. BONICELLI, R. PIOVAN, M. HANADA, A. CHAKRABORTY, G. AGARICI, V. ANTONI, U. BARUAH, M. BIGI, G. CHITARIN, S. DAL BELLO, H. DECAMPS, J. GRACEFFA, M. KASHIWAGI, R. HEMSWORTH, A. LUCHETTA, D. MARCUZZI, A. MASIELLO, F. PAOLUCCI, R. PASQUALOTTO, H. PATEL, N. POMARO, C. ROTTI, G. SERIANNI, M. SIMON, M. SINGH, N.P. SINGH, L. SVENSSON, H. TOBARI, K. WATANABE, P. ZACCARIA, P. AGOSTINETTI, M. AGOSTINI, R. ANDREANI, D. APRILE, M. BANDYOPADHYAY, M. BARBISAN, M. BATTISTELLA, P. BETTINI, P. BLATCHFORD, M. BOLDRIN, F. BONOMO, E. BRAGULAT, M. BROMBIN, M. CAVENAGO, B. CHUILON, A. CONIGLIO, G. CROCI, M. DALLA PALMA, M. D'ARIENZO, R. DAVE, H. P. L DE ESCH, A. DE LORENZI, M. DE MURI, R. DELOGU, H. DHOLA, U. FANTZ, F. FELLIN, L. FELLIN, A. FERRO, A. FIORENTIN, N. FONNESU, P. FRANZEN, M. FROSCHE, E. GAIO, G. GAMBETTA, G. GOMEZ, F. GNESOTTO, G. GORINI, L. GRANDO, V. GUPTA, D. GUTIERREZ, S. HANKE, C. HARDIE, B. HEINEMANN, A. KOJIMA, W. KRAUS, T. MAESHIMA, A. MAISTRELLO, G. MANDUCHI, N. MARCONATO, G. MICO, J. F. MORENO, M. MORESCO, A. MURARO, V. MUVVALA, R. NOCENTINI, E. OCELLO,

S. OCHOA, D. PARMAR, A. PATEL, M. PAVEI, S. PERUZZO, N. PILAN, V. PILARD, M. RECCHIA, R. RIEDL, A. RIZZOLO, G. ROOPESH, G. ROSTAGNI, S. SANDRI, E. SARTORI, P. SONATO, A. SOTTOCORNOLA, S. SPAGNOLO, M. SPOLAORE, C. TALIERCIO, M. TARDOCCHI, A. THAKKAR, N. UMEDA, M. VALENTE, P. VELTRI, A. YADAV, H. YAMANAKA, A. ZAMENGO, B. ZANIOL, L. ZANOTTO and M. ZAUPA
Nuclear Fusion, 55, 083025, 2015

Plasma Nitriding on Titanium Surface For Adhesion Promotion
 S. AHMED, D. CHAKRABARTY, S. BHOWMIK, S. MUKHERJEE, R. RANE
Surface Engineering, 31, 616- 622, 2015

Observation of the Rayleigh-Benard Convection Cells in Strongly Coupled Yukawa Liquids
 HARISH CHARAN and RAJARAMAN GANESH
Physics of Plasmas, 22, 083702, 2015
(IPR/RR-708/2014)

Magnesium-Diboride-based Prototype ELM Coil Fabrication, DC Characterization, and AC Transport-Current-Induced Loss Estimation: A Feasibility Study
 A. KUNDU, S. PRADHAN, A. PANCHAL, A. BANO, P. RAJ, S. K. DAS, N. KUMAR
IEEE Transactions on Applied Superconductivity, 25, 7115069, 2015

Technology and Engineering Aspects of High Power Pulsed Single Longitudinal Mode Dye Lasers
 V. S. RAWAT, JAYA MUKHERJEE, L. M. GANTAYET
Progress in Quantum Electronics, 43, 31-77, 2015

Thermionic and Photoelectric Emission of Electrons from Positively Charged Particles in a Plasma with Debye Shielding
 MAHENDRA SINGH SODHA, RASHMI MISHRA, SWETA SRIVASTAVA and SANJAY KUMAR MISHRA
Physics of Plasmas, 22, 093704, 2015

Sustenance of Inhomogeneous Electron Temperature in a Magnetized Plasma Column
 S. K. KARKARI, S. K. MISHRA and P. K. KAW
Physics of Plasmas, 22, 092107, 2015

Hot Dip Aluminumizing of 9Cr-1Mo Steels and their Heat Treatment
 JALPA PATEL, PRASHANT HUILGOL, NIRAV JAMNAPARA, K. UDAYA BHAT
Materials Science Forum, 830-831, 143-146, 2015

An Update of Spacecraft Charging Research in India: Spacecraft Plasma Interaction Experiments-SPIX-II
 SURYAKANT B. GUPTA, KEENA R. KALARIA, NARESH P. VAGHELA, RASHMI S. JOSHI, SUBROTO MUKHERJEE, SURESH E. PUTHANVEETIL, MUTHUSAMY SANKARAN, and RANGANATH S. EKKUNDI
IEEE Transactions on Plasma Science, 43, 3041, 2015

Diagnostic of Neutralization Current for Arcs on Satellite Solar Panel Coupons
 RASHMI S. JOSHI and SURYAKANT B. GUPTA
IEEE Transactions on Plasma Science, 43, 3000, 2015
(IPR/RR-736/2015)

Emission Analysis of a Laser-Produced Barium Plasma Plume
 R. K. SINGH, H. C. JOSHI, and AJAI KUMAR
Applied Optics, Vol.54, 7673-7678, 2015

Design of Vacuum Vessel for Indian Test Facility (INTF) for 100 KeV Neutral Beams
 JAYDEEP JOSHI, ASHISH YADAV, ROOPESH GANGADHARAN, RAMBILAS PRASAD, SHINO ULAHANNAN, CHANDRAMOULI ROTTI, MAINAK BANDYOPADHYAY, ARUN CHAKRABORTY
Fusion Engineering and Design, 96-97, 488-492, 2015

Design of Data Acquisition and Control System for Indian Test Facility of Diagnostics Neutral Beam
 JIGNESH SONI, HIMANSHU TYAGI, RATNAKAR YADAV, CHANDRAMOULI

ROTTI, MAINAK BANDYOPADHYAY, GOURAB BANSAL, AGRAJIT GAHLUAT, DASS SUDHIR, JAYDEEP JOSHI, RAMBILAS PRASAD, KAUSHAL PANDYA, SEJAL SHAH, DEEPAK PARMAR, ARUN CHAKRABORTY
Fusion Engineering and Design, 96-97, 961-965, 2015

Maturity Assessment of ITER Diagnostics Plant Instrumentation and Control Design
 STEFAN SIMROCK, LANA ABADIE, ROBIN BARNESLEY, BERTRAND BAUVIR, LUCIANO BERTALOT, PETRI MAKIJARVI, MIKYUNG PARK, ROGER REICHEL, DENIS STEPANOV, GEORGE VAYAKIS, ANDERS WALLANDER, MICHAEL WALSH, AXEL WINTER, IZURU YONEKAWA, ZHAO LI, TSUYOSHI YAMAMOTO, SANJEEV VARSHNEY, JIHYUN CHOI, EKATERINA MIRONOV, ANDRE NETO, BILL DEVAN, PRABHAKANT PATIL, MANOJKUMAR ANNIGERI, DARIUSZ MAKOWSKI, ALEKSANDER MIELCZAREK, PIOTR PEREK, MARIUSZ ORLIKOWSKI, MATJAZ BERČIĆ, KLEMENZAGAR, VINCENT MARTIN
Fusion Engineering and Design, Volumes 96-97, 952-956, 2015

Status of R&D Activity for ITER ICRF Power Source System
 APARAJITA MUKHERJEE, RAJESH TRIVEDI, RAGHURAJ SINGH, KUMAR RAJNISH, HARSHA MACHCHHAR, P. AJESH, GAJENDRA SUTHAR, DIPAL SONI, MANOJ PATEL, KARTIK MOHAN, J.V.S. HARI, ROHIT ANAND, SRIPRAKASH VERMA, ROHIT AGARWAL, AKHIL JHA, FABIENNE KAZARIAN, BERTRAND BEAUMONT
Fusion Engineering and Design, 96-97, 542-546, 2015

Progress in the ITER Electron Cyclotron Heating and Current Drive System Design
 T. OMORI, F. ALBAJA, T. BONICELLI, G. CARANNANTE, M. CAVINATO, F. CISMONTI, C. DARBOS, G. DENISOV, D. FARINA, M. GAGLIARDI, F. GANDINI, T. GASSMANN, T. GOODMAN, G. HANSON, M.A. HENDERSON, K. KAJIWARA, K. MCELHANEY, R. NOUSIAINEN, Y. ODA, A. OUSTINOV, D.

PARMAR, V.L. POPOV, D. PUROHIT, S.L. RAO, D. RASMUSSEN, V. RATHOD, D.M.S. RONDEN, G. SAIBENE, K. SAKAMOTO, F. SARTORI, T. SCHERER, N.P. SINGH, D. STRAUSS, K.TAKAHASHI
Fusion Engineering and Design, 96-97, 547-552, 2015

First Experiments in SST-1
 S. PRADHAN, Z. KHAN, V.L. TANNA, A.N. SHARMA, K.J. DOSHI, U. PRASAD, H. MASAND, AVEG KUMAR, K.B. PATEL, M.K. BHANDARKAR, J.R. DHONGDE, B.K. SHUKLAIA. MANSURI, A. VARADARAJULU, Y.S. KRISTI, P. BISWAS, C.N. GUPTA, D.K. SHARMA, D.C. RAVAL, R. SRINIVASAN, S.P. PANDYA, P.K. ATREY, P.K. SHARMA, P.J. PATEL, H.S. PATEL, P. SANTRA, T.J. PAREKH, K.R. DHANANI, Y. PARAVASTU, F.S. PATHAN, P.K. CHAUHAN, M.S. KHAN, J.K. TANK, P.N. PANCHAL, R.N. PANCHAL, R.J. PATEL, S. GEORGE, P.SEMWAL, P. GUPTA, G.I. MAHESURIYA, D.P. SONARA, S.P. JAYSWAL, M. SHARMA, J.C. PATEL, P.P. VARMORA, D.J. PATEL, G.L.N. SRIKANTH, D.R. CHRISTIAN, A GARG, N. BAIRAGI, G.R. BABU, A.G. PANCHAL, M.M. VORA, A.K. SINGH, R. SHARMA, D. RAJU, S.V. KULKARNI, M. KUMAR, R. MANCHANDA, S. JOISA, K. TAHILIANI, S.K. PATHAK, K.M. PATEL, H.D. NIMAVAT, P.R. SHAH, H.H. CHUDASMA, T.Y. RAVAL, A.L. SHARMA, A. OJHA, B.R. PARGHI, M. BANAUDHA, A.R. MAKWANAM, M. CHOWDHURI, N. RAMAIYA, A. KUMAR, J.V. RAVAL, S. GUPTA, S. PUROHIT, R. KAUR, A.N. ADHIYA, R. JHA, S. KUMAR, U.C. NAGORA, V. SIJU, J. THOMAS, V.R. CHAUDHARI, K.G. PATEL, K.K. AMBULKAR, S. DALAKOTI, C.G. VIRANI, P.R. PARMAR, A.L. THAKUR, A. DAS, D. BORA and THE SST-1 TEAM

Nuclear Fusion, 55, 104009, 2015

Kolmogorov Flow in Two Dimensional Strongly Coupled Yukawa Liquid: A Molecular Dynamics Study
 A. GUPTA, R. GANESH, and A. JOY
Physics of Plasmas, 22, 103706, 2015 (IPR/RR-656/2014)

Coaxial Propagation of Laguerre-Gaussian (LG) and Gaussian Beams in a Plasma and Gaussian Beams in a Plasma

S .MISRA, S.K MISHRA, P.BRIJESH
Laser and Particle Beams, 33, 123-133, 2015

25th IAEA Fusion Energy Conference: Summary of Sessions EX/S, EX/W and ICC

A. SEN
Nuclear Fusion, 55, 104024, 2015

Optical Characterisation of Plasmonic Nanostructures on Planar Substrates using Second-Harmonic Generation

LINA PERSECHINI, RUGGERO VERRE, CHRISTOPHER M. SMITH, KARSTEN FLEISCHER, IGOR V. SHVETS, MUKESH RANJAN, STEFAN FACSKO, and JOHN F. MCGILP

Optics Express, 23, 26486-26498, 2015

From The Conceptual Design to the First Simulation of the New WEST Plasma Control System

R. NOUAILLETAS, N. RAVENEL, J. SIGNORET, W. TREUTTERER, A. SPRING, M. LEWERENTZ, C.J. RAPSON, H. MASAND, J. DHONGDE, P. MOREAU, B. GUILLERMINET, S. BREMOND, L. ALLEGRETTI, G. RAUPP, A. WERNER, F. SAINT LAURENT, E. NARDON, M. BHANDARKAR

Fusion Engineering and Design, 96-97, 680-684, 2015

Operation of SST-1 TF Power Supply during SST-1 Campaigns

DINESH KUMAR SHARMA, MURTUZA M. VORA, AMIT OJHA, AKHILESH KUMAR SINGH, CHIRAG BHAVSAR.

Fusion Engineering and Design, 98-99, 1153-1157, 2015

Enhanced Integrators for WEST Magnetic Diagnostics

PASCAL SPUIG, PRAVEENA KUMARI, MICHEL MOREAU, PHILIPPE MOREAU, ALAIN LE-LUYER, PHILIPPE MALARD

Fusion Engineering and Design, 96-97, 966-969, 2015

Investigation of X-Ray Spectral Response of D-T Fusion Produced Neutron Irradiated PIPS Detectors for Plasma X-Ray Diagnostics

P.V. RAJA, N.V.L.N. MURTY, C.V.S. RAO, and M. ABHANGI

Journal of Instrumentation, 10, P10018, 2015

New Design Aspects of Cooling Scheme for SST-1 Plasma Facing Components

YUVAKIRAN PARAVASTU, ZIAUDDIN KHAN, SUBRATA PRADHAN

Fusion Engineering and Design, 98-99, 1375-1379, 2015

Development of Laser Beam Welding for the Lip Seal Configuration

ASHISH YADAV , JAYDEEP JOSHI, DHANANJAY KUMAR SINGH, HARSHAD NATU, CHANDRAMOULI ROTTI, MAINAK BANDYOPADHYAY, ARUN CHAKRABORTY

Fusion Engineering and Design, 96-97, 192-198, 2015

Second-Harmonic Ion Cyclotron Resonance Heating Scenarios of Aditya Tokamak Plasma

ASIM KUMAR CHATTOPADHYAY, S V KULKARNI, R SRINIVASAN, ADITYA TEAM

Pramana - Journal of Physics, 85, 713-721, 2015

High-Resolution Spectroscopy Diagnostics for Measuring Impurity Ion Temperature and Velocity on the COMPASS Tokamak

VLADIMIR WEINZETTL, GAURAV SHUKLA, JOYDEEP GHOSH, RADEK MELICH, RADOMIR PANEK, MATEJ TOMES, MARTIN IMRISEK, DIANA NAYDENKOVA, JOSEF VARJU, TIAGO PEREIRA, RUI GOMES, IVANA ABRAMOVIC, ROGER JASPERS, MICHAEL PISARIK, TOMAS ODSTRCIL, GUIDO VAN OOST

Fusion Engineering and Design, 96-97, 1006-1011, 2015

Development of Highly Hard and Corrosion Resistant A286 Stainless Steel through Plasma Nitrocarburizing Process

J. ALPHONSA, V.S. RAJA, S. MUKHERJEE
Surface and Coatings Technology, 280, 268-276, 2015

Calibration of Acoustic Emission System for Materials Characterization

SV RANGANAYAKULU, BS GOUD, PV SASTRY, BR KUMAR

Universal Journal of Materials Science, 3, 62-69, 2015

Effect of Magnetic Field on Dust Charging and Corresponding Probe Measurement

D. KALITA, B. KAKATI, B. K. SAIKIA, M. BANDYOPADHYAY and S. S. KAUSIK

Physics of Plasmas, 22, 113704, 2015

Neutron Flux Spectra Investigations in Breeding Blanket Assembly Containing Lithium Titanate and Lead Irradiated with DT Neutrons

SHRICHAND JAKHAR, S. TIWARI, M. ABHANGI, V. CHAUDHARI, R. MAKWANA, C.V.S. RAO, T.K. BASU, D. MANDAL

Fusion Engineering and Design, 100, 619-628, 2015

(IPR/RR-729/2015)

Optimal Design of Divertor Heat Sink with Different Geometric Configurations of Sectorial Extended Surfaces

SANDEEP RIMZA, KAMALAKANTA SATPATHY, SAMIR KHIRWADKAR, KARUPANNA VELUSAMY

Fusion Engineering and Design, 100, 581-595, 2015

Study of Plasma Nitriding and Nitrocarburizing for Higher Corrosion Resistance and Hardness of 2205 Duplex Stainless Steel

J. ALPHONSA, V.S. RAJA, S. MUKHERJEE

Corrosion Science, 100, 121-132, 2015

Two-Dimensional Studies of Relativistic Electron Beam Plasma Instabilities in an Inhomogeneous Plasma

CHANDRASEKHAR SHUKLA, AMITA DAS and KARTIK PATEL

Physics of Plasmas, 22, 112118, 2015

Simulation Study of Induced EMFs and the Suppression during SST-1 Start-Up

V. JAIN, D. SHARMA, A. VARDHRAJULU, C.N. GUPTA, R. SRINIVASAN, R. DANIEL

Fusion Engineering and Design, 100, 287-292, 2015

Effect of W and Ta on Creep-Fatigue Interaction Behavior of Reduced Activation Ferritic-Martensitic (RAFM) Steels

V. SHANKAR, K. MARIAPPAN, R. SANDHYA K. LAHA, T. JAYAKUMAR, E.R. KUMAR

Fusion Engineering and Design, 100, 314-320, 2015

Searches for Continuous Gravitational Waves from Nine Young Supernova Remnants

J. AASI, A. KUMAR ET.AL.

Astrophysical Journal, 813, 39, 2015

An Approach to Verification and Validation of MHD Codes for Fusion Applications

S. SMOLENTSEV, S. BADIA, R. BHATTACHARYAY, L. BUHLER, L. CHEN, Q. HUANG, H.G. JIN, D. KRASNOV, D.W. LEE, E. MAS DE LES VALLS, C. MISTRANGELO, R. MUNIPALLI, M.-J. NI, D. PASHKEVICH, A. PATEL, G. PULUGUNDLA, P. SATYAMURTHY, A. SNEGIREV, V. SVIRIDOV, P. SWAIN, T. ZHOU, O. ZIKANOV

Fusion Engineering and Design, 100, 65-72, 2015

Facilities, Testing Program and Modeling Needs for Studying Liquid Metal Magneto hydrodynamic Flows in Fusion Blankets

L. BUHLER, C. MISTRANGELO, J. KONYS, R. BHATTACHARYAY, Q. HUANG, D. OBUKHOV, S. SMOLENTSEV, M. UTILI

Fusion Engineering and Design, 100, 55-64, 2015

Online Impedance Matching System for ICRH-RF Experiments on SST-1 Tokamak

R. JOSHI, M. SINGH, H.M. JADAV, K. MISHRA, RAJ SINGH, S.V. KULKARNI, D. BORA, ICRH-RF GROUP

Fusion Engineering and Design, 100, 293-300, 2015

Effect of Microwave and Conventional Sintering on Densification, Microstructure and Dielectric Properties of BZT-xCr₂O₃ Ceramics

SWATHI MANIVANNAN, ANDREWS JOSEPH,
P.K. SHARMA, K.C. JAMES RAJU, DIBAKAR
DAS

Ceramics International, 41, 10923-10933, 2015

Multidirectional Plasma Flow Measurement by
Gundestrup Probe in Scrape-Off Layer of ADITYA
Tokamak

DEEPAK SANGWAN, RATNESHWAR JHA and
RAKESH L. TANNA

Physics of Plasmas, 22, 112501, 2015
(IPR/RR-720/2015)

Dusty Plasma Experimental (DPEx) Device for
Complex Plasma Experiments with Flow

S. JAISWAL, P. BANDYOPADHYAY and A. SEN
Review of Scientific Instruments, 86, 113503,
2015

(IPR/RR-732/2015)

Low-Temperature Dyeing of Silk Fabric using
Atmospheric Pressure Helium/Nitrogen Plasma

M.D.TELI, K.K. SAMANTA, P.PANDIT, S.
BASAK, S.K.CHATTOPADHYAY

Fibers and Polymers, 16, 2375- 2383, 2015

Positron Annihilation Lifetime Measurement
and X-Ray Analysis on 120 MeV Au⁺⁷ Irradiated
Polycrystalline Tungsten

CHARU LATA DUBE, PAWAN KUMAR
KULRIYA, DHANADEEP DUTTA, PRADEEP K.
PUJARI, YASHASHRI PATIL, MAYUR MEHTA,
PRIYANKA PATEL, SAMIR S. KHIRWADKAR

Journal of Nuclear Materials, 467, 406-412,
2015

Control Methodology and Test Modes during the
Qualification Test of the ITER Cold Circulator

R. BHATTACHARYA, B. SARKAR, H.
VAGHELA, P. PATEL, M. SRINIVASA, H.-
S. CHANG, T. ISONO, KATSUMI KAWANO,
MINORU SATO, M. CHALIFOUR

Physics Procedia, 67, 288-293, 2015

Crystal Growth of Ru-Doped Congruent LiNbO₃
and Investigation of Crystalline Perfection and
Optical Properties

B. RISCOB, I.BHAUMIK, S. GANESA
-MOORTHY, R. BHATT, N.VIJAYAN, K. ZIMIK,
A.K.KARNAL, G. BHAGAVANNARAYANA,

P.K.GUPTA

**Journal of Applied Crystallography, 48, 1753-
1760, 2015**

Acceptance Plan and Performance Measurement
Methodology for the ITER Cryoline System

S. BADGUJAR, M. BONNETON, N. SHAH,
M. CHALIFOUR, H.-S. CHANG, E. FAUVE, A.
FORGEAS, N. NAVION-MAILLOT, B. SARKAR

Physics Procedia, 67, 48-53, 2015

Investigation of Thermal Equilibrium around an
Accidental Event and Impact on Possibly Enclosed
Surrounding Environment

BISWANATH SARKAR, NITIN SHAH, KETAN
CHOUKEKAR, HIMANSHU KAPOOR, UDAY
KUMAR, JOTIRMOY DAS, RITENDRA
BHATTACHARAYA, HITENSINH VAGHELA,
SRINIVASA MURALIDHARA

Physics Procedia, 67, 613-618, 2015

Cool Down Experiences with the SST-1 Helium
Cryogenics System Before and After Current
Feeders System Modification

R. PATEL, P. PANCHAL, R. PANCHAL, J.
TANK, G. MAHESURIYA, D. SONARA,
G.L.N. SRIKANTH, A. GARG, N. BAIRAGI, D.
CHRISTIAN, K. PATEL, P. SHAH, H. NIMAVAT,
R. SHARMA, J.C. PATEL, N.C. GUPTA, U.
PRASAD, A.N. SHARMA, V.L. TANNA, S.
PRADHAN

Physics Procedia, 67, 170-175, 2015

First Operational Results with the SST-1
Superconducting Magnet & its Cryogenics

S. PRADHAN, V. TANNA, A. SHARMA, Z.
KHAN, U. PRASAD, K. DOSHI, Y. KHRISTI, B.
PARGHI, M. BANOUDHA, G. MAHESURIA, R.
PATEL, P. PANCHAL, R. PANCHAL, J. TANK,
D. SONARA, D. SHARMA, M. VORA, A.
VARADARAJULU

Physics Procedia, 67, 756-761, 2015

Parametric Study of a Pin-Plane Probe in
Moderately Magnetized Plasma

S BINWAL, S GANDHI, H KABARIYA, and S K
KARKARI

Measurement Science and Technology, 26,
125015, 2015

Proof-of-Concept Experiment for On-Line Laser Induced Breakdown Spectroscopy Analysis of Impurity Layer Deposited on Optical Window and Other Plasma Facing Components of Aditya Tokamak

GULAB SINGH MAURYA, ROHIT KUMAR, AJAI KUMAR, and AWADHESH KUMAR RAI
Review of Scientific Instruments, 86, 123112, 2015

Radiation Reaction Effect on Laser Driven Auto-Resonant Particle Acceleration

V. SAGAR, S. SENGUPTA, P.K.KAW
Physics of Plasmas, 22, 123102, 2015

Comparative Study of Electrical Breakdown Properties of Deionized Water and Heavy Water under Pulsed Power Conditions

G. VEDAPRAKASH, R. KUMAR, K. SAURABH, NASIR, V. P. ANITHA, M. B. CHOWDHURI and A. SHYAM

Review of Scientific Instruments, 87, 015115, 2016
(IPR/RR-706/2014)

Effect of Microwave Power on Electron Temperature and Electron Density in Deuterium Plasma Generated By Electron Cyclotron Resonance

A. T. T. MOSTAKO, S. VALA, R. J. MAKWANA, N. VIRANI, J. GHOSH, R. MANCHANDA, C. V. S. RAO, and T. K. BASU

IEEE Transactions on Plasma Science, 44, 7-14, 2016

Controllable Transition from Positive Space Charge to Negative Space Charge in an Inverted Cylindrical Magnetron

R. RANE, M. BANDYOPADHYAY, M. RANJAN and S. MUKHERJEE

Physics of Plasmas, 23, 013514, 2016
(IPR/RR-744/2015)

A Dipole Probe for Electric Field Measurements in the LVPD

P K SRIVASTAVA, L M AWASTHI, G RAVI, SUNIL KUMAR and S K MATTOO

Measurement Science and Technology, 27, 1-12, 2016

Multiple Wall-Reflection Effect in Adaptive-Array Differential-Phase Reflectometry on QUEST

H. IDEI, K. MISHRA, M.K. YAMAMOTO, A. FUJISAWA, Y. NAGASHIMA, M. HAMASAKI, Y. HAYASHI, T.ONCHI, K. HANADA, H.ZUSHI and QUEST team

Journal of Instrumentation, 11, 2016

Droplet Shaped Anode Double Layer and Electron Sheath Formation in Magnetically Constricted Anode

S. CHAUHAN, M. RANJAN, M. BANDYOPADHYAY, and S. MUKHERJEE

Physics of Plasmas, 23, 013502, 2016
(IPR/RR-756/2015)

Design of the 1.5 MW, 30-96 MHz Ultra-Wideband 3 dB High Power Hybrid Coupler for Ion Cyclotron Resonance Frequency (ICRF) Heating in Fusion Grade Reactor

RANA PRATAP YADAV, SUNIL KUMAR, and S. V. KULKARNI

Review of Scientific Instruments, 87, 014703, 2016

Sub- and Super-Luminal Propagation of Structures Satisfying Poynting-Like Theorem for Incompressible Generalized Hydrodynamic Fluid Model Depicting Strongly Coupled Dusty Plasma Medium

VIKRAM DHARODI, AMITA DAS, BHAVESH PATEL and PREDHIMAN KAW

Physics of Plasmas, 23, 013707, 2016

Search of the Orion Spur For Continuous Gravitational Waves Using a Loosely Coherent Algorithm on Data from LIGO Interferometers

J. AASI, M. K. GUPTA, Z. KHAN, A. KUMAR, A. K. SRIVASTAVA, et al.

Physical Review D, 93, 042006, 2016

Nonlinearly Interacting Trapped Particle Solitons in Collisionless Plasmas

DEBRAJ MANDAL and DEVENDRA SHARMA

Physics of Plasmas, 23, 022108, 2016
(IPR/RR-734/2015)

Overview of Ion Source Characterization Diagnostics in INTF

M. BANDYOPADHYAY, DASS SUDHIR, M. BHUYAN, J. SONI, H. TYAGI, J. JOSHI, A. YADAV, C. ROTTI, DEEPAK PARMAR, H. PATEL, S. PILLAI, and A. CHAKRABORTY
Review of Scientific Instruments, 87, 02B906, 2016

Physics-Electrical Hybrid Model for Real Time Impedance Matching and Remote Plasma Characterization in RF Plasma Sources
 D. SUDHIR, M. BANDYOPADHYAY, and A. CHAKRABORTY
Review of Scientific Instruments, 87, 02B312, 2016

Slowing and Stopping of Wave in Dispersive Metamaterial Loaded Helical Guide
 DUSHYANT K. SHARMA and SURYA K. PATHAK
Optics Express, 24, 2687, 2016

Conceptual Design of a Permanent Ring Magnet Based Helicon Plasma Source Module Intended to be used in a Large Size Fusion Grade Ion Source
 ARUN PANDEY, DASS SUDHIR, M. BANDYOPADHYAY, A. CHAKRABORTY
Fusion Engineering and Design, 103, 1-7, 2016

Conditioning of SST-1 Tokamak Vacuum Vessel by Baking and Glow Discharge Cleaning
 ZIAUDDIN KHAN, SIJU GEORGE, PRATIBHA SEMWAL, KALPESHKUMAR R. DHANANI, FIROZKHAN S. PATHAN, YUVAKIRAN PARAVASTU, DILIP C. RAVAL, GATTU RAMESH BABU, MOHAMMED SHOAB KHAN, SUBRATA PRADHAN
Fusion Engineering and Design, 103, 69-73, 2016

High Heat Flux Testing of Divertor Plasma Facing Materials and Components Using the HHF Test Facility at IPR
 YASHASHRI PATIL, S S KHIRWADKAR, SUNIL BELSARE, RAJAMANNAR SWAMY, SUDHIR TRIPATHI, KEDAR BHOPE and SHAILESH KANPARA
Physica Scripta, 2016, 1-6, 2016

Thermomechanical Analysis of Preheat Effect on Grade P91 Steel during GTA Welding

M. ZUBAIRUDDIN, S. K. ALBERT, M. VASUDEVAN, S. MAHADEVAN, V. CHAUDHRI, and V. K. SURI
Materials and Manufacturing Processes, 31, 366-371, 2016

First Low Frequency All-Sky Search for Continuous Gravitational Wave Signals
 J. AASI, M. K. GUPTA, Z. KHAN, A. KUMAR, A. K. SRIVASTAVA, et. al.
Physical Review D - Particles, Fields, Gravitation and Cosmology, 93, 042007, 2016

Astrophysical Implications of the Binary Black Hole Merger GW150914
 B. P. ABBOTT, G. GAUR, M. K. GUPTA, Z. KHAN, A. K. SRIVASTAVA, et.al
Astrophysical Journal Letters, 818, L22, 2016

Measurement of ^{55}Fe (n,p) Cross Sections by the Surrogate-Reaction Method for Fusion Technology Applications
 BHAWNA PANDEY, V. V. DESAI, S. V. SURYANARAYANA, B. K. NAYAK, A. SAXENA, E. T. MIRGULE, S. SANTRA, K. MAHATA, R. MAKAWANA, M. ABHANGI, T. K. BASU, C. V. S. RAO, S. JAKHAR, S. VALA, B. SARKAR, H. M. AGRAWAL, G. KAUR, P. M. PRAJAPATI, ASIM PAL, D. SARKAR, and A. KUNDU
Physical Review C - Nuclear Physics, 93, 021602, 2016

Prospects for Observing and Localizing Gravitational-Wave Transients with Advanced LIGO and Advanced Virgo
 B.P ABBOTT, G. GAUR, M. K. GUPTA, Z. KHAN, A. K. SRIVASTAVA et al.
 (LIGO Scientific Collaboration and Virgo Collaboration)
Living Reviews in Relativity, 19, 1-39, 2016

Charge Distribution over Dust Particles Configured with Size Distribution in a Complex Plasma
 SHIKHA MISRA, SANJAY K. MISHRA
European Physical Journal D, 70, 43, 2016

Effect of Collisions on Photoelectron Sheath in a Gas

MAHENDRA SINGH SODHA and S. K. MISHRA
Physics of Plasmas, 23, 022115, 2016

All-Sky Search for Long-Duration Gravitational Wave Transients with Initial LIGO

P. ABBOTT, G. GAUR, M. K. GUPTA, Z. KHAN, A. K. SRIVASTAVA, et al.

(The LIGO Scientific Collaboration and the Virgo Collaboration)

Physical Review D, 93, 042005, 2016

Observation of Gravitational Waves from a Binary Black Hole Merger

B.P. ABBOTT, G. GAUR, M. K. GUPTA, Z. KHAN, A. K. SRIVASTAVA, et al. (LIGO Scientific Collaboration and Virgo Collaboration)

Physical Review Letters, 116, 061102, 2016

Wakes and Precursor Soliton Excitations by a Moving Charged Object in Plasma

SANAT KUMAR TIWARI and ABHIJIT SEN

Physics of Plasmas, 23, 022301, 2016

(IPR/RR-760/2015)

A Comparison between Finite Element Modeling and Various Thermographic Non-Destructive Testing Techniques for the Quantification of the Thermal Integrity of Macro-Brush Plasma Facing Components used in a Tokamak

SANTOSH P. PANDYA, SHWETANG N. PANDYA, YASHASHRI V. PATIL, DEEPU S. KRISHNAN, MENAKA MURUGESAN, D. SHARATH, K. PREMJI SINGH, MD. SHOAIB KHAN, M. ARAFAT, N. BIJU, SAMIR S. KHIRWADKAR, JAGANNATHAN GOVIDARAJAN, B. VENKATRAMAN and KRISHNAN BALASUBRAMANIAM

Review of Scientific Instruments, 87, 024901, 2016

Arc Location Predictor on a 2D Composite Surface in Vacuum

R.S. JOSHI and S.B. GUPTA

IEEE Transactions on Dielectrics and Electrical Insulation, 23, 7422539, 2016

Life Estimation of Knee Joint Prosthesis by Combined Effect of Fatigue and Wear

B.R. RAWAL, AMIT YADAV and VINOD PARE

Procedia Technology, 23, 60-67, 2016

Multiphysics Simulation of Laser Cladding Process to Study the Effect of Process Parameters on Clad Geometry

R PAREKH, RK BUDDU, RI PATEL

Procedia Technology, 23, 529-536, 2016

Titanium Nitride Deposition on Aluminum for Adhesion Promotion

A.SUBRAMANIAN, T.PRATAP,D.A.KURUP,G. THANGARAJ, S. BHOUMIK, S. MUKHERJEE, and R. RANE

Surface Engineering, 32, 272, February 2016

Tearing and Surface Preserving Electron Magnetohydrodynamic Modes in a Current Layer

GURUDATT GAUR and PREDHIMAN K. KAW

Physics of Plasmas, 23, 032106, 2016

(IPR/RR-757/2015)

Surface Modification by Atmospheric Pressure Air Plasma Treatment to Improve Dyeing with Natural Dyes: An Environment Friendly Approach for Leather Processing

HEMEN DAVE, LALITA LEDWANI, S. K. NEMA

Plasma Chemistry and Plasma Processing, 36, 599-613, 2016

LabVIEW Software for Analyzing Langmuir Probe Characteristics in Magnetized Plasma

S. GANDHI, S. BINWAL, H. KABARIYA, S.K. KARKARI

Journal of Instrumentation, 11, T03003, 2016

(IPR/RR-745/2015)

Dynamics of Three-Dimensional Radiative Structures during RMP Assisted Detached Plasmas on the Large Helical Device and Its Comparison with EMC3-EIRENE Modeling

SHWETANG N. PANDYA, BYRON J. PETERSON, MASAHIRO KOBAYASHI, KATSUMI IDA, KIYOFUMI MUKAI, RYUICHI SANO, JUNICHI MIYAZAWA, HIROHIKO TANAKA, SUGURU MASUZAKI, TSUYOSHI AKIYAMA, GEN MOTOJIMA, NORIYASU OHNO, and LHD EXPERIMENT GROUP

Nuclear Fusion, 56, 1-11, 2016



E.1.2 Conference Papers

Can We Estimate Plasma Density in ICP Driver through Electrical Parameters in RF Circuit?

M. BANDYOPADHYAY, DASS SUDHIR, and A. CHAKRABORTY

AIP Conference Proceedings, 1655, 020013, 2015

Infrared Imaging Diagnostics for INTF ion beam
D. SUDHIR, M. BANDYOPADHYAY, R. PANDEY, J. JOSHI, A. YADAV, C. ROTTI, M. BHUYAN, G. BANSAL, J. SONI, H. TYAGI, K. PANDYA, and A. CHAKRABORTY

AIP Conference Proceedings, 1655, 060011, 2015

High Speed Analog Fiber Optical Transmission Link Based on Voltage to Frequency Converter Technique for ITER-India Gyrotron Test Facility

V. RATHOD, R. PARMAR, D. MANDGE, R. SHAH, S.L. RAO

2015 International Conference on Industrial Instrumentation and Control, ICIC 2015, 7150830, 687-691, 2015

Enhanced Group Velocity Characteristics of A ENG Cladded Metamaterial Loaded Helical Guide
D.K.SHARMA, S.K. PATHAK

Progress in Electromagnetics Research Symposium, 486- 488, 6-9, 2015

Broadband Cross Polarization Converter Formed By Twisted F-Shaped Chiral Metamaterial
D.K.SHARMA, S.K. PATHAK

Progress in Electromagnetics Research Symposium, 1479- 1481, 6-9, 2015

A Multiphysics Investigation of RF Dry Loads

YOGESH JAIN, HARISH DIXIT, AVIRAJ JADHAV, ALICE CHEERAN, VIKAS GUPTA, AND PROMOD K. SHARMA

IEEE Bombay Section Symposium, Mumbai, 10-11 September 2015

Advanced Safety Measures Implemented in Negative Neutral Beam (NNB) HVPS Facility at IPR

A. GAHLAUT, V. MAHESH, A.K. CHAKRABORTY, K.G. PARMAR, B.K. PRAJAPATI, D.V. MODI, D. PARMAR, H.

SHISHANGIYA, M.N. VISHNUDEV, J. SONI, G. BANSAL, M. BANDOPADHYAY, R.K. YADAV, K. PANDYA, J. BHAGORA, H. TYAGI and H. MISTRI

32nd DAE Safety & Occupational Health Professionals Meet, Raja Ramanna Centre for Advanced Technology, Indore, 32, 5-7 October 2015

Implementation of Safety Measures of New High Heat Flux Test Facility at IPR

SUNIL BELSARE, RAJAMANNAR SWAMY, TUSHAR PATEL, SAMIR KHIRWADKAR, DEVENDRA MODI, YASHASHRI PATIL, KEDAR BHOPE and PRAKASH MOKARIA

32nd DAE Safety & Occupational Health Professionals Meet, Raja Ramanna Centre for Advanced Technology, Indore, 46, 5-7 October 2015

Safety and Environment (S&E) Aspects of Tokamak-Type Fusion Power Reactors - An Overview

BHARAT DOSHI and D. CHENNA REDDY
32nd DAE Safety & Occupational Health Professionals Meet, Raja Ramanna Centre for Advanced Technology, Indore, 89, 5-7 October 2015

Testing and Preventive Maintenance of Electrical Power Systems in Substation for Safety and Reliability

CHANDRA KISHOR GUPTA
32nd DAE Safety & Occupational Health Professionals Meet, Raja Ramanna Centre for Advanced Technology, Indore, 115, 5-7 October 2015

Safety Aspects in Helium Recovery System at IPR
SAMIRAN SHANTI MUKHERJEE, D.V. MODI, RANJANA GANGRADEY, P. PANCHAL, J. S. MISHRA, D. TRIPATHI, S. KASTHURIRENGAN, JYOTI AGARWAL and PRATIK NAYAK

32nd DAE Safety & Occupational Health Professionals Meet, Raja Ramanna Centre for Advanced Technology, Indore, 167, 5-7 October 2015

Study of the Safety Criteria and the Radiation Limit in Microwave Coal Gasification Experiments

VISHAL JAIN

32nd DAE Safety & Occupational Health Professionals Meet, Raja Ramanna Centre for Advanced Technology, Indore, 179, 5-7 October 2015

Safety Management System Implementation at IPR
D.V. MODI and D. CHENNA REDDY

32nd DAE Safety & Occupational Health Professionals Meet, Raja Ramanna Centre for Advanced Technology, Indore, 180, 5-7 October 2015

Thermal Performance Analysis of Cryogenic System for Cooling of Superconducting Magnets at 4K Temperature Level

H. VAGHELA, B. SARKAR, A. BISHT, and V J LAKHERA

5th Nirma University International Conference on Engineering, Ahmedabad, Gujarat, 26-28 November 2015

Preparation & Characterization of SiO₂ Interface Layer by Dip Coating Technique on Carbon Fibre for Cf/SiC Composites

KUNDAN KUMAR, C. JARIWALA, R. PILLAI, N. CHAUHAN, and P. M. RAOLE

AIP Conference Proceedings, 1675, 020046, 2015

The Effect of Spraying Parameters on Micro-Structural Properties of WC-12%Co Coating Deposited on Copper Substrate by HVOF Process
NISHIT SATHWARA, C. JARIWALA, N. CHAUHAN, P. M. RAOLE, and D. K. BASA

AIP Conference Proceedings, 1675, 030057, 2015

Interfacing ICRH DAC System with WEB

R. JOSHI, H.M. JADAV, and S.V.KULKARNI

2015 International Conference on Advances in Computing, Communications and Informatics, ICACCI 2015, 1170-1173, 2015

Studies of Thermal Behavior on Activated Carbons for the Selection of Regeneration Scheme

SAMIRAN MUKHERJEE, PRATIK NAYAK, JYOTI AGARWAL, and RANJANA GANGRADEY

Materials Today: Proceedings, 2, Pages 1225-1229, 2015

Multiple Species Plasma Boundary Criterion with Non-Degenerate Entry Flows

PRABHAT KUMAR DUBEY, NISHCHHAL YADAV and DEVENDRA SHARMA

AIP Conference Proceedings, 1670, 030008, 2015

Hydrogen in Stainless Steel as Killing Agent for UHV: A Review

MANOJ KUMAR GUPTA, ABHINAV PRIYADARSHI, and ZIAUDDIN KHAN

Materials Today: Proceedings, 2, 1074-1081, 2015

Value Engineering in System of Cryoline and Cryo-Distribution for ITER: In-Kind Contribution from India

B SARKAR, N SHAH, H VAGHELA, R BHATTACHARYA, K CHOUKEKAR, P PATEL, H-S CHANG, S BADGUJAR and M CHALIFOUR

IOP Conference Series: Material Science and Engineering, 101, 012036, 2015

Pumping Speed Offered by Activated Carbon at Liquid Helium Temperatures by Sorbents Adhered to Indigenously Developed Hydroformed Cryopanel

RANJANA GANGRADEY, SAMIRAN SHANTI MUKHERJEE, PARESH PANCHAL, PRATIK NAYAK, JYOTI AGARWAL, CHIRAG RANA, S KASTHURIRENGAN, JYOTI SHANKAR MISHRA, HARESH PATEL, PAWAN BAIRAGI, VRUSHABH LAMBADE and REENA SAYANI

IOP Conference Series: Material Science and Engineering, 101, 012044, 2015

Design Realization towards the Qualification Test of ITER Cold Circulator

R BHATTACHARYA, B SARKAR, H VAGHELA, P PATEL, J DAS, M SRINIVASA, and V SHUKLA

IOP Conference Series: Material Science and Engineering, 101, 012040, 2015

Loads Specification and Embedded Plate Definition for the ITER Cryoline System

SBADGUJAR, LBENKHEIRA, MCHALIFOUR, A FORGEAS, N SHAH, H VAGHELA, and B SARKAR

IOP Conference Series: Material Science and Engineering, 101, 012035, 2015

Materials Research and Development Opportunities in Fusion Reactors
S MUKHERJEE and N I JAMNAPARA
Proceedings of the National Science Academy, 81, 827-839, 2015

Development of Traveling Wave Resonator Based Test Bed for High Power Transmission Line Component Testing
AKHIL JHA, JVS HARIKRISHNA, P AJESH, ROHIT ANAND, RAJESH TRIVEDI, and APARAJITA MUKHERJEE
AIP Conference Proceedings, 1689, 070006, 2015

Development of Mismatch Transmission Line (MMTL) System for ICH&CD Test Rig
P AJESH, AKHIL JHA, ROHIT ANAND, JVS HARIKRISHNA, RAJESH TRIVEDI, and APARAJITA MUKHERJEE
AIP Conference Proceedings, 1689, 070007, 2015

Enhancement of Surface Properties of Maraging Steel C300 by Plasma Nitriding
NAND KUMAR, B. GANGULI, S. SHARMA
NCIMACEMT-2016 Conference Proceedings, International Journal of Engineering Research and Technology, 4, 53, March 2016

Surface Modification of 17-4 PH Stainless Steel by Plasma Nitriding
SANGITA JADEJA, B. GANGULI, D.K. BASA
NCIMACEMT-2016 Conference Proceedings, International Journal of Engineering Research and Technology, 4, 138, March 2016

E.1.3 Book Chapters

Plasma Nitriding - An Eco Friendly Indigenously Developed Process for Enhancing the Life of Industrial Components, A case study of journey from laboratory to industry
J. ALPHONSA, G. JHALA, S. B. GUPTA, S. MUKHERJEE

Transforming India through Quality Leadership”, page 348-355, American Society for Quality India Pvt. Ltd., 2015. ISBN: 9788193021613

Investigation of sticking behaviour of silver atoms on patterned substrate with RBS

M. RANJAN

Nanoscale Excitation in Emergent Materials - NEEM 2015, Superstripes Press, Rome, Italy, 2015 Editor(s): Augusto Marcelli, Chidambara Balasubramanian

ISBN: 9788866830450

E.1.4. Books Edited

Nanoscale Excitation in Emergent Materials - NEEM 2015

Co-edited: Chidambara Balasubramanian

Superstripes Press, Rome, 2015

ISBN 9788866830450

E 2. Internal Research And Technical Reports

E 2. 1 Research Reports

SUPERCONDUCTING SAMPLE CHARACTERIZATION FACILITY DEVELOPMENT EMPLOYING PULSE TUBE CRYOCOOLER AND ITS VALIDATION

ANANYA KUNDU, ANEES BANO, SUBRAT KUMAR DAS, DHAVAL BHAVSAR, and SUBRATA PRADHAN

IPR/RR-727/2015 APRIL 2015

GENERATION OF MULTIPLE TOROIDAL DUST VORTICES BY NON-MONOTONIC DENSITY GRADIENT IN DIRECT CURRENT GLOW DISCHARGE PLASMA

MANJIT KAUR, SAYAK BOSE, P. K. CHATTOPADHYAY, D. SHARMA, J. GHOSH, Y. C. SAXENA, and EDWARD THOMAS JR.

IPR/RR-728/2015 MAY 2015

SIMULATION STUDY FOR SLIT APERTURE BASED EXTRACTION SYSTEM OF A POSITIVE ION SOURCE

B. CHOKSI, S. K. SHARMA, V. PRAHLAD, P.

BHARATHI, and U.K. BARUAH
IPR/RR-730/2015 MAY 2015

PARAMETRIC STUDY ON THE PERFORMANCE OF A PLANE-PIN PROBE IN MAGNETIZED PLASMA

S. BINWAL, S. GANDHI, H. KABARIYA and S. K. KARKARI
IPR/RR-731/2015 JUNE 2015

DESIGN OF THE 1.5MW ULTRA-WIDEBAND 3DB HIGH POWER HYBRID COUPLER FOR ICRF HEATING IN FUSION GRADE REACTOR
RANA PRATAP YADAVA, SUNIL KUMAR, and S.V. KULKARNI

IPR/RR-733/2015 JUNE 2015

CPED - A TEST BED FOR STUDYING DUST VORTICES AND OTHER COLLECTIVE PHENOMENA

MANJIT KAUR, SAYAK BOSE, P. K. CHATTOPADHYAY, J. GHOSH, and Y. C. SAXENA

IPR/RR-735/2015 JULY 2015

MEASUREMENT OF NEUTRON INDUCED HYDROGEN PRODUCTION CROSS-SECTION FROM RADIONUCLIDE ^{55}Fe BY SURROGATE REACTION METHOD FOR FUSION TECHNOLOGY

BHAWNA PANDEY, B.K. NAYAK, ALOK SAXENA, S.V. SURYANARAYANA, V. DESAI, R. MAKAWANA, M. ABHANGI, T.K. BASU, CVS RAO, S. JAKHAR, S. VALA, B. SARKAR, H.M. AGRAWAL, G. KAUR, P.M. PRAJAPATI, D. SARKAR, and A. KUNDU

IPR/RR-737/2015 JULY 2015

NEUTRONICS ANALYSIS AND SHIELDING OPTIMIZATION FOR X-RAY CRYSTAL SPECTROMETER OF ITER

P.V. SUBHASH, GUNJAN INDAULIYA, T. SAI CHAITANYA, S. JAKHAR, SANJEEV VARSHNEY, SIDDHARTH KUMAR, K. RAJA KRISHNA, NIRAV BHALIYA, ROBIN BARNESLEY, BERNASCOLLE PHILLIPE, P. SHRISHAIL, and VINAY KUMAR

IPR/RR-738/2015 JULY 2015

ANALYSIS OF EDGE TURBULENCE IMAGING DATA IN NSTX OHMIC PLASMAS
SANTANU BANERJEE, and S. J. ZWEBEN
IPR/RR-739/2015 JULY 2015

ARC CURRENT WAVEFORM PREDICTOR ON A 2D COMPOSITE SURFACE IN VACUUM
RASHMI S. JOSHI, and SURYAKANT B. GUPTA
IPR/RR-740/2015 JULY 2015

PRELIMINARY CORROSION STUDIES OF INDIAN REDUCED FERRITIC MARTENSITIC STEEL WITH STAGNANT LEAD-LITHIUM AT 823 K

A. SARADA SREE, HEMANG S. AGRAVAT, JIGNESH CHAUHAN, and E. RAJENDRAKUMAR

IPR/RR-741/2015 JULY 2015

2-D STUDIES OF RELATIVISTIC ELECTRON BEAM PLASMA INSTABILITIES IN AN INHOMOGENEOUS PLASMA

CHANDRASHEKHAR SHUKLA, and AMITA DAS

IPR/RR-742/2015 JULY 2015

INHOMOGENEOUS ELECTRON TEMPERATURE ASSISTED NEGATIVE ION PRODUCTION IN A MAGNETIZED PLASMA COLUMN

S. K. KARKARI, S. BINWAL, M. SHASTRI, S. GANDHI, H. KABARIYA and M. BANDYOPADHYAY

IPR/RR-743/2015 AUGUST 2015

KOLMOGOROV FLOW IN TWO DIMENSIONAL STRONGLY COUPLED YUKAWA LIQUID: A MOLECULAR DYNAMICS STUDY

AKANKSHA GUPTA, RAJARAMAN GANESH, and ASHWIN JOY

IPR/RR-746/2015 SEPTEMBER 2015

INFLUENCE OF HEAT INPUT CONDITIONS STUDY ON MICROSTRUCTURE AND MECHANICAL PROPERTIES OF NARROW GROOVE MULTIPASS TIG WELDS OF SS304
RAMESH KUMAR BUDDU and SANDEEP BHAGVAT

IPR/RR-747/2015 OCTOBER 2015



OPTIMIZATION OF THE DIFFUSION BONDING PARAMETER FOR SS316L/CUCRZR WITH AND WITHOUT NICKEL INTERLAYER

K.P SINGH, ALPESH PATEL, KEDAR BHOPE, NIKUNJ PATEL and S.S KHIRWADKAR
IPR/RR-748/2015 OCTOBER 2015

OPTIMIZATION OF POLOIDAL FIELD COIL SYSTEM FOR SST-2 FUSION REACTOR

D. GARG, R. SRINIVASAN, D. SHARMA and U. PRASAD

IPR/RR-749/2015 OCTOBER 2015

ACHIEVING OF ULTRAHIGH VACUUM IN AN UNBAKED CHAMBER WITH GLOW DISCHARGE CLEANING

ZIAUDDIN KHAN, PRATIBHA SEMWAL, KALPESH R DHANANI, DILIP C RAVAL and SUBRATA PRADHAN

IPR/RR-750/2015 OCTOBER 2015

AN ADVANCED HELIUM COOLED DIVERTOR HEAT SINK CONCEPT

SANDEEP RIMZA, SAMIR KHIRWADKAR and KARUPANNA VELUSAMY

IPR/RR-751/2015 OCTOBER 2015

EXPERIMENTAL OBSERVATION OF PRECURSOR SOLITONS IN A FLOWING COMPLEX PLASMA

SURABHI JAISWAL, P. BANDYOPADHYAY and A. SEN

IPR/RR-752/2015 OCTOBER 2015

INTERPLAY BETWEEN ENERGETIC ION FLUX AND RE-DEPOSITION OF SPUTTERED ATOMS DURING SPUTTER EROSION AT NORMAL INCIDENCE IN ACCORDANCE WITH NONLINEARITY

PURVEE JOSHI, MUKESH RANJAN, STEFAN FACSKO, RENE HUEBNER and SUBROTO MUKHERJEE

IPR/RR-753/2015 OCTOBER 2015

SUB AND SUPER-LUMINAR PROPAGATION OF STRUCTURES SATISFYING POYNTING LIKE THEOREM FOR INCOMPRESSIBLE GHD FLUID MODEL DEPICTING STRONGLY COUPLED DUSTY PLASMA MEDIUM

VIKRAM DHARODI, AMITA DAS, BHAVESH PATEL and PREDHIMAN KAW

IPR/RR-754/2015 OCTOBER 2015

THERMO-MECHANICAL ANALYSIS OF MULTI-PASS GTA WELDING OF GRADE 91 STEEL PLATES

M. ZUBAIRUDDIN, S. K. ALBERT, M. VASUDEVAN, S. MAHADEVAN, V. CHAUDHARI and V. K. SURI

IPR/RR-755/2015 OCTOBER 2015

MINORITY HEATING SCENARIOS IN 4He(H) AND 3He(H) SST-1 PLASMA

ASIM KUMAR CHATTOPADHYAY

IPR/RR-758/2015 NOVEMBER 2015

MEASUREMENT OF DC PLASMA SHEATH POTENTIALS USING LASER HEATED EMISSIVE PROBES

K. VARA PRASAD, PAYAL MEHTA, ARUN SARMA, and J. GHOSH

IPR/RR-759/2015 NOVEMBER 2015

BEHAVIOR OF NON-THERMAL ELECTRONS DURING ECR PRE-IONIZATION AT ADITYA TOKAMAK

S. PUROHIT, Y. S. JOISA, J. V. RAVAL, M. B. CHOWDHURI, B. K. SHUKLA, R. MANCHANDA, N. RAMAIYA, U. C. NAGORA, P. K. ATREY, R. L. TANNA, K. A. JADEJA, S. B. BHATT, C. N. GUPTA, A. KUMAR, J. GHOSH, and ADITYA TEAM

IPR/RR-761/2015 DECEMBER 2015

FLUCTUATION INDUCED GRADIENT SCALE VARIATIONS IN LIMITER SOL PLASMA TRANSPORT SIMULATIONS OF ADITYA

BIBHU PRASAD SAHOO, DEVENDRA SHARMA, RATNESHWAR JHA and YUHE FENG

IPR/RR-762/2015 DECEMBER 2015

ATOMISTIC INTERACTION OF Ag WITH SILICA UNDER SUB MONOLAYER GROWTH ON NANO RIPPLED SiO₂ SURFACE

M. BHATNAGAR, M. RANJAN, R. HELLER, K. JOLLEY, R. SMITH, S. MUKHERJEE and S. FACSKO

IPR/RR-763/2015 DECEMBER 2015

ANALYSIS OF NEUTRAL PARTICLE ANALYZER MEASUREMENTS ON THE ADITYA TOKAMAK FOR ESTIMATING NEUTRAL HYDROGEN DENSITIES AND CORE ION TEMPERATURES DURING OHMIC PLASMA DISCHARGES

KUMAR AJAY, SANTOSH P. PANDYA, SNEHLATA GUPTA AGARWAL and the ADITYA Team

IPR/RR-764/2015 DECEMBER 2015

RESIDUAL IMAGE ANALYSIS FOR OPTICAL ALIGNMENT USING A QUADRANT PHOTO DETECTOR

S. SUNIL, AMIT K SRIVASTAVA and ZIAUDDIN KHAN

IPR/RR-765/2015 DECEMBER 2015

NARROW GROOVE TIG WELD JOINTS FABRICATION AND MECHANICAL PROPERTIES CHARACTERIZATION OF 40 MM THICK SS316L SAMPLES FOR FUSION REACTOR COMPONENTS

RAMESH KUMAR BUDDU and SANDIP BHAGVAT

IPR/RR-766/2015 DECEMBER 2015

STUDY OF PLASMA NITRIDING AND NITROCARBURIZING ON AISI 430 FERRITIC STAINLESS STEEL FOR HIGH HARDNESS & CORROSION RESISTANCE

J. ALPHONSA, S. MUKHERJEE and V.S. RAJA

IPR/RR-767/2015 DECEMBER 2015

NOVEL DESIGN OF EMISSIVE PROBE FOR PLASMA POTENTIAL MEASUREMENTS

A. K. SANYASI, P. K. SRIVASTAVA and L. M. AWASTHI

IPR/RR-768/2016 JANUARY 2016

TRANSPORT AND TRAPPING OF DUST PARTICLES IN A POTENTIAL WELL CREATED BY INDUCTIVELY COUPLED DIFFUSED PLASMAS

MANGILAL CHOUDHARY, S. MUKHERJEE and P. BANDYOPADHYAY

IPR/RR-769/2016 JANUARY 2016

RELATIVISTIC ELECTRON BEAM DRIVEN

LONGITUDINAL WAKE-WAVE BREAKING IN A COLD PLASMA

RATAN KUMAR BERA, ARGHYA MUKHERJEE, SUDIP SENGUPTA and AMITA DAS

IPR/RR-770/2016 JANUARY 2016

PREPARATION OF W/CuCrZr MONO-BLOCK TEST MOCK-UP USING VACUUM BRAZING TECHNIQUE

K. P. SINGH, S. KHIRWADKAR, KEDAR BHOPE, NIKUNJ PATEL, PRAKASH MOKARIA, and MAYUR MEHATA

IPR/RR-771/2016 JANUARY 2016

OBSERVATION OF GEODESIC ACOUSTIC MODE IN SINP-TOKAMAK AND ITS BEHAVIOR WITH VARYING EDGE SAFETY FACTOR

LAVKESH LACHHVANI, J. GHOSH, P. K. CHATTOPADHYAY, NIKHIL CHAKRABARTI, and RABINDRANATH PAL

IPR/RR-772/2016 JANUARY 2016

OBSERVATION OF QUASI-COHERENT EDGE FLUCTUATIONS IN OHMIC PLASMAS ON NSTX

SANTANU BANERJEE, A. DIALLO and S. J. ZWEBEN

IPR/RR-773/2016 FEBRUARY 2016

NUMERICAL MODELLING FOR THE EFFECTIVE THERMAL CONDUCTIVITY OF LITHIUM META TITANATE PEBBLE BED WITH DIFFERENT PACKING STRUCTURES

MAULIK PANCHAL and P. CHAUDHURI

IPR/RR-774/2016 FEBRUARY 2016

PROPAGATION CHARACTERISTICS OF AN EXTREMELY ANISOTROPIC METAMATERIAL LOADED HELICAL GUIDE

DUSHYANT KUMAR SHARMA and SURYA KUMAR PATHAK

IPR/RR-775/2016 FEBRUARY 2016

EXPERIMENTAL STUDY TO IMPROVE ANTI-FELTING CHARACTERISTICS OF MERINO WOOL FIBER BY ATMOSPHERE PRESSURE AIR PLASMA

NISHA CHANDWANI, PURVI DAVE, VISHAL JAIN, S. K. NEMA and S. MUKHERJEE
IPR/RR-776/2016 FEBRUARY 2016

CHIRP-DRIVEN GIANT BGK MODES
PALLAVITRIVEDI and RAJARAMAN GANESH
IPR/RR-777/2016 FEBRUARY 2016

PHASE MIXING OF RELATIVISTICALLY INTENSE LONGITUDINAL WAVE PACKETS IN A COLD PLASMA
ARGHYA MUKHERJEE and SUDIP SENGUPTA
IPR/RR-778/2016 FEBRUARY 2016

SIMULATION AND EXPERIMENTAL VALIDATION OF SIMPLE POWER SUPPLY ARCHITECTURE FOR GENERATING HIGHER DENSITY O AUGDP IN AIR
VISHAL JAIN, ANAND VISANI, R. SRINIVASAN and VIVEK AGARWAL
IPR/RR-779/2016 MARCH 2016

PERFORMANCE ANALYSES OF MEDIUM SIZED INDIAN FUSION REACTOR
CHANDAN DANANI, B. J. SAIKIA, VINAY MENON, A. N. SHARMA, UPENDRA PRASAD, J. AGRAWAL, M. STEPHAN, NAVEEN RASTOGI, R. PRAGASH, E. RAJENDRA KUMAR, S. PRADHAN, S. KHIRWADKAR, R. GANGRADEY, R. SRINIVASAN, S. P. DESHPANDE and P. K. KAW
IPR/RR-780/2016 MARCH 2016

3-D NUCLEAR ANALYSES OF INDIAN LEAD LITHIUM COOLED CERAMIC BREEDER TBM IN ITER USING ATILA
DEEPAK AGGARWAL, CHANDAN DANANI and RANJITH KUMAR
IPR/RR-781/2016 MARCH 2016

SIMULATED THERMAL DYNAMICS OF SILVER CLUSTERS GROWN ON RIPPLED SILICA SURFACE
M. BHATNAGAR and M. RANJAN
IPR/RR-782/2016 MARCH 2016

ON THE ANOMALOUS COLLISIONAL ABSORPTION OF S-POLARIZED LASER

LIGHT IN AN UNDER-DENSE PLASMA USING A MONTE CARLO COLLISION ASSISTED PARTICLE-IN-CELL CODE

M. KUNDU
IPR/RR-783/2016 MARCH 2016

THERMOHYDRAULIC ANALYSIS OF HYDROFORMED RADIATION SHIELD PLATE
JATIN J CHOPRA, SAMIRAN MUKHERJEE, RANJANA GANGRADEY, ALKESH MAVANI and JYOTI AGARWAL
IPR/RR-784/2016 MARCH 2016

MAGNETIC FIELD EFFECT ON HYSTERESIS DYNAMICS AND LOW FREQUENCY SELF-EXCITED OSCILLATIONS IN REFLEX PLASMA SOURCE
R. RANE, M. BANDOPADHYAY, A. N. SEKHAR IYENGAR and S. MUKHERJEE
IPR/RR-785/2016 MARCH 2016

CONFINEMENT TIME OF ELECTRON PLASMA APPROACHING MAGNETIC PUMPING TRANSPORT LIMIT IN SMALL ASPECT RATIO TORUS
LAVKESH LACHHVANI, SAMBARAN PAHARI, RAJIV GOSWAMI, MANU BAJPAI, YOGESH YEOLE and P. K. CHATTOPADHYAY
IPR/RR-786/2016 MARCH 2016

AN APPROACH TO OPTIMIZE RFQ CAVITY USING SUPERFISH CODE
MRIDULA MITTAL AND RENU BAHL
IPR/RR-787/2016 MARCH 2016

SYSTEM UPGRADATION FOR SURFACE MODE NEGATIVE ION BEAM EXTRACTION EXPERIMENTS IN ROBIN
KAUSHAL PANDYA, GOURAB BANSAL, AGRAJIT GAHLAUT, JIGNESH SONI, RATNAKAR K. YADAV, VUPPUGALLA MAHESH, HIMANSHU TYAGI, KANU G. PARMAR, HIREN MISTRI, JIGHESH BHAGRA, BHAVESH PRAJAPATI, KARTIK PATEL, MANAS BHUYAN, MEHUL GOUSWAMI, MAINAK BANDYOPADHYAY and ARUN K. CHAKRABORTY
IPR/RR-788/2016 MARCH 2016

E 2. 2 Technical Reports

Development, Integration and Testing of Automated Triggering Circuit for Hybrid DC Circuit Breaker
DEVEN KANABAR, SWATI ROY, CHIRAGKUMAR DODIYA, and SUBRATA PRADHAN

IPR/TR-338/2015 (APRIL 2015)

Design, development and results from a Charge-Collector diagnostic for a Toroidal Electron Plasma Experiment

SAMBARANPAHARI, LAVKESHLACHHVANI, MANU BAJPAI, KARAN RATHOD, YOGESH YEOLE, and P. K. CHATTOPADHYAY

IPR/TR-339/2015 (APRIL 2015)

Electron Beam Profile Measurement Set-Up for High Heat Flux Test Facility at IPR

YASHASHRI PATIL, S. S. KHIRWADKAR, S. M. BELSARE, RAJAMANNAR SWAMY, K. GALODIYA, N. PATEL, T. PATEL, and P. MOKARIYA

IPR/TR-340/2015 (APRIL 2015)

Performance Study of Outgassing System Incorporating Air Baking

PARESH PANCHAL, SAMIRAN SHANTI MUKHERJEE, JYOTI AGARWAL, and RANJANA GANGRADEY

IPR/TR-341/2015 (APRIL 2015)

ICRH DAC Software Modification for Aditya Experiment Requirements

RAMESH JOSHI, H M JADAV, MANOJ PARIHAR, B R KADIA, K M PARMAR, A VARIA, GAYATRI ASHOK, Y S S SRINIVAS, SUNIL KUMAR, and S.V. KULKARNI

IPR/TR-342/2015 (MAY 2015)

Conceptual & Engineering Design of Plug-in Cryostat Cylinder for Super-Conducting Central Solenoid of SST-1

PROSENJIT SANTRA, PRABAL BISWAS, KIRIT VASAVA, SNEHAL JAYSWAL, TEJAS PEREKH, PRADEEP CHAUHAN, HITESH PATEL, and SUBRATA PRADHAN

IPR/TR-343/2015 (MAY 2015)

Design, Development, Integration and Testing of Glass Fiber Optic Based Control Signal for Remote Operation of RHVPS

MANOJ SINGH, HM JADAV, YSS SRINIVAS, PARESH PATEL, SUNIL KUMAR, and SV KULKARNI

IPR/TR-344/2015 (MAY 2015)

Design and Development of PLC based Offline Impedance Matching System for ICRH Experiment

RAMESH JOSHI, H M JADAV, ANIRUDDH MALI, S V KULKARNI, and ICRH GROUP

IPR/TR-345/2015 (MAY 2015)

LabVIEW Based Prototype Software for High Power ICRH DAC

RAMESH JOSHI, H M JADAV, ANIRUDDH MALI, YSS SRINIVAS, SUNIL KUMAR, S V KULKARNI and ICRH GROUP

IPR/TR-346/2015 (MAY 2015)

Analog Input Modules (IP320, IP330) Driver Development and Integration with ICRH DAC Software

RAMESH JOSHI, H M JADAV, S V KULKARNI, and ICRH GROUP

IPR/TR-347/2015 (MAY 2015)

Eight Channel, Scalable, Optical Gate Control Circuit for 4kV Series IGBT DC Switch

BHAVESH R KADIA, MANDEEPSINGH CHHABADA, YSS SRINIVAS, S.V. KULKARNI, and ICRH GROUP

IPR/TR-348/2015 (MAY 2015)

Indigenously Developed Bending Strain Setup for I-V Characterization of Superconducting Tapes and Wires

ARUN PANCHAL, ANEES BANO, MAHESH GHATE, PIYUSH RAJ, and SUBRATA PRADHAN

IPR/TR-349/2015 (MAY 2015)

Development of Cryostat for Pulse Tube Cryocooler system

DHAVAL BHAVSAR, ANANYA KUNDU, ANEES BANO, MAHESH GHATE, and SUBRATA PRADHAN

IPR/TR-350/2015 (JUNE 2015)

Design, Fabrication, Installation of In-Vessel Coil of SST-1 Tokamak

SNEHAL JAYSWAL, PRADEEP CHAUHAN, PROSENJIT SANTRA, HITESH PATEL, TEJAS PAREKH, PRABAL BISWAS, and SUBRATA PRADHAN
IPR/TR-351/2015 (JULY 2015)

Establishment of Helium Recovery System at IPR
SAMIRAN MUKHERJEE, RANJANA GANGRADEY, SRINIVASAN KASTHURIRENGAN, PARESH PANCHAL, and JYOTI SHANKAR MISHRA
IPR/TR-352/2015 (JULY 2015)

Numerical Studies on HHF Test Mono-Block for Divertor Applications
K. SATPATHY and S.S. KHIRWADKAR
IPR/TR-353/2015 (JULY 2015)

LabVIEW based 80 Channel Data Acquisition for ICRH-RF Transmission Lines and Diagnostics
RAMESH JOSHI, H M JADAV, ANIRUDDH MALI, S V KULKARNI & ICRH GROUP
IPR/TR-354/2015 (JULY 2015)

Conceptual Design Report of Experimental Set-Up for Determining Hydrogen Isotope Solubility in Liquid Pb-Li
SUDHIR RAI and AMIT SIRCAR
IPR/TR-355/2015 (AUGUST 2015)

Non-destructive Testing of Macro-brush type mock-ups of the Plasma Facing Component using different Infrared Thermography Techniques
SANTOSH P. PANDYA, SHWETANG N. PANDYA, YASHASHRI V. PATIL, DEEPU S. KRISHNAN, MENAKA MURUGESAN, D. SHARATH, KONGKHAN PREMJI SINGH, MD. SHOAIB KHAN, M. ARAFAT, N. BIJU, SAMIR S. KHIRWADKAR, JAGANNATHAN GOVIDARAJAN, B. VENKATRAMAN and KRISHNAN BALASUBRAMANIAM
IPR/TR-356/2015 (AUGUST 2015)

Commissioning of 10kVDC, 7A and 12VAC, 120A Integrated Power Supply for Triode based 20KW Stage CWRF Amplifiers
KIRIT M PARMAR, BHAVESH R. KADIA, Y S

S SRINIVAS, H. M. JADAV, RAMESH JOSHI, S. V. KULKARNI and ICRH Group
IPR/TR-357/2015 (AUGUST 2015)

Process Automation System for Integration and Operation of Large Volume Plasma Device
R. SUGANDHI, P. K. SRIVASTAVA, A. K. SANYASI, PRABHAKAR SRIVASTAV, L. M. AWASTHI and S. K. MATTOO
IPR/TR-358/2015 (SEPTEMBER 2015)

Determination of Plasma Temperature in SST-1
SHARAD KUMAR YADAV, P. K. KAW, A. DAS, S. K. PATHAK, S. JOISA, D. RAJU and SST-1 TEAM
IPR/TR-359/2015 (OCTOBER 2015)

Revisiting Timing and Synchronization for Multi Module Data Acquisition System on PXIe Bus
R. SUGANDHI, P. K. SRIVASTAVA, P. SRIVASTAV, A. K. SANYASI, L. M. AWASTHI, V. PARMAR, K. MAKADIA, I. PATEL and S. SHAH
IPR/TR-360/2015 (OCTOBER 2015)

Design of 4 kV, 1A Series Connected IGBT Switch for the Protection of Triode Based 2kW Stage ICRF Amplifier
BHAVESH R. KADIA, MANDEEPSINGH CHHABADA, Y. S. S. SRINIVAS, S. V. KULKARNI and ICRH Group
IPR/TR-361/2015 (NOVEMBER 2015)

Ultrasonic Evaluation of Electron Beam (EB) Welded CuCrZr to CuCrZr joints presents in Heat Transfer Element of SPIDER Beam Dump
KEDAR BHOPE, HITESH PATEL, ALPESH PATEL, JAINISH TOPIWALA, MAYUR MEHTA, CHANDRAMOULI ROTTI and SAMEER KHIRWADKAR
IPR/TR-362/2015 (DECEMBER 2015)

Digital Signal Processing on FPGA for Plasma Diagnostics
RACHANA RAJPAL, HITESH MANDALIYA, PRAMILA GAUTAM, PRAVEEN, VISMAY, UMESH, S. K. PATHAK, P. K. ATREY and R. JHA
IPR/TR-363/2015 (DECEMBER 2015)

Plasma Pyrolysis Technology and its evolution at FCIPT, Institute for Plasma Research, India

S. K. NEMA, V. JAIN, K. S. GANESHPRASAD, A. SANGHARIYAT, S. SONI, C. PATIL, V. CHAUHAN and P. I. JOHN

IPR/TR-364/2016 (JANUARY 2016)

Calculation of Error Matrix using Finesse for the supervisory control of an optical cavity

S. SUNIL, AMIT K. SRIVASTAVA and ZIAUDDIN KHAN

IPR/TR-365/2016 (JANUARY 2016)

Design of High Pressure High Temperature Water Circulation System for High Heat Flux Test Facility RAJAMANNAR SWAMY, S. S. KHIRWADKAR, and PRASHANT SINGH

IPR/TR-366/2016 (JANUARY 2016)

A 5 kA Pulsed Power Supply for Inductive and Plasma Loads in LVPD

P. K. SRIVASTAVA, S. K. SINGH, A. K. SANYASI, L. M. AWASTHI and S. K. MATTOO

IPR/TR-367/2016 (JANUARY 2016)

Design Optimization of Beam Transport System for Accelerator based 14-MeV Neutron Source

ASHA PANGHAL, SUDHIRSINH VALA, A.MANDAL, S. KUMAR, G.O. RODRIGUES, C. V. S. RAO, T. K. BASU and B. SARKAR

IPR/TR-368/2016 (JANUARY 2016)

Thermal Hydraulic Analysis of Liquid Helium Flow through Cryopanel

SAMIRAN MUKHERJEE, RANJANA GANGRADEY, REENA SAYANI, PRATIK NAYAK, and PARESH PANCHAL

IPR/TR-369/2016 (JANUARY 2016)

EPICS Interfacing to Atmega2560 Microcontroller using Bit Stream Data Transfer Serial Communication Protocol

ARNAB DAS GUPTA, AMIT K SRIVASTAVA, S. SUNIL, and ZIAUDDIN KHAN

IPR/TR-370/2016 (FEBRUARY 2016)

Electrical characterization of prototype JET ELM control coils

DEVEN KANABAR, SWATI ROY, MAHESH

GHATE, PIYUSH RAJ, ANANYA KUNDU, NITISH KUMAR, DHAVAL BHAVSAR, ARUN PANCHAL and SUBRATA PRADHAN

IPR/TR-371/2016 (MARCH 2016)

Cabling Technology for Manufacturing of Fusion Relevant Superconducting CICC Cables at IPR

MAHESH GHATE, PIYUSH RAJ, ARUN PANCHAL, DHAVAL BHAVSAR and SUBRATA PRADHAN

IPR/TR-372/2016 (MARCH 2016)

Surface modification of Brass Valves using Environment Friendly Plasma Process

S. K. NEMA, P. KIKANI, A. SANGHARIYAT, B. K. PATEL, S. K. GUPTA and N. JAMNAPARA

IPR/TR-373/2016 (MARCH 2016)

Design and development of Seal Force Test facility for Axial Isolation Valve Seal

VRUSHABH LAMBADE, JYOTI AGARWAL, PARESH PANCHAL, SAMIRAN MUKHERJEE, JYOTI SHANKAR MISHRA and RANJANA GANGRADEY

IPR/TR-374/2016 (MARCH 2016)

An overview of Outgassing rate of different structural materials and its measurement

MOHSIN BUKHARI, SAMIRAN MUKHERJEE, PARESH PANCHAL, AJITKUMAR SHUKLA and RANJANA GANGRADEY

IPR/TR-375/2016 (MARCH 2016)

Performance and Capabilities of CNC Abrasive Waterjet Cutting machine on R&D works for Divertor Division

SUDHIR TRIPATHI, K. P. SINGH, NIKUNJ PATEL and S. S. KHIRWADKAR

IPR/TR-376/2016 (MARCH 2016)

Techniques to Measure Hydrogen Content in SS 304L

MANOJ KUMAR GUPTA, ABHINAV PRIYADARSHI, NAVNEET MANWAL and ZIAUDDIN KHAN

IPR/TR-377/2016 (MARCH 2016)

Commissioning of Screen Grid PowerSupply 2kV, 12A (SGPS) for Testing of Tetrode based 1.5MW stage CWRP Amplifiers



KIRIT M. PARMAR, BHAVESH R. KADIA, Y. S. S. SRINIVAS, S. V. KULKARNI and ICRH GROUP
IPR/TR-378/2016 (MARCH 2016)

E 3. Conference Presentations

National Seminar on advances in Physical and Biological Sciences, Jagiroad, Assam, India, 6-7 April 2015

Green synthesis of Iron Oxide nano-particles using Tea polyphenol
Lavita Sarma, K.K. Singh, K.C. Sarma and Mayur Kakati

Criticality in Biology: A Critical Assessment, Max-Planck Institute for the Physics of Complex Systems, Dresden, Germany, 07 April 2015

A Chimeric View of the Brain Dynamics
Gautam C Sethia

7th International Conference on the Frontiers of Plasma Physics and Technology, Cochin, Kerala, 13-17 April 2015

Shear Flows in Two Dimensional Strongly Coupled Complex Plasma: A Comparative Study using Molecular and Fluid Simulations
Akanksha Gupta, R. Ganesh and Ashwin Joy

Role of Helical Pitch of the Guiding Magnetic Field on Fluctuation and Flows in Simple Toroidal Device
Umesh Kumar, T. S. Goud, R. Ganesh, D. Raju, Y. C. Saxena

1st European Physical Society Conference on Plasma Diagnostics, Frascati, Italy, 14-16 April, 2015

Design updates of ITER broad band X-ray Survey Spectrometer
Sanjeev Varshney, Robin Barnsley, Gunter Bertschinger, Martin O Mullane, Sapna Mishra, Siddharth Kumar, Nirav Bhaliya, Philippe Bernascolle, Vinay Kumar

3rd International Workshop on Measuring Techniques for Liquid Metal Flows (MTLM 2015), Dresden, Germany, 15-17 April 2015

Current Status of R&D in Liquid Metal Diagnostics Development for Indian LLCB TBM
A. Deoghar, S. Sahu, A. Saraswat, T.S. Rao, S. Verma, A. Ranjan, A. Prajapati, V. Mehta, R. Bhattacharyay, and P. Das

10th IAEA Technical Meeting on Control, Data Acquisition and Remote Participation for Fusion Research (IAEA TM-2015), Nirma University, Ahmedabad, 20-24 April 2015

Development of an Application Software and GUI for DACS of New High Heat Flux Test Facility at IPR
Sunil Belsare, Samir Khirwadkar, Ritesh Sugandhi, Rajamannar Swamy, Yashashri Patil, Kedar Bhope, Tushar Patel, Prakash Mokaria and Kalpesh Galodiya

Preliminary Design of Interlock and Safety system for Indian Test Facility of Diagnostic Neutral Beam.
Himanshu Tyagi, Jignesh Soni, Ratnakar Yadav, Mainak Bandyopadhyay, Chandramouli Rotti, Gourab Bansal, Agrajit Gahlaut, Jaydeep Joshi, Rambilas Prasad, Deepak Parmar, Kaushal Pandya, Arun Chakraborty

Overview of all the Data Acquisition and Control Systems developed For Indian Negative Neutral Beam Development Program
Jignesh Soni, Ratnakar Yadav, Himanshu Tyagi, Agrajit Gahlaut, Gourab Bansal, Mainak Bandyopadhyay, K. G. Paramar, Kaushal Pandya, V. Mahesh, Deepak Parmar, Chandramouli Rotti, Sejal Shah, Hiren Mistri and Arun Chakraborty

Upgradation of ROBIN Data Acquisition & Control System with integration of Extraction and Acceleration Power Supply System
Ratnakar Kumar Yadav, Jignesh Soni, Himanshu Tyagi, Agrajit Gahlaut, V. Mahesh, Jignesh Bhagora, Hiren Mistri, Kratik Patel, Kanu Parmar, Bhavesh Prajapati, Gaurab Bansal, Kaushal Pandya, Mainak Bandyopadhyay and Arun Chakraborty

Communication Methods for Siemens S7-300 PLC with Real Time PXI Controller

Rasesh Dave, Aruna Thakar, Hitesh Dhola, Sandip Gajjar, N. P. Singh, Darshan Parmar, Amit Patel, Bhavin Raval, Dishang Upadhyay, Kush Mehta, Niranjani Goswami, Vikrant Gupta and Ujjwal Baruah

Design of RF AGC scheme for improving Dynamic range of multichannel ECE radiometer in SST-1 Tokamak

Dharmendra Kumar, Varsha Siju, and S.K.Pathak

GPIB based Instrumentation and control system for ADITYA Thomson Scattering Diagnostic
Kiran Patel, Vishal Pillai, Neha Singh, Vishnu Chaudhary, Jinto Thomas, and Ajai Kumar

Overview of Instrumentation and data acquisition systems of cryogenics sub-systems of SST-1

D. Sonara, R. Panchal, R. Patel, G. Mehesuriya, P. Panchal, H. Nimavat, V.L. Tanna, and S. Pradhan

CO2 Laser Power Controller System

Narendra Patel, Chhaya Chavda, Ravi A V Kumar, and K K Mohandas

FPGA Based Phase Detection Technique for Electron Density Measurement in SST-1 Tokamak.
Pramila, Hitesh Mandaliya, Rachana Rajpal, Rajwinder Kaur, and R. Jha

SST-1 Central Control Infrastructure: An Overview
Jasraj R Dhongde, H. Gulati, A. Kumar, H. Masand, K. Patel, H. Chudasama, K. Mahajan, M. Bhandarkar and S. Pradhan

Current status and upgrade plan for Networking System of Steady State Superconducting Tokamak SST-1

Hitesh K Gulati, A. Kumar, K. Patel, H. Masand, J. Dhongde, K. Mahajan, M. Bhandarkar, H. Chudasama and S. Pradhan

Design and Architecture of SST-1 basic plasma control system

Kirit Patel, J. Dhongde, D. Raju, K. Mahajan, H. Chudasama, H. Gulati, A. Chauhan, H. Masand, M. Bhandarkar, S. Pradhan

Local Control Unit (LCU) for ITER-India Gyrotron Test Facility (IIGTF)

Vipal Rathod, Ronak Shah, Deepak Mandge, Rajvi Parmar and S. L.Rao

High speed hydrogen pellet monitoring and data acquisition in SPINS

Samiran Shanti Mukherjee, Jyotishankar Mishra, Ranjana Gangradey, Pramit Dutta, Naveen Rastogi, Paresh Panchal, Pratik Nayak, Jyoti Agarwal, Pawan Bairagi, Haresh Patel, Hardik Sharma

PXIe based Data Acquisition and Control (DAC) system for RF-ICRH system

Manoj Singh, HM Jadav, Sunil Kumar, Srinivas YSS, SV Kulkarni and RF-ICRH group

Data Acquisition System for SMARTEX-C

Yogesh Govind Yeole, Lavkesh Lachhvani, Manu Bajpai, Surendrasingh Rathod, Abhijeet Kumar, K. Sathyanarayana, Sambaran Pahari and Prabal Chattopadhyay

Universal Interface on Zynq SoC with CAN, RS-232, Ethernet and AXI GPIO for Instrumentation & Control

Abhijeet Kumar, Rachana Rajpal, Harshad Pujara, Hitesh Mandaliya, Praveenlal Edappala

PXI based Data Acquisition and Control system for ECRH systems on SST-1 and Aditya tokamak

Jatinkumar Patel, H. Patel, P. Dhorajiya, D. Purohit, N. Rajanbabu, B. K. Shukla

Present Status and Future Plan for SST-1 Real Time Network

Kirti Mahajan, H. Gulati, K. Patel, H. Masand, A. Kumar, J. Dhongde, M. Bhandarkar, H. Chudasama and S. Pradhan

Use of EPICS and Python Technology for Development of a Computational Toolkit for High Heat Flux Testing of Plasma Facing Components
R. Sugandhi, R. Swamy and S. Khirwadkar

Performance analysis and optimization of Gigabit Ethernet Network for I&C interfacing at High Heat Flux Test Facility

R. Sugandhi, T. Patel and S. Khirwadkar



Process Automation System for Integration and Operation of Large Volume Plasma Device

P. K. Srivastava, Ritesh Sugandhi, A.K.Sanyasi, Prabhakar Srivastava, L. M. Awasthi, R. Jha, S. K. Mattoo and P. K. Kaw

Overview of Time Synchronization System of Steady State Superconducting Tokamak SST-1

Aveg Kumar, Harish Masand, Jasraj Dhongde, Kirit Patel, Kirti Mahajan, Hitesh Gulati, Manisha Bhandarkar, Hitesh Chudasama and Subrata Pradhan

Progress in XRCS Survey Plant Instrumentation and Control Design for ITER

Sanjeev Varshney, Shivakant Jha, Stefan Simrock, Robin Barnsley, Vincent Martin, Sapna Mishra, Shreyas Patel, Vinay Kumar

Plasma Control Systems in Aditya Upgrade Tokamak

R. L. Tanna, V. K. Panchal, C. Chavda, N. C. Patel, C. N. Gupta, Kunal Shah, M.N. Makawana, K. A. Jadeja, Kaushal Patel, S. B. Bhatt, Bharat Arambhadiya, Kiran Patel, M. B. Kalal, Harshita Raj, J. Ghosh, P. K. Chattopadhyay, Y. C. Saxena and Aditya-U Team

Controlling Runaway Electrons and Plasma Disruptions using novel techniques in Tokamak ADITYA

J. Ghosh, R.L. Tanna, P.K. Chattopadhyay, Pravesh Dhyani, Harshita Raj, Jayesh Raval, Shishir Purohit, S. Joisa, C.V.S. Rao, V.K. Panchal, D. Raju, K.A. Jadeja, Kaushal Patel, S.B. Bhatt, C.N. Gupta, Chhaya Chavda, S.V. Kulkarni, B.K. Shukla, Praveenlal E.V, A. Amardas, P.K. Atrey, U. Nagora, R. Manchanda, N. Ramaiya, Nirali Virani, M. B. Chowdhuri, S. K. Jha, R. Jha, A. Sen, Y. C. Saxena, D. Bora and the ADITYA Team

Automation of Aditya Tokamak Plasma Position Control DC Power Supply

Bharat Arambhadiya, J. Ghosh, Rakesh Tanna, Harshita, Praveenlal Edappala, Rachana Rajpal and Aditya team

Multi-Channel Control Circuit for Real-Time Control of Events in Aditya Tokamak

Praveenlal Edappala, Rachana Rajpal, J. Ghosh, R. L. Tanna, P K Chattopadhyay, R Jha and Aditya Team

Massive Data Transfer Techniques between Real Time Controller and Host System

Rashmi S. Joshi, Keena R. Kalaria and Suryakant B. Gupta

Design and Development of Data Acquisition and Control System for 45.6 MHz, 100kW ICRH system using EPICS and MODBUS/TCP

Ramesh Joshi, H M Jadav, Sunil Kumar, Srinivas Y.S.S. and S.V. Kulkarni

Archiving and retrieval of experimental data using SAN based centralized storage system for SST-1

Manisha Bhandarkar, Harish Masand, Aveg Kumar, Kirit Patel, Jasraj Dhongde, Hitesh Gulati, Kirti Mahajan, Hitesh Chudasama and Subrata Pradhan.

Design, architecture and operational experience of Machine Control System (MCS) of SST-1

Harish Masand, Aveg Kumar, M. Bhandarkar, K. Mahajan, H. Gulati, J. Dhongde, K. Patel, H. Chudasama and S. Pradhan

Design, Development and Testing of Real Time Control and Data Acquisition System for R&D ICH & CD Source

Kumar Rajnish, Dipal Son, Sriprakash Verma, Hriday Patel, Rajesh Trivedi, Raghuraj Singh, Manoj Patel, Aparajita Mukherjee and KeyurMakadia

Development of data acquisition and control system for ICH & CD transmission line components test facility

Manoj Patel, Akhil Jha, Nidhi Patel, JVS Hari, Kumar Rajnish, Dipal Soni, SriprakashVerma, Hriday Patel, Rajesh Trivedi, Aparajita Mukherjee and ICH&CD group

Process Control Design of ITER Heat Rejection System

Hiren Patel, A.G.A. Kumar, D.K. Gupta, N. Patel, J. Dangi, G. Gohil, L. Sharma, M. Jadhav, F. Somboli, S. Ployhar and L.Teodoros

International Conference on Emerging Trends in Technology, Science and Upcoming Research in Computer Science, DAVIM, Faridabad, 25 April 2015

Investigation of anisotropic strain induced in Ti thin film grown on pattern substrate
B. Rajagopalan, G. Meenakshi, M. Ranjan

21st Topical Conference on RF Power in Plasmas, Lake Arrowhead, California, USA, 27-29 April 2015

Recent Pre-ionization, Wall Conditioning, Second Harmonic Heating and Disruption Mitigation Experiments using 1MW ICRH System on Tokamak ADITYA

S.V. Kulkarni, Sunil Kumar, Srinivas Y.S.S., Atul Varia, Ramesh Joshi, H.M. Jadav, Paihar Manoj, B.R. Kadia, Kirit Parmar, Gayatri Ashok, D. Rathi, Rakesh Tanna, Joydeep Ghosh, Kumar Jadeja, S.B. Bhatt, Kumar Ajay, Snehalata Gupta, Umesh Dhobi, S.K. Pathak, Praveenlal, Jayesh Raval, Manoj Gupta, Santosh Pandya, Jinto Thomas, R. Jha, Amita Das, D. Bora and Aditya Team

Development of Mismatch Transmission Line (MMTL) system for ICH&CD test rig
P Ajesh, Akhil Jha, Rohit Anand, JVS Harikrishina, Rajesh Trivedi, Aparajita Mukherjee

Development of travelling wave resonator based test bed for high power transmission line component testing

Akhil Jha, JVS Harikrishina, P Ajesh, Rohit Anand, Rajesh Trivedi, Aparajita Mukherjee

INSPIRE Internship Science Camp-2015, Department of Science and Technology, Amreli, Gujarat, 5-9 May 2015

Energy and Nuclear Fusion: Challenges from Materials
P. A. Rayjada

DEMO Program Workshop (DPW-3), Hefei, China, 11-15 May 2015

Design of LLCB TBM towards the Indian DEMO Reactor
Paritosh Chaudhuri

15th International Conference on Plasma-Facing Materials and Components for Fusion Applications, Aix-En-Provence, France, 18-22 May 2015

Development of a segmented plasma torch assisted high heat flux system and observation of some exotic micro-structures upon exposure of tungsten targets

N. Aomoa, Trinayan Sarmah, Puspallata Sah, J. Ghosh, M. Kakati and G. Temmermann

Experiments and Modelling of Temperature Dependence of Erosion of Tungsten

P.N. Maya, G. De Temmerman and S.P. Deshpande

Multiscale Modelling of Neutron Induced Radiation Damage in Tungsten

S.P. Deshpande, P.N. Maya, P.V. Subhash, P. Nandi, M. Warriar, P.M. Raole and S. Khirwadkar

High heat flux testing of Divertor Plasma facing materials and components using HHF test facility at IPR

Yashashri Patil, S. S. Khirwadkar, Sunil Belsare, Rajamannar Swamy, Sudhir Tripathi, Kedar Bhope, and Shailesh Kanpara

28th ITPA Topical Group on Diagnostics Meeting, NIFS, Japan, 19-22 May 2015

Summary report of Passive Spectroscopy -Specialist Working Group

Sanjeev Varshney, Robin Banrsley

IN-DA Progress on ITER XRCS-Edge and Survey Spectrometers

Sanjeev Varshney et al.

IN-DA Progress on ITER ECE Diagnostic System
Hitesh Pandya, Suman Danani, Ravinder Kumar, Siddharth Kumar, Shrishail, Sajal, Kaushal Joshi, Vinay Kumar, and Victor Udintsev

IN-DA Progress on Upper Port #09

Siddharth Kumar, Shrishail Padasalagi, Sanjeev Varshney, Shrichand Jhakar, Mitul Abhangi, Vinay Kumar, Victor Udintsev, Thibaud Giocomin



International Workshop on Models and Data for Plasma-Material Interaction in Fusion Devices, Aix-Marseille University, Marseille, France, 25-27 May 2015

PlasmaWall Interactions in Presence of Fusion Neutrons: Modelling and Ion Irradiation Experiments

P.N. Maya, S.P. Deshpande, P.V. Subhash, P. Nandi, M. Warriar, V. Sai Krishna, P.M. Raole and S. Khirwadkar

International Conference on Industrial Instrumentation and Control (ICIC-2015), College of Engineering Pune (COEP), Pune, 28-30 May 2015

High Speed Analog Fiber Optical Transmission link Based on Voltage to Frequency Converter technique for ITER-India Gyrotron Test Facility
Vipal Rathod, Rajvi Parmar, Deepak Mandge, Ronak Shah and S. L.Rao

20th IEEE Pulsed Power Conference (PPC) and the 26th IEEE Symposium on Fusion Engineering (SOFE), Austin, Texas, USA, 31 May-04 June 2015

Effects of Mechanical loads on ITER XRCS-SURVEY sight-tube

Siddharth Kumar, Sanjeev Varshney, Kunal Bhatt, Nirav Bhaliya, Shrishail Padasalagi, Sapna Mishra, P. V. Subhash, Vinay Kumar, Robin Bansley, Philippe Bernascolle, Jean-Marc Drevon

Visual Inspection and Motion Control for Invessel Tile Servoing Tasks in a Tokamak Vessel

V. Balakrishnan, M. Senapathi and J. Srinivas

Physics and Engineering Issues Associated with Increasing Beam Energy on the DIII-D Neutral Beam System

B.J. Crowley, J. Rauch, S. K. Sharma, B. Choksi, J. T. Scoville

ECRH Assisted Plasma Experiments on Tokamaks SST-1 and Aditya

B. K. Shukla, D. Bora, R. Jha, S. Pradhan, Joydeep Ghosh, C. N. Gupta, J. Patel, Rajan Babu, Harshida

Patel, Pragnesh Dhorajia, R. L. Tanna, V. Tanna, P. K. Atrey, S. Joisa, S. B. Bhatt, Dharmesh Purohit, P. K. Chattopadhyay, D. Raju, Paresh Patel, R. Manchanda, Manoj Gupta, Aditya Team and SST-1 Team

Concurrent Construction on Evolving Design: ITER-India Experience and Lessons for Future

S. P. Deshpande, I. Bandyopadhyay, U. K. Baruah, A. K. Bhardwaj, A. K. Chakraborty, A. Kumar, V. Kumar, A. Mukherjee, S. B. Padasalagi, H. A. Pathak, S. L. Rao, B. Sarkar

Lessons Learned During the Procurement of the ITER Steady State Electrical Network Components by the US Domestic Agency

C. Neumeyer, J. Dellas, J. Hourtoule, S. Nair, A. Das

Mechanical Arrangement for Assembly of Iws Blocks to Iter Vacuum Vessel

G.S. Phull, H. Pathak, J. Raval

Fabrication of Vacuum Vessel with Detachable Top Lid Configuration for Indian Test Facility (INTF)

J. Joshi, A. Yadav, D. K. Singh, H. Patel, M. Girish, M. Khan, C. Rotti, M. Bandyopadhyay, A. Chakraborty

Innovation and Implementation of Welding Processes for ITER Cryostat

V.N. Joshi, M.R. Patel, R. Prajapati, A. Bhardwaj, G. Gupta, A. Bhattachary, J. Bhavsar, A. Palaliya, M. Jindal, M. Pandey, S. Jha, G. Jogi, H. Desai, J. Jose, J. Dutt, V. More

Instrumentation and Control System Architecture for SST-1 Neutral Beam Injector

L.K. Bansal

Design and Development of Millimeter Wave Band Pass Filter

P.K. Atrey, D. Pujara, S. Mukherjee

Manufacturing and Assembly of IWS Support Rib and Lower Bracket for ITER Vacuum Vessel

R. Laad, Y. Sarvaiya, H. A. Pathak, J. R. Raval, C. H. Choi, P. Suresh

The Indian Test Facility (INTF) for Neutral Beams, a Status Update

A.K. Chakraborty, U.K. Baruah, M. Bandyopadhyay, G. Bansal, J. Bhagora, M. Bhuyan, A. Gahlaut, J. Joshi, K. Joshi, V. Mahesh, H. Mistry, M.V. Nagaraju, R. Pandey, K. Pandya, D. Parmar, K.G. Parmar, H. Patel, M. Patel, K. Patel, S. Pillai, B. Prajapati, G. Roopesh, C. Rotti, S. Shah, D. Sharma, H. Shishangiya, D. Singh, N.P. Singh, J. Soni, D. Sudhir, H. Tyagi, M. Vishnudev, A. Yadav, R. Yadav

Status of Diagnostics Development & Integration in Indian Test Facility (INTF) for Iter-DNB (Diagnostic Neutral Beam)

D.S. Kumar, M. Bandhopadhyay, M. Bhuyan, J. Soni, H. Tyagi, S. Pillai, J. Joshi, A. Yadav, C.M. Rotti, D. Sharma, R. Yadav, J. Bhagora, R. Pandey, D. Parmar, H. Patel, V. Nagaraju, D. Singh, M. Patel, G. Bansal, K. Pandya, A. Chakraborty

Indian Single Pellet Injection System for Plasma Fuelling Studies

R. Gangradey, J.S. Mishra, S. Mukherjee, P. Panchal, P. Nayak, P. Bairagi, H. Sharma, H. Patel, P. Dutta, N. Rastogi, J. Agarwal

Indigenously Developed Large Pumping Speed Cryoadsorption Cryopump

R. Gangradey, S. Mukherjee, J. Agarwal, M. Stephen, P. Panchal, P. Nayak, S. Kasthuriengan, S. Udgate, V.S. Tripathi, H. Patel, J.S. Mishra, V. Lambade, P. Bairagi, V. Kumar, R. Sayani

Progress in the Design and Procurement of the High Voltage Power Supplies for Iter Ec System

T. Gassmann, F. Albajar, F. Arnold, M. Bader, T. Bonicelli, C. Darbos, H. Decamps, K. Hayashi, M. Henderson, K. Sakamoto, D. Parmar, N. Singh

Prototype High Voltage Bushing: Configuration to Its Operational Validation

S. Shah, D. Sharma, D. Parmar, H. Tyagi, A. Gahlaut, J. Soni, J. Joshi, K. Pandya, K. Joshi, M. Bandyopadhyay, C. Rotti, A. Chakraborty

Indigenous Manufacturing Realization of Twin Source and Its Auxiliary Systems

R. Pandey, M. Bandyopadhyay

Design & Development of Electrical System for Twin Source

D. Parmar, V. Mahesh

Development of Prototype Elements for Beam Line Components for ITER Diagnostic Neutral Beam and Indian Test Facility

H. Patel, C. Rotti, N. Panda, N. Kanoongo, K. Balasubramanian, A. Chakraborty

Recent High Current Plasma Discharges Operations with Booster Power supply assisted Vertical Magnetic Field in Aditya Tokamak

C.N. Gupta, Kunal Shah, M N Makwana, R L Tanna and J Ghosh

Indian Test Facility (INTF) – a Status Update

A Chakraborty, U Baruah, M Bandyopadhyay, G Bansal, J Bhagora, M Bhuyan, S Dass, A Gahlaut, J Joshi, V Mahesh, H Mistry, M V Nagaraju, R Pandey, K Pandya, D Parmar, K Parmar, H Patel, M Patel, K Patel, S Pillai, B Prajapati, G Roopesh, C Rotti, S Shah, D Sharma, H Shishangiya, D Singh, N P Singh, J Soni, H Tyagi, M Vishnudev, A Yadav, R Yadav

Status of diagnostic development & integration in Indian Test Facility (INTF) for ITER-DNB (DIAGNOSTIC NEUTRAL BEAM)

Dass Sudhir Kumar, M. Badyopadhyay, M. Bhuyan, J. Soni, H. Tyagi, S. Pillai, J. Joshi, A. Yadav, C. Rotti, D. Sharma, R. Yadav, J. Bhagora, S. Shah, R. Pandey, D. Parmar, H. Patel, G. Roopesh, V. Nagaraju, D. Singh, M. Patel, G. Bansal, K. Pandya, A. Gahlaut, K. Parmar, and A. Chakraborty

Manufacturing Experience of Beam Dump for Spider Facility

H. Patel, C. Rotti, M.V. Nagaraju, A. Chakraborty, B. Schunke, J. Chareyre, D. Boilson, L. Svensson, M. Dalla Palma, P. Zaccaria, P. Roberto, E. Pfaff, J. Schafer, C. Eckardt

21st ITPA Meeting on SOL/Divertor Physics, Princeton Plasma Physics Laboratory, Princeton, USA, 09-12 June 2015

Plasma Facing Component Development and Testing at IPR

Samir Khirwadkar



5th Asia Pacific Transport Working Group (APTWG) International Conference, Dalian, China, 9-12 June, 2015

Edge turbulence and SOL flow in the electron cyclotron waves over-driven Ohmic plasmas in QUEST

Santanu Banerjee, H. Zushi, N. Nishino, K. Mishra, T. Onchi, A. Kuzmin, K. Hanada, Y. Nagashima, K. Nakamura, H. Idei, M. Hasegawa, A. Fujisawa and the QUEST Team

Plasmas Surfaces and Thin Films: Early Career Researchers Meeting, Loughborough University, Loughborough, UK, 17 June 2015

ZnO:Al Thin Film Deposition by Magnetron Co-Sputtering

Sagar Agrawal, Divya Dileep, Priyanka Marathe, Ramkrishna Rane, Subroto Mukherjee

42nd European Physical Society (EPS) Conference, Lisbon, Portugal, 22-26 June 2015

Trapped Energetic Electrons Driven Lower Hybrid Turbulence in Slab Plasma of LVPD

L. M. Awasthi, A. K. Sanyasi, S. K. Mattoo, P. K. Srivastava, S. K. Singh, R. Singh and P. K. Kaw

Cryogenic Engineering Conference and International Cryogenic Material Conference (CEC/ICMC-2015), Tucson, Arizona, USA, 28 June - 2 July 2015

Value Engineering in System of Cryoline and Cryodistribution for ITER: In-kind Contribution from India

B. Sarkar, N. Shah, H. Vaghela, R. Bhattacharya, K. Choukekar and P. Patel

Load specification and embedded plate definition for the ITER cryoline system

S. Badgajar, L. Benkheira, M. Chalifour, A. Forgeas, N. Shah, H. Vaghela and B. Sarkar

Design realization towards the qualification test of ITER cold circulator

R. Bhattacharya, B. Sarkar, H. Vaghela, P. Patel, J. Das, S. Muralidhara and V. Shukla

10th ITER Neutronics Meeting, ITER Organization, Cadarache, 30 June - 3 July 2015

Neutronics and Radiation Waste Analysis for XRCS Survey Sight Tube

P.V. Subhash, Gunjan Indauliya, T Sai Chaitanya, S. Jakhar, Sanjeev Varshney, Siddharth Kumar, Raja Krishna K, Nirav Bhaliya, Robin Barnsley, Bernascolle Philippe, P. Shrishail, Vinay Kumar

1st QIRT-ASIA-2015 Conference on Quantitative Infrared Thermography, Mamallapuram, Tamil Nadu, 7-10 July 2015

Transient infrared thermography testing of Divertor Plasma Facing Components for Nuclear Fusion application

Yashashri Patil, S.S. Khirwadkar, T. Patel, N. Patel, P. Mokaria.

ASME 2015 Pressure Vessels & Piping Conference (PVP 2015), Boston, Massachusetts, USA, 19-23 July 2015

Design Development of a Vacuum Vessel with Detachable Top Lid Configuration

J. Joshi, A. Yadav, R. Gangadharan, M. Bandyopadhyay, C. Rotti

PSSI-Plasma Scholars Colloquium, Jadavpur University, Kolkata, 6-7 August 2015

Influence of Arc Current on the Morphology of Cobalt Based Nanostructures using Thermal Plasma

Prachi B. Orpe, and C. Balasubramanian

Magnetic field effect on hysteresis dynamics and low frequency self-oscillation in reflex plasma source

R. Rane, S. Mukherjee, A.N. Sekhar Iyengar

Study of Dynamic Behavior inside Magnetized DC Plasma Torch

Vidhi Goyal and G. Ravi

A New Linear Plasma Device for Study of Pure Electron Vortices in the Context of Electron Magneto Hydrodynamics

Garima Joshi, G. Ravi and S. Mukherjee

Comparative Study of Magnetic Properties of Iron Oxide Nanoparticles Prepared by Supersonic Nozzle Expansion Plasma Method and Green Chemical Method

Lavita Sarma, Trinayan Sarmah, N. Aomoa, Sidananda Sarma and Mayur Kakati

Study of Turbulent Transport in the Background of ETG Turbulence

Prabhakar Srivastava

National Conference on Thermo-mechanical processing of Steels & 5th Gleeble User Workshop India (GUWI-2015), NML, Jamshedpur, 6-7 August 2015

Overview of Experimental Activities using Gleeble 3800 system at IPR

Alpesh Patel, Shailesh Kanpara, K.P.Singh, Sudhir Tripathi, Mayur Mehta, Kalpesh Galodiya, S.S.Khirwadkar

International Conference on Contemporary Advances of Science and Technology, (IC-CAST – 2015), Banaras Hindu University, Varanasi, India, 7-9 August 2015

An Investigation of Electro-Magnetic pulse welding

Subhanarayan Sahoo, Rajesh Kumar, Saurabh Kumar, Rahul Koshti, A. Shyam

4th International Conference on Advances in Computing, Communications and Informatics (ICACCI 2015), Student Research Symposium, Kerala, India, 10-13 August 2015

Interfacing ICRH DAC System with WEB

Ramesh Joshi, H.M. Jadav and S.V. Kulkarni

Integration of USB based Multifunction Data Acquisition Module with ICRH DAC

Anirudh Mali, Ramesh Joshi, H.M. Jadav and S.V. Kulkarni

16th International Conference on Ion Sources, Brookhaven National Laboratory, Manhattan, New York, USA, 23-28 August 2015

Overview of Ion Source Characterization Diagnostics in Indian Test Facility (INTF)

M. Badyopadhyay, Dass Sudhir, M. Bhuyan, J. Soni, H. Tyagi, J. Joshi, A. Yadav, C. Rotti, Deepak Parmar, H. Patel, S. Pillai and A. Chakraborty

Physics-Electrical Hybrid Model for Real Time Impedance Matching and Remote Plasma Characterization in RF Plasma Sources

Dass Sudhir, M. Bandyopadhyay, A. Chakraborty

16th International Topical Meeting on Nuclear Reactor Thermalhydraulics (NURETH-16), Chicago, 30 August- 4 September 2015

RELAP/SCDAP/MOD4.0 modification for transient accident scenario of Test Blanket Modules involving helium flows into heavy liquid metal

M. Perez, J. Freixa, E. Mas de les Valls, T. Sandeep, V. Chaudhari

31st European Conference on Surface Science (ECOSS-31), Barcelona, Spain, 31 August - 4 September 2015

Study on Effect of Corrosion on Outgassing of ITER Vacuum Vessel In-Wall Shielding Materials

A Maheshwari, H A Pathak, B K Mehta, R Laad, G S Phull, M S Shaikh, U K Dethle, S Dani

14th IAEA Technical Meeting on Energetic Particles in Magnetic Confinement Systems, IAEA Headquarters, Vienna, Austria, 1-4 September 2015

Diagnosis of Mirror Trapped Particles and Excitation of Energetic particle (EP) Driven Modes in LVPD

A. K. Sanyasi, L. M. Awasthi, P. K. Srivastava, S. K. Mattoo and P. K. Kaw

Symposium on Water Chemistry and Corrosion in Nuclear Power Plants in Asia – 2015, Anupuram, IGCAR, India, 2-4 September 2015

Evaluation of Plasma Coated Carbon Steel to Resist Flow Accelerated Corrosion

P. Madasamy, J. Alphonsa, J. Ghanshyam, S. Mukherjee, M. Mukunthan, P. Chandramohan, T.V. Krishna Mohan, E. Natarajan and S. Velmurugan



2nd Research Coordination Meeting of IAEA's Coordinated Research Project on Plasma-Wall Interaction for Irradiated Tungsten and Tungsten Alloys in Fusion Devices, Seoul National University, Seoul, Republic of Korea, 8-11 September 2015

Radiation damage of Heavy ions and H irradiated Tungsten - Some Experimental Results

P. M. Raole, P. N. Maya, Shishir Deshpande, S. Khirwadkar, P. A. Rayjada, C. Dube, Saikrishna, C. Jariwala, S. Kanpara, M. Mehta, Rajguru, C. David, B. K. Panigrahi, P. Kularia, Saif Khan, Ravi Gundakaram, D. Datta,

International Conference on Applications of Lasers in Manufacturing (CALM-2015), New Delhi, 9-11 September 2015

Laser Shock Peening of Stainless Steels using Different Sacrificial Layers

Pardhu Y, Venkateswarlu P, N. Ravi, R.K. Buddu, Koteswara Rao R, Prem Kiran P, KBS Rao

Simulation of Hybrid Laser-TIG Welding Process: Combining Heat Flux Models and FEM Analysis

S. Akella, V. Harinadh, R.K. Buddu

Study of Laser Cladding Process Parameters Optimization using Copper Powder on SS316 Substrate by Simulation and Validation

Ravi Parekh, Ramesh Kumar Buddu, R. Patel

Simulation of Hybrid Laser-TIG Welding Process: Thermal Modelling of SS316L by FEM

S. Akella, V. Harinadh, R.K. Buddu

4th International Workshop on Diagnostics and Simulation of Dusty Plasmas, Kiel, 9-11 September 2015

Kolmogorov Flow in 2D Strongly Coupled Dusty Plasma: A Comparative Study using Molecular Dynamics and Fluid Simulations

Akanksha Gupta, Rajaraman Ganesh and Ashwin Joy

17th International Symposium on Electromagnetic Fields, Valencia, Spain, 10-12 September 2015

Multi-Secondary Transformer Analysis Using Finite Element Method

Amit Patel, Gaurav Srivastava, N. P. Singh, Ujjwal Baruah, Dishang Upadhyay

18th International Workshop on Ceramic Breeder Blanket Interactions (CBBI), Jeju Island, Korea, 10-12 September 2015

Status of Development of Lithium Ceramic Breeder Materials at IPR, India

Paritosh Chaudhuri

Preliminary Analysis and Measurement of Mechanical & Thermo-Mechanical Properties of Li_2TiO_3 Pebbles

Paritosh Chaudhuri

12th International Symposium on Fusion Nuclear Technology (ISFNT-12), Jeju Island, Korea, 14-18 September 2015

Overview of LLCB TBM Design and R & D Activities in India

E. Rajendra Kumar, K. N. Vyas, T. Jaykumar

Thermal-hydraulics of LLCB TBM under different ITER operational conditions

Paritosh Chaudhuri

Engineering design and analysis of Indian LLCB TBM set

S. Ranjith Kumar

Accident analyses of selected postulated events for safety assessment of Indian LLCB TBS in ITER

K T Sandeep, Vilas Chaudhari

Validation and implementation of sandwich structure bottom plate to rib weld joint in the base section of ITER Cryostat

Rajnikant Prajapati, Anil K. Bhardwaj, Girish Gupta, Vaibhav Joshi, Mitul Patel, Jagrut Bhavsar, Vipul More, Mukesh Jindal, Avik Bhattacharya, Gaurav Jogi, Amit Palaliya, Saroj Jha, Manish Pandey, Pandurang Jadhav, Hemal Desai

9th International Conference on Inertial Fusion Sciences and Applications (IFSA2015), Bellevue,

Washington, USA, 20-25 September 2015

Anomalous Inverse Bremsstrahlung Heating of Laser-Driven Plasmas
Mrityunjay Kundu

1st IAEA Technical Meeting (TM) on Divertor Concepts, Vienna, Austria. 29 September - 3 October 2015

Performance of ITER-like divertor targets under non-uniform and transient thermal loads Samir Khirwadkar, Sunil Belsare, Rajamannar Swamy, Yashashri Patil, Kedar Bhope, Vinay Menon, Deepu Krishnan, Alpesh Patel, Shailesh Kanpara, Sudhir Tripathi

Performance of ITER-like divertor targets under non-uniform and transient thermal loads
S.S.Khirwadkar

32nd DAE Safety & Occupational Health Professionals Meet, Raja Ramanna Centre for Advanced Technology, Indore, 5-7 October 2015

Advanced Safety Measures Implemented in Negative Neutral Beam (NNB) HVPS Facility at IPR

A. Gahlaut, V. Mahesh, A.K. Chakraborty, K.G Parmar, B.K. Prajapati, D.V. Modi, D. Parmar, H. Shishangiya, M.N. Vishnudev, J. Soni, G. Bansal, M. Bhandopadhyay, R.K. Yadav, K. Pandya, J. Bhagora, H. Tyagi and H. Mistri

Implementation of Safety Measures of New High Heat Flux Test Facility at IPR

Sunil Belsare, Rajamannar Swamy, Tushar Patel, Samir Khirwadkar, Devendra Modi, Yashashri Patil, Kedar Bhope and Prakash Mokaria

Safety and Environment (S&E) Aspects of Tokamak-Type Fusion Power Reactors - An Overview

Bharat Doshi and D. Chenna Reddy

Testing and Preventive Maintenance of Electrical Power Systems in Substation for Safety and Reliability

Chandra Kishor Gupta

Safety Aspects in Helium Recovery System at IPR
Samiran Shanti Mukherjee, D.V. Modi, Ranjana Gangradey, P. Panchal, J. S. Mishra, D. Tripathi, S. Kasthuriangan, Jyoti Agarwal and Pratik Nayak

Study of the Safety Criteria and the Radiation Limit in Microwave Coal Gasification Experiments
Vishal Jain

Safety Management System Implementation at IPR
D.V. Modi and D. Chenna Reddy

National Symposium on Acoustics (NSA-2015), CSIR-National Institute of Oceanography, Dona Paula, Goa, 7-9 October 2015

Acoustic Emission Studies on Weld Defects under Constant Load with Mechanical Jig

S.V. Ranganayakulu, P.V. Sastry, J. Siva Raju, B. Ramesh Kumar

12th International Surface Engineering, Paints and Coatings Symposium & Expo 2015, India Expo Centre, Greater Noida, Delhi, 7-9 October 2015

Microstructural Investigation of Plasma Processed Aluminized Coatings for High Temperature Applications

Nirav I. Jamnapara

DAE-BRNS Workshop on Monte Carlo Neutron transport Code (MONC), BARC, Mumbai, 8-9 October 2015

Fusion Neutronics Activities in TBM Neutronics Section at IPR

Deepak Aggarwal and TBM Neutronics Team

17th International Conference on Fusion Reactor Materials (ICFRM-17), Aachen, Germany, 11-16 October 2015

Deposition of Er₂O₃ Coating and its Structural, Microstructural, Electrical and Optical Studies

P A Rayjada, Amit Sircar, N P Vaghela, R Rahman, N L Chauhan, M Ranjan, M Bhatnagar, L M Manocha, and P M Raole



2nd Bilateral Indo-Italy Workshop Nanoscale Excitations in Emergent Material (NEEM-2015), Rome, Italy, 12-14 October 2015

Overview of fusion materials and technologies developments at IPR for Divertor & Firstwall Applications
S.S.Khirwadkar

24th International Conference on Magnet Technology, Seoul, S. Korea, 18-23 October 2015

Design and Fabrication of Special Purpose Winding Machine for Non-coplanar ELM Control Coils of JET
Mahesh Ghate, Subrata Pradhan, Madhu Patel, Dhaval Bhavsar, Kirit Vasava

Technology Developments towards ELM Coils Manufacturing Appropriate for Tokamaks
Subrata Pradhan, Mahesh Ghate, Priyanka Brahmabhatt, Nitish Kumar, Kedar Bhope, Dhaval Bhavsar, Swarup Udgata, Madhu Patel

Preliminary design of central solenoid for SST-2 and Demo
U. Prasad, R. Srinivasan, S. Pradhan, A. N. Sharma, V. Menon, C. Danani, D. Garg, N. Rastogi, S. Khirwarker, R. Kumar, P. K. Kaw, S. Deshpande, A. Das and D. Bora

18th International Conference on Radiation Effects in Insulators (REI-18), Jaipur, Rajasthan, India, 26-31 October 2015

In-situ Volumetric Sputtering Yield Measurements of BNSiO₂ Ceramic for Various Ion Energies and Incident Angles
M. Ranjan

COMSOL Conference 2015, Hyatt Regency Pune, 29-30 October 2015

Study of Circular Waveguide Window for Millimeter Wave Transmission Line
Krupali D. Donda, Ravinder Kumar, Hiteshkumar Pandya

29th Meeting of the ITPA TG on Diagnostics,

ITER-Organization, France, 2-6 November 2015

Progress update on ITER XRCS- Survey and Edge systems
Sanjeev Varshney, Siddharth Kumar, Sapna Mishra, Shivakant Jha, Subhash Puthenveetil, Kaushal Joshi, Vinay Kumar, Robin Barnsley, Philippe Bernascolle, Gunter Bertschinger, Martin O' Mullane, Shaun Huges, Stefan Simrock, Vincent Martin, Jean-Marc Drevon and Mike Walsh

IN-DA progress on ITER ECE diagnostic system (TL & receiver)
Hitesh Pandya, Suman Danani, Ravinder Kumar, Siddharth Kumar, Shrishail, Sajal, Vinay Kumar, and Victor Udintsev

IN-DA Progress on Upper Port #09
Siddharth Kumar, Shrishail Padasalagi, Sanjeev Varshney, Shrichand Jhakar, Mitul Abhangi, Shivakant Jha, Vinay Kumar, Victor Udintsev, Thibaud Giocomin, Richard O' Connor

Progress on designing Hard X-Ray Monitor for ITER (PBS 55.EE)
Santosh P. Pandya, R. Makwana, K. Assudani, G. Jagannathan, R. Barnsley and ITER-IO diagnostics Team

25th International Toki Conference (ITC-25), Ceratopia Toki, Toki-city, Gifu, Japan, 3-6 November 2015

Behavior of non-thermal electrons during ECR pre-ionization at Aditya tokamak
S. Purohit, Y. S. Joisa, J. V. Raval, M. B. Chowdhuri, B. K. Shukla, R. Manchanda, N. Ramaiya, U. C. Nagora, P. K. Atrey, R. L. Tanna, K. A. Jadeja, S. B. Bhatt, C. N. Gupta, A. Kumar, J. Ghosh and Aditya Team

57th Annual Meeting of APS Division of Plasma Physics, Savannah, Georgia, USA, 16-20 November 2015

Collisionless Microtearing Modes in Large Aspect Ratio Tokamaks with Weak Reversed Shear Configurations
Aditya Krishna Swamy, Rajaraman Ganesh, Stephan Brunner, Jan Vaclavik, and Laurent Villard

Destabilization of Trapped Electron Clouds by Embedded and Collision Generated Ions: PIC-MCC Simulations

Meghraj Sengupta and Rajaraman Ganesh

Field Line modeling of divertor footprints due to RMPs

Benjamin P. Riviere, D.M. Orlov, R.A. Moyer, S. Dutta, and T.E. Evans

Optimization of RMP Coils for ELM Control

Someswar Dutta, T.E. Evans, and D.M. Orlov

Atomic and Molecular Spectroscopic Studies of the DIII-D Neutral Beam Ion Source and Neutralizer

B. Crowley, J. Rauch, J.T. Scoville, S.K. Sharma, and B. Choksi

Simultaneous existence of Kelvin Helmholtz and Drift wave Instabilities in IMPED

P.K. Chattopadhyay, Sayak Bose, J. Ghosh, and Y.C. Saxena

Localized electron heating and downstream density rise in expanding helicon plasma

Soumen Ghosh, Kshitish Barada, Prabal Chattopadhyay, Joydeep Ghosh, and Dhiraj Bora

Interaction of plasma oscillations with a background ion density perturbation

Sayak Bose, Manjit Kaur, P.K. Chattopadhyay, J. Ghosh, and Y.C. Saxena

Physics and Engineering Design of the ITER Electron Cyclotron Emission Diagnostic

W. L. Rowan, M.E. Austin, S. Houshmandyar, P.E. Phillips, J. H. Beno, A. Ouroua, D.A. Weeks, A.E. Hubbard, J.A. Stillerman, R.E. Feder, A. Khodak, G. Taylor, H. K. Pandya, S. Danani, R. Kumar

29th National Symposium on Vacuum Technology and its Applications to Electron Beams (IVSNS-2015), Homi Bhabha Auditorium, Tata Institute of Fundamental Research, Colaba, Mumbai, 18-20 November 2015

Ultra-High Vacuum System of SMARTEX-C
Lavkesh Lachhvani, Yogesh G. Yeole, Manu Bajpai, Sambaran Pahari and Prabal K. Chattopadhyay

Testing of New Torus Shaped Vacuum Vessel of Aditya Upgrade Tokamak

K. A. Jadeja, K. M. Patel, S.B. Bhatt, N. D. Patel, K. N. Chaudhary, Kulav Rathod, K.S. Acharya, M. B. Kalal, D. S. Varia, R. L. Tanna, J. Ghosh, Y. C. Saxena and Aditya Upgrade Team

Structural Design of Limiter and Divertor for Aditya Tokamak Upgrade

K. M. Patel, Kulav Rathod, K. A. Jadeja, S. B. Bhatt, Deepti Sharma, Y. Srinivasan, D. Raju, R. L. Tanna, Joydeep Ghosh, P. K. Chattopadhyay, Y. C. Saxena and Aditya Upgrade Team

Electron gun irradiation contour for different materials on dielectric surface in vacuum

Rashmi S. Joshi and Suryakant B. Gupta

25th National Seminar & International Exhibition on Non-Destructive Evaluation (NDE-2015), Hyderabad International Convention Centre, Madhapur, Hyderabad, 26-28 November 2015

Weld defects analysis of 60 mm thick SS316L mock-ups of TIG and EB welds by Ultrasonic inspection for fusion reactor vacuum vessel applications

Ramesh Kumar Buddu, Shamsuddin Shaikh, P.M. Raole, B Sarkar

NDT studies of laser cladding defects of pure copper on SS316L for in vessel materials for fusion reactor applications

Shamsuddin Shaikh, Ramesh Kumar Buddu, P.M. Raole, B Sarkar

5th Annual Quality Conference jointly organized by ASQ LMC Ahmedabad and Institute of Management, Nirma University, Ahmedabad, 28 November 2015

Plasma Nitriding - An Eco Friendly Indigenously Developed Process for Enhancing the Life of Industrial Components, A case study of journey from laboratory to industry

J. Alphonso, G. Jhala, S. B. Gupta, S. Mukherjee

30th National Symposium on Plasma Science & Technology (Plasma-2015), Saha Institute of Nuclear Physics, Kolkata, India, 1-4 December 2015



The Modified Profile Argon Line Spectra in Two Interacting Transient Plasmas

Parthasarathi Das, Rita Paikaray, Gourishankar Sahoo, Subarta Samantaray, Joydeep Ghosh

Measurements of EOS and Resistivity of Warm Dense AI-Plasma

Aditya Nandan Savita, Sambaran Pahari, Rahulnath PP, Shashank Chaturvedi, Joydeep Ghosh, Kshitish Barada

Study of Helicon Waves in Nonuniform Plasma

Sonu Yadav, P K Chattopadhyay, Soumen Ghosh, J Ghosh

Revisiting Timing and Synchronization for Multi-module Data Acquisition System on PXle bus for Laboratory Plasma Experiments

R. Sugandhi, P. Srivastava, A. Sanyasi, Prabhakar Srivastav, L.M. Awasthi, V. Parmar, K. Makadia, I. Patel and S.Shah

Design and Development of Blumlein Generator for Nanosecond Pulse Applications.

Priyavandana J. Rathod, Anitha V.P., Naresh Kadia, and Jijo Samuel

A Scheme of Coupling of High Power Microwave to Plasma in SYMPLE

Raj Singh, Anita Vidyadhar and Rohit Shukla

Probe Induced Void in Cogenerated Dusty Plasma

Malay Mondal, Sanjib Sarkar, Abhinandan Dutta, Sabyasachi Ghosh, Shahin Nasrin, Avik Kr. Basu, Malabika Dey, Chirantan Hazra, M. Bose, and S. Mukherjee

Recent Progress on Software Operated Machine Control System for Large Volume Plasma Device

R. Sugandhi, P.K. srivastava, A.K. Sanyasi, Prabhakar Srivastav, L.M. Awasthi, V. Parmar, K. Makadia, I. Patel and S. Shah

Study of Electron and Ion Dynamics in 1D driven Vlasov-Poisson Model

Pallavi Trivedi, R. Ganesh

Validation of Goldstein-Wehner Law in Glow Discharge Plasma using Argon Gas

Prijil Mathew, Alwin Jose, P.J. Kurian, P.K. Chattopadhyay

Bounded EMHD Waves in Nonuniform Magnetic Field

Chetan R S Chauhan and Devendra Sharma

Effect of Ion Dynamics in Dispersion Relation of Whistlers

A.K. Sanyasi, D. Sharma, L.M. Awasthi, P.K. Srivastava, S. K. Mattoo, P. K. Kaw

The Validation Tests of Fusion Grade Superconductors

U. Prasad, P. Raj, P. Varmora, A. Panchal, A. N. Sharma, A. Bano, M. Ghate, Magnet Division and S. Pradhan

Parametric Study of Plasma Density & Field Profiles in Helicon Plasma Source under various operating conditions.

Pranjali Singh, Dass Sudhir, Arun Pandey, Mainak Bandyopadhyay, Arun K. Chakraborty

Study of RF Induced Breakdown of 805 MHz Pill Box Cavity at Femilab Mucool Test Area

M. R. Jana, M. Chung, A. Tollestrup, B. Freemire, A. Moretti, Y. Torun, K. Yonehara, M. Palmer and M. Leonova

Design and Development of High Voltage and High Frequency Center Tapped Transformer for HVDC Test Generator

Urmil Thaker, Kumar Saurabh, Amal S., Animesh Bhatt, U. K. Baruah

DC Current Breaking for the fast Operations Ohmic Power Supply during SST 1 Operations

C N Gupta, Kunal Shah and M N Makwana

Infrared thermography a diagnostic tool for predictive/preventive maintenance of electrical equipment in substation

Chandra Kishor Gupta & Power Distribution Division

Characterization of Lithium Titanate Ceramic using Crush Load Tests and High Resolution Scanning Electron Microscope

Suraj Kumar Gupta, Paritosh Chaudhuri

Conceptual, Engineering Design & Fabrication Aspects for Support Structures for Super-

Conducting Central Solenoid of SST-1

Prosenjit Santra, Prabal Biswas, Kirit Vasava, Snehal Jayswal, Tejas Perekh, Pradeep Chauhan, Hitesh Patel and Subrata Pradhan

Seismic Analysis of ITER Multi-Purpose Deployer
Manoah Stephen Manuelraj, Krisna Kumar Gotewal, Pramit Dutta, Naveen Rastogi, Chang-Hwan Choi, and Alessandro Tesini

Study of Different Interlayer Materials with 2D Thermal Mechanical Analysis of Shield Blanket Module First Wall for ITER Like Machine using Tungsten as Plasma Facing Material
Ritesh Kumar Srivastava and Paritosh Chaudhuri

Design of 4k V, 1A Series Connected IGBT Switch for the Protection of Triode Based 2k W Stage ICRF Amplifier

Bhavesh R Kadia, Mandeepsingh Chhabada, YSS Srinivas, S. V. Kulkarni and ICRH Group

Commissioning of 2k V, 12 A Screen Grid Power Supply for Tetrode based 1.5MW Stage CWRF Amplifier

Kirit M Parmar, Bhavesh R Kadia, YSS Srinivas, S V Kulkarni and ICRH Group

Pre-Assembly Tests of 80 K Booster Systems Cryostats and V J line

R. Patel, GLN Srikanth, G. Mahesuriya, K. Patel, P. Shah, H. Nimavat, V. L. Tanna and S. Pradhan

Design and Development of PLC based offline Impedance Matching System for ICRH Experiment

Ramesh Joshi, H M Jadav, Aniruddh Mali, S V Kulkarni & ICRH Group

Integration of 128 channels for Monitoring, Acquisition and Control with Existing LHCD DAC system

Ramesh Joshi, Chetan Virani, Archana Wadhvani, P K Sharma & LHCD Group

PLC based development of Control, Monitoring and Interlock for 100kW, 45.6 MHz ICRH systems
Jadav Hiralal, Joshi Rameshkumar, Aniruddh K Mali, Kadia, Bhavesh, Parmar, Kiritkumar Maganbhai, S V Kulkarni

Development of signal conditioning and Interlocks circuits for offline impedance matching for ICRH Experiment

Aniruddh K Mali, Jadav, Hiralal, Joshi, Rameshkumar, S V Kulkarni

Heat Flux Estimation for Neutral Beam Line Components using Inverse Heat Conduction Procedures

P. Bharathi, V. Prahlad, K. Quereshi, L. K. Bansal, S. Rambabu, S.K. Sharma, Ravi. Patel, S. Parmar, P. J. Patel and U. K. Baruah

Control system for 80 K Liquid Nitrogen Booster system of SST-1

G. Mahesuria, R. Patel, D. Christian and V. L. Tanna

Indigenously Development and Testing of 4.5 kW Heater Based Hot Nitrogen Gas Baking System for High and Medium Pressure Tanks

D. Christian, P. Panchal, R. Panchal, R. Sharma, V. L. Tanna and Cryo Team

CFD Analysis of Heat Transfer Elements (HTEs) of second Calorimeter for Indian Test Facility (INTF)
Chirag Mistry, M. Venkatanagaraju, Chandramouli Rotti, Mainak Bandyopadhyay, Arun K. Chakraborty

Vessel Eddy Current measurement for SST-1 Tokamak

Subrata Jana, Subrata Pradhan, Jasraj Dhongde, Harish Masand, and SST-1 Team

Comparative Studies on CICC Based Cooling Channels Using Single Phase and Two-Phase Flowing Helium

G.K. Singh, V.L. Tanna, and S. Pradhan

Additional Cooling Requirements of Sst-1 Cryogenic System

V. L. Tanna, SST-1 cryo Team and S. Pradhan

Qt based Data Acquisition Application

Vismaysinh Raulji, Vishakha Modasai, Jaiminee Kataria, Hitesh Mandaliya, Praveena Kumara Pramila Gautam, Rachana Rajpal, H. D Pujara



Development of Programmable Solid State Variac for Baking Plasma Vacuum Chambers

Bharat Arambhadiya, Hardik Sharma Harshad Chauhan, Paresh Panchal, Samiran Mukherjee, Rachana Rajpal

Development of Density Control feedback System for SST-1 Tokamak

M. S. Khan, Khristi Yohan S, Dhongde Jasraj R., Semwal Pratibha, Kalpesh Dhanani, D. C Raval, Ziauddin Khan, S. Pradhan

Instrumentation & Control System Architecture for Experimental Helium Cooling Loop

T. Srinivas Rao, A. Saraswat, D. Mohanta

Recombiner High Power RF Testing using Klystron

K. K. Ambulkar, P. K Sharma, C. G. Virani, P. R. Parmar, S. Dalakoti, A. L. Thakur

SST 1 LHCD System: Full Grill Operation

P. K. Sharma, K. K. Ambulkar, P. K Sharma, C. G. Virani, P. R. Parmar, S. Dalakoti, A. L. Thakur

Status and Update on indigenous Mismatch Transmission Line (MMTL) System for ICH&CD Test Bed

Rohit Anand, Ajesh P., Akhil Jha, Paresh Vasava, Rajesh Trivedi, and Aparajita Mukherjee

Ethernet Based Datalogger for Upgrade Cooling Interlock System of ECRH System

Harshida Patel, Jatin Patel, B K shukla, N. Rajan Babu, Dharmesh P., Pragnesh Dhorajiya

Estimation of Hydrogen Transport to Liquid Lead Lithium under Condition of Gas Bubbling

Sudhir Rai and Amit Sircar

A Present Status of IECF Based Linear Neutron Source in CPR-IPR

D. Borgahain, N. Buzarbaruah, S.R. Mohanty

Status of Development of Compact ECR Ion Source for Accelerator

Sudhirsinh Vala, D. Rajyaguru, A T T Mostako, M. Abhangi, CVS Rao, T K Basu, B Sarkar, and A. Shyam

Installation & Commissioning of Cooling Water System for TPPML at CPP-IPR

M. Vasani, S. K. Sharma, Y. Trivedi, and D. Chenna Reddy

Integration of -70 kV, 22A High Voltage Power Supply with solid state crowbar and the LHCD System of SST-1

N. Rajan Babu, C. G. Virani, S. Dalakoti P. K. Sharma, K. K. Ambulka, P. R Parmar, A. L. Thakur, Pragnesh Dhorajiya

Soft-Xray Electronic for Temperature measurement in SST-1 Tokamak

Praveena Kumari, Jayesh V. Raval, Harsad chauhan, C.J Hansalia, Y. S.Joisa, Rachana Rajpal

Numerical Modeling for Effective Thermal Conductivity of Lithium Meta Titan ate (Li_2TiO_3) Pebble Bed with Different Packing Structures

M. Panchal, P. Chaudhuri

Establishment Pressure drop experiment set up for hydro formed Cryopanel

Jyoti Agarwal, V Lambade, Samiran Shanti Mukhejee, R Gangradey, C. Surani, P Panchal, P Nayak, J. S. Mishra

Design of Sealing Force Determination System (SFDS)

Vrushabh Lambade, Jyoti Agarwal, P Panchal, J S Mishra, S Mukherjee, R Gangradey

Characterization of Electromagnetic Pulse Welding Joints for Advanced Steels (ODS) Welding Applications

Ramesh Kumar Buddu, Shamsuddin Shaikh, P M Raole, B Sarkar

Preliminary Investigation of Hydrogen Generation during PBLI-Water Interaction

Arvind Kumar, Vilas C. Chaudhuri

Preliminary Investigation on Turbulent Heat Transfer to Lead Lithium in Developing Flow Regime

Arvind Kumar, V Mehta, A Saraswat, K. T. Sandeep, S. Verma, R. Bhattacharyay, A. Prajapati, A. jaiswal, S. Gupta

Grounding scheme of SST-1 tokamak
A.N. Sharma, P. Varmora, U. Prasad, Y. Khristi, D. Patel, S. J. Jadeja, S. Pradhan

Mechanical and Thermal Design of Steerable ECRH Launcher for SST-1 Tokamak
Hardik Mistry, and B K Shukla

Experimental Determination of Effectiveness of Thermal Insulating Materials for High Temperature Process Pipes in LLCB TBS
S. Verma, Aditya Kumar Verma, A. Saraswat, J. Chauhan, E.R. Kumar

Diagnosing Algorithm and Script Development for CFC based Imaging Diagnostics in Indian Testing Facility (INTF)
S. Debnath, Dass Sudhir, M. Bandyopadhyay, A. Chakraborty

RF Power Auditing in a Fusion Grade Inductively Coupled Plasma Source
Dass Sudhir, V.V. Jadhav, M. Bandyopadhyay, A. Chakraborty

Conceptual Design of an Experimental Set-Up for Hydrogen Isotopes Extraction from Liquid Lead Lithium
Rudreksh B. Patel, Sudhir Rai, Amit Sircar

Progress on Development of Solid State Proton Conducting Ceramic for Electrochemical Based Hydrogen Isotope Sensor
Deepak Yadav, Aroh Srivastava, Amit Sircar, P. M. Raole

Using Power factor ($\cos \phi$) as a tool to improve plasma load prediction of coupling models in RF plasma sources
V. V. Jadhav, Dass Shudhir, M. Bandyopadhyay, A. Chakraborty

Design and Performance Test of In-house designed Water-Cooled Jacket for Screw Compressor Electric motor of SST-1 Cryogenics System
G. Purwar, D. Christian, J. C. Patel, R. Panchal, V. L. Tanna

Development of Interface between MCNP-FISPACT-MCNP (IPR-MFM) based on Rigorous Two Step Method

A.K. Shaw, H. L. Swami, and C. Danani

Design and Development of New 100kVA, 100kV DC Isolated 1MHz RF Transformer for Robin at IPR
V. Mahesh, A. Gahlaut, K.G. Parmar, B. Prajapati, M. Bandyopadhyay, and A. Chakraborty

Development and Testing of Visual Inspection Applications for Tokamak Maintenance
Pramit Dutta, Naveen Rastogi, Shreya Joshi, K. K. Gotewal

Immersive Virtual Walk-through Development for Tokamak using Active Head Mounted Display
Pramit Dutta

Development of an integrated closed loop control system with virtual reality monitoring for Prototype Robotic Articulated System (PRAS)
Naveen Rastogi, Pramit Dutta, K.K. Gotewal

Microstructure and Hardness Properties of SS316L Laser Beam Weld Samples for Fusion Reactor Applications
Shamsuddin Shaikh, Ramesh Kumar Buddu, N. Chauhan, Raole P M, B Sarkar

Tailoring the operational Parameters for various experiments of Aditya Tokamak
R.L Tanna, J. Ghosh, P.K. Chattopadhyay, Harshita Raj, K.A. Jadeja, K.M. Patel, S.B. Bhatt, C.N. Gupta, V.K. Panchal, C. Chavda, N. Ramaiya, S. Banerjee, M.B. Chowdhuri, R. Manchanda, S. K. Jha, D. Raju, R. Jha, S. Purohit, J.V. Raval, Y.S. Joisa, C.V.S. Rao, Umesh Nagora, P.K. Atrey, S.K. Pathak, S.V. Kulkarni, B.K. Shukla, P.K. Sharma and the Aditya team

Critical Heat Flux studies for water cooled PFCs under one sided heating conditions
Vinay Menon, Rahul Chavan, Rajamannar Swamy, Kedar Bhoje, S. Belsare, S.S. Khirwadkar, Nikunj Patel, P. Mokaria

Plasma-Wall Interactions in Tungsten in Presence of Fusion Neutrons: Molecular Simulations and Surrogate Ion Irradiation Experiments
P. N. Maya, S.P. Deshpande, M. Warriar, P.M. Raole, S. Khirwadkar



Studies of Plasma Breakdown location in Aditya Tokamak

M. B. Chowdhuri, R.L. Tanna, N. Ramaiya, S. Banerjee, A. Amardas, K. A. Jadeja, C. N. Gupta, S. B. Bhatt, P. K. Chattopadhyay, J. Ghosh and Aditya team

Parametric analysis of in TBM box leaks in LLCB TBM

Vilas Chaudhari, and K. T. Sandeep

Experimental Set-up for Negative Hydrogen Ion Extraction for CPP.

V. N. Patel, S. J. Jadeja, V.D. Kaila, Riaz Ajmeri, V. R. Prajapati, S. K. Patanaik, D. C. Raval, Siju George, D. Chenna Reddy

Parametric study of pellet speed dependence in pipe gun type pellet injector

J. Mishra, R. Gangradey, P. Panchal, S. Mukherjee, P. Nayak, J. Agarwal and V. Lambade

Evaluation of Acoustic Emission Technique for Structural Components Integrity Inspection

S. V. Ranganayakulu, B. Samrat Goud, Ramesh Kumar Buddu

Multi-pass TIG welding process: Simulating Thermal Model for SS304

Vemanaboina Harinath, S Akella, Ramesh Kumar Buddu, G. Edision

Effect of Stray Magnetic Fields on Ohmic Discharges in Tokamak ADITYA

Sharvil Patel, R. L. Tanna, J. Ghosh, P. K. Chattopadhyay, K. Sathyanarayana, Rohit Kumar, Vaibhav Ranjan, Harshita Raj, Ram Krushna Panchal, M. B. Kalal

Estimate on the Physical Sputtering of Divertor Armor Materials

S. Adhikari, D. Dutta, R. Moulick, and K.S. Goswami

Instrumentation for NBI SST-1 Cooling Water System

Karishma Qureshi, Paresh Patel, M. R. Jana, L.K. Bansal, S. L. Parmar, C. B. Sumod, Vijay Vadher, Dipal Thakker, L. N. Gupta, B. Choksi, P. Bharathi, S. K. Sharma, C. Chakrapani, S. Rambabu, B.

Pandya, Sridhar, Nilesh Contractor, V. Prahlad and U.K. Baruah

Electrical Characteristics of a DC Non-Transferred Arc Plasma Torch using Theory of Dynamic Similarity

V. Yugesh, G. Ravi, and K. Ramachandran

Stochastic Sheath Heating in Current- Driven Capacitive Discharges using Higher Order Sinusoidal Signals

S Sharma, S K Mishra, P K Kaw, A. Das, N Sirse and M M Turner

Deposition and Qualification of Tungsten Coatings on Graphite Produced by Radio Frequency Plasma Assisted Chemical Vapor Technique

Uttam Sharma, Sachinsingh Chouhan, A. K. Sanyasi, K. A. Jadeja, J. Ghosh, J. Sharma

Effect of Geometrical Variation of Pressure Coil on Magnetic Pulse Welding of Flat Metal Sheets

Subhanarayan Sahoo, Rajesh Kumar, Anurag Shyam, Saurabh Kumar, and Rahul Kosthi

Field Commissioning and Maintenance of Power Transformers

Prakash Parmar, Ashok D. Mankani, Supriya Nair, C. K. Gupta

Non-Intrusive Power Measurement in Pulsed Power Generator

Rajesh Kumar, G. Veda Prakash, Saurabh Kumar and A. Shyam

Operation & Control of Aditya Pulsed Power Supply through Computer and VMEBUS for Conduction of Experimental Plasma Discharges of Aditya Tokamak

Kunal S. Shah, Moti N. Makwana, C. N. Gupta, Joydeep Ghosh

Component Testing Facility for a 200kJ Pulsed Power System at CPP-IPR

S. Borthakur, N. Talukdar, N. K. Neog, T.K. Borthakur, R. Kumar, R. Verma, A. Shyam

Effect of Finite Beam Width on Current Separation in Beam-Plasma System: Particle-in-Cell Simulation

- Atul Kumar, Chandrasekhar Shukla, Bhavesh Patel, Amita Das
Dynamics of Silver Plasma Evolution during Laser Ablation in Liquid Media
N. Parvathy, Jemy James, Alok Tiwari, N. Ramasubramanian, Nandakumar Kalarikkal
- Characterization of Plasma Plume Produced by Thin Film Laser Ablation
Alamgir Mondal, R. K. Singh, Ajai Kumar
- Dynamics of Laser Plasma Expansion in Confined Geometry
Ajai Kumar, Bhupesh Kumar and R. K. Singh
- Analysis of Laser Beam Misalignment using Quadrant Photo Detector for Feedback Control Loop
S. Sunil, Nidhi Kanani, Amit K. Srivastava, Ziauddin Khan and Manish Thakker
- Molecular Dynamics Simulation of Rayleigh-Taylor Instability in Dusty Plasmas
Sandeep Kumar, Amita Das, Predhiman Kaw, and Sanat Kumar Tiwari
- Shift in Equilibrium Dust Void Geometry under Acoustic Radiation Pressure
Rinku Mishra, and M. Dey
- Dust vortex and Boundary Flow in 2-Dimensional Fluid Dynamic of Dusty Plasmas
Madhuchandra Laishram
- The Effect of Variation of Discharge Current on the Behaviour of Dust Vortices
Manjit Kaur, Sayak Bose, P. K. Chattopadhyay, J. Ghosh and Y. C. Saxena
- Sub and Super Luminal Dipoles in Generalized Hydrodynamic (GHD) Model of Strongly Coupled Visco-Elastic Fluid
Vikram Dharodi, Bhavesh Patel, and Amita das
- Formation of Tungsten Nanoparticle in Low Pressure DC Magnetron Discharge
Sanjib Sarkar, M. Chaudhuri, A. Satyaprasad, and S. Mukherjee
- Experimental Investigation of Dust Acoustic Shocks in Flowing Complex Plasmas
P. Bandyopadhyay, S. Jaiswal, and A. Sen
- A Study of self-excited dust acoustic waves in the dust volume trapped at diffused plasma in variable cross-section tube
Mangilal Choudhary and S. Mukherjee
- Plasma Oscillations by Molecular Dynamics Simulation
Sagar Sekhar Mahalik and Mrityunjay Kundu
- Disruption and VDE Modeling for DIII-D using TSC Code
Amit K. Singh, I. Bandyopadhyay
- Simulations of ELMs in presence of RMPs using CUTIE Code
D. Chandra, A. Thyagaraja, A. Sen, and P. Kaw
- Study of Steady State Distribution of Oxygen Ions in Aditya Tokamak Plasma
Amrita Bhattacharya, Joydeep Ghosh, M. B. Chowdhuri, Prabhat Munshi
- Li Vapour Density Measurement using Spectral Interferometry for the PWFA Plasma Source at IPR
V. Sivakumaran, K. K. Mohandas, Sneha Singh, and Ravi A. V. Kumar
- Measurement of Plasma Parameters in CPS Device
Biswambhar Mohanty, Rita Paikaray, Subrata Samantaray, Parthasarathi Das, Narayan Chandra Sasini, Gourishankar Sahoo, Joydeep Ghosh, Amulya Kumar Sanyasi
- Estimation and Experimental Verification of Mueller Matrices for Various Metal Mirrors
Asha Adhiya, Rajwinder Kaur and Pabitra Kumar Mishra
- Core Ion Temperature Measurements using Charge Exchange Neutral Particle Analyser for Aditya Plasma Discharges with and Without Radio Frequency Heating Experiments
Kumar Ajay, Santosh P. Pandya, Snehlata Gupta Agarwal, Pragnesh Thaker & ADITYA team
- Lanthanum bromide scintillator based hard X-ray



spectroscopy diagnostic system to study the runaway electron in Aditya Tokamak

S. Purohit, Y. S. Joisa, J. V. Raval, R. Tanna, K. A. Jadeja, B.K.Shukla, A. Kumar, J. Ghosh and Aditya Team

Extraction of Various information from SST-1 Plasma using Singular Value Decomposition

Manoj Kumar Gupta, Chesta Parmar, Kiran Patel, Ajai Kumar

Development of FMCW Reflectometry at IPR

JJU Buch and Surya K. Pathak

Design and Development of 100 GHz Band Pass Filter

Praveen Kumar Atrey, Dhaval Pujara and Subroto Mukherjee

Transient Heater Circuitry for Emissive Probe Measurements in LVPD

Nikunj Bhavsar, P. K. Srivastava, A. K. Sanyasi, Prabhakar Srivastav and L. M. Awasthi

Study of Plasma discharge evolution and edge turbulence with fast visible imaging in the Aditya tokamak

Santanu Banerjee, R. Manchanda, M. B. Chowdhuri, N. Ramaiya, N. Parmar, J. Ghosh, R. L. Tanna, P.K.Chattopadhyay, R. Jha, D. Raju, B. K. Shukla, P. K. Sharma and the Aditya Team

Te Measurement with of Soft X-Ray Diagnostics in SST-1 Tokamak

Y Shankar Joisa, Jayesh Raval, S. Purohit, Ranjana Manchanda, Malay Chaudary, A. Kumar and SST-1 Team

Impurity Radiated power during lithimisation experiment in Aditya Tokamak

M. V. Gopala Krishna, R. Jha, Kumudni Tahiliani, Smeer Kuma, Praveena, Ranjan Manuchanda, Joydeep Ghosh, Kumar Jadeja, S. B. Bhatt

Up-Down Asymmetry Studies in Impurity Emission from Aditya Tokamak

Nilay Ramaiya, R. Manchanda, M. B. Chowdhuri, Niral Virani, S. Banerjee, Joydeep Ghosh, R. L. Tanna and Aditya Team

Indirect Heated Langmuir Probe Diagnostic for Multi-cusp Plasma Device

Meenakshee Sharma, A. D. Patel, N. Ramasubramanian

Temperature Fluctuation in LVPD: A Comparison of Triple and Double Probe Methods

Prabhakar Srivastav, A. K. Sanyasi, P. K. Srivastava, Nikunj Bhavsar, L. M. Awasthi and R. Jha

Indirect Heated Langmuir Probe Diagnostic for alkali plasma in Multicusp Plasma Device

A.D. Patel, Meenakshee Sharma, N. Ramasubramanian, P. K. Chattopadhyay

Preparation and Characterization of α -Fe Nanopowders by DC Transferred Arc Plasma

E. M. Koushika, G. Shanmugavelayutham, C. Balasubramanian, P. Saravanan

Design of Cryostat Skirt Support Skidding System

Girish K Gupta, Saroj Jha, Manish Pandey and Anil Bhardwaj

Design and Analysis of Cooling System for ITER-India Gyrotron Test Facility

Amit Yadav, Vipal Rathod, Deepak Mandge, Sharan E Dilip, Ronak Shah, Anjali Sharma, Aditya P Singh, Rakesh Ranjan, and S. L. Rao

Integrated design of 1.5MW RF dummy load System

JVS Hari Krishna, Rohit Agarwal, Harsha Machchhar, Raghuraj Singh, R. G. Trivedi, Kumar Rajnish, P. Ajesh, Manoj Patel, Akhil Jha, Kartik Mohan, Gajendra Suthar, Dipal Soni, Rohit Anand, Sriprakash Verma, Pareshkumar N. Vasava, Hriday N. Patel, Hrushikesh N. Dalicha, Aparajita Mukherjee

Design and Development of Ion Pump Power Supply

S. Dalakoti, V. Shyammohan, C. G. Virani, P. K. Sharma, K. K. Ambulkar

CFD Analysis of RF Cooling Coil and Experimental Validation for NB Sources

Darshak Shah, Jignesh Patel, Dhananjay Kumar Singh, Ashish Yadav, Jaydeep Joshi, Chandramouli

Rotti, Mainak Bandyopadhyay, Arun Chakraborty

Phase Mixing of Relativistically Intense Wave Packets in a Cold Plasma
Arghya Mukherjee, Sudip Sengupta

Overview of Design and R&D activities of Indian LLCB TBM for ITER
Paritosh Chaudhuri and Indian TBM Team

On the Flat Top Magnetic Profile of Electromagnet in the CPS Device
Subrata Samantaray, Rita Paikaray, Gourishankar Sahoo, Parthasarathi Das, Joydeep Ghosh

Trapped Particles Nonlinearity Produced Solitary Wave Structures in Kinetic Plasma Micro instability Simulations
Debraj Mandal and Devendra Sharma

International Conference on Magnetic Materials and Applications (ICMAGMA-2015), VIT University, Vellore, Tamilnadu, India, 2-4 December 2015

Investigations on magnetic nanoparticles synthesized by Green chemical method
Lavita Sarma, Sidananda Sarma, Ananthakrishnan Srinivasan and M. Kakati

National Welding Seminar (NWS-2015), IIW-India Mumbai Branch, 9-11 December 2015

Welding procedure qualification for dissimilar welding between 316LN and XM-19 stainless steel for ITER application
Hemant Kumar, G. Srinivasan, S. K. Albert, A.K. Bhaduri, Shailesh Kanpara, Alpesh Patel, Samir Khirwadkar

16th Workshop on Fine Particle Plasmas, National Institute for Fusion Science, Toki city, Gifu, Japan, 10-11 December 2015

Conceptual design of an extraction system for a surface assisted volume negative hydrogen ion source
S.S. Kausik, B. Kakati, D. Kalita, B.K. Saikia, and M. Bandyopadhyay

1st International Conference on Advanced Materials for Power Engineering (ICAMPE-2015), Kottayam, India, 11-13 December 2015

Er₂O₃ Coating Process and Characterization: Nuclear Fusion Reactor Perspective
P. A. Rayjada

International Conference on Nano Science, Nano Technology and Advanced Materials (NANOS 2015), Department of Chemistry, GITAM Institute of Science, Gitam University, Visakhapatnam, 14-17 December 2015

Processing and Characterization of Silica Nano-Particles by Sol-Gel Method for Application of Nano-Composites
Sumit Kumar, C. Jariwala, R. Pillai, Deepak Rawtani and Y. K. Agrawal

10th Asia Plasma & Fusion Association Conference (APFA 2015), Institute for Plasma Research, Gandhinagar, India, 14-18 December 2015

Data Handling System for SST-1
Harish Masand, Manisha Bhandarkar, Aveg kumar, Hitesh Kumar Gulati, Kiritkumar B Patel, Kirti Mahajan, Jasraj Dhongde, Hiteshkumar Chudasama, Subrata Pradhan

Effect of Electric field on Charged Particle Drift across a Magnetic field
P. Hazarika, M. Chakraborty, B. K. Das, M. Bandyopadhyay

The Role of Equilibrium Flows in Temperature-Gradient-Driven Modes in Hot Tokamaks
Deepak Verma, Aditya K Swamy, Rajaraman Ganesh, Stephan Brunner, Laurent Villard

Droplet shaped anode double layer and electron sheath formation in magnetically constricted anode
S. Chauhan, M. Ranjan, M. Bandyopadhyay, and S. Mukherjee

3D Character of Plasma Transport in the Aditya Limiter Scrape-off Layer
Bibhu Prasad Sahoo, Devendra Sharma, Ratneshwar Jha, Yuhe Feng



Fast Visible Imaging and Study of Edge Turbulence in the Aditya Tokamak

Santanu Banerjee, Ranjana Manchanda, Malay Bikas Chowdhuri, Nilam Ramaiya, Navin Parmar, Joydeep Ghosh, Rakesh L Tanna, Braj Kishore Shukla, Pramod K Sharma, Aditya team

Controllable Transition from Positive Space Charge to Negative Space Charge in an Inverted Cylindrical Magnetron

Ramkrishna Rane, Mainak Bandyopadhyay, Mukesh Ranjan, Subroto Mukherjee

Comparison of Different Atomic Databases used for Evaluating Transport Coefficients in Aditya Tokamak

Malay Bikas Chowdhuri, Joydeep Ghosh, Santanu Banerjee, Ranjana Manchanda, Nilam Ramaiya, Parveen Kumar Atrey, YShankara Joisa, Rakesh L Tanna, Prabal K Chattopadhyay, Chet Narayan Gupta, Shailesh B Bhatt, Motoshi Goto, Izumi Murakami

Neutral Particle Profiles during ICRH Experiments in Aditya Tokamak

Nilam Ramaiya, Ritu Dey, Ranjana Manchanda, Malay Bikas Chowdhuri, Santanu Banerjee, Niral Virani, Rakesh L Tanna, Jayesh V Raval, Y Shankara Joisa, Parveen Kumar Atrey, Shailesh B Bhatt, Chet Narayan Gupta, Sanjay V Kulkarni, Prabal K Chattopadhyay, Joydeep Ghosh

Understanding of Impurity Behavior in SST-1 Plasmas Using Visible Spectroscopy

Ranjana Manchanda, Nilam Ramaiya, Malay Bikas Chowdhuri, Santanu Banerjee, Joydeep Ghosh, SST-1 Team

Observation of Plasma Shift in SST-1 using Optical Imaging Diagnostics

Manoj Kumar Gupta, Chesta Parmar, Vishnu K Chaudhari, Ajai Kumar, SST-1 Team

Estimation of Spectrally Resolved Total Radiation Power loss in Aditya Tokamak and its Comparison with Experimental Measurements

Kumudni Tahiliani, Malay Bikas Chowdhuri, Ratneshwar Jha, Parveen Kumar Atrey, Y Shankar Joisa, Joydeep Ghosh, Rakesh L Tanna, Aditya Team

Ponderomotive Density Modulation in Two Ion Tokamak Plasma

J K Atul, S K Singh, S Sarkar, O V Kravchenko

Study of Neutral Particle Transport in Aditya Tokamak Plasma using DEGAS2 Code

Ritu Dey, Joydeep Ghosh, Malay Bikas Chowdhuri, Ranjana Manchanda, Santanu Banerjee, Nilam Ramaiya, Aditya Team

Modeling of Eddy Current distribution and Equilibrium Reconstruction in the SST-1 Tokamak

Santanu Banerjee, Amit Kumar Singh, Deepti Sharma, Srinivasan Radhakrishnana, Raju Daniel, Y Shankara Joisa, Parveen Kumar Atrey, Surya Kumar Pathak, SST-1 Team

Equilibrium Reconstruction of Plasma Discharges in the Aditya Tokamak

Deepti Sharma, Santanu Banerjee, Amit Kumar Singh, Srinivasan Radhakrishnana, Raju Daniel, Rakesh L Tanna, Joydeep Ghosh, Y Shankara Joisa, Parveen Kumar Atrey, Surya Kumar Pathak, Aditya Team

Ohmic Discharges with Improved Confinement in Tokamak Aditya

Rakesh L Tanna, Harshita Raj, Joydeep Ghosh, Prabal K Chattopadhyay, Sharvil Patel, Kumarpalsinh A Jadeja, Kaushal M Patel, Shailesh B Bhatt, Chet Narayan Gupta, Kunal Shah, Motibhai Makwana, Narendra Patel, Vipul K Panchal, Chhaya Chavda, Pramod Sharma, Malay Bikas Chowdhuri, Santanu Banerjee, Nilam Ramaiya, Ranjana Manchanda, Raju Daniel, Sameer Kumar Jha, Kumudni Tahiliani, Praveenlal Edappala, Shishir Purohit, Y Shankar Joisa, Jayesh V Raval, C V S Rao, Parveen Kumar Atrey, Surya Kumar Pathak, Ratneshwar Jha, Amita Das, Dhiraj Bora

Investigation of Aditya Tokamak Plasmas with Lithiumized Wall

Niral Virani, Malay Bikas Chowdhuri, Kumarpalsinh A Jadeja, Joydeep Ghosh, Ranjana Manchanda, Nilam Ramaiya, Santanu Banerjee, Jayesh V Raval, Y Shankara Joisa, Umeshkumar C Nagora, Parveen Kumar Atrey, Rakesh L Tanna, Prabal K Chattopadhyay, Chet Narayan Gupta, Shailesh B Bhatt, Aditya team

Estimation of Vacuum Magnetic Fields due to Ohmic Coils in Aditya Upgrade tokamak

Krishana Kumari K, Rohit Kumar, Rakesh L Tanna, Joydeep Ghosh, Prabal K Chattopadhyay, Srinivasan Radhakrishnana, Sharvil Patel, Raju Daniel, Someswar Dutta, Dhiraj Bora, Yogesh C Saxena, Aditya Team

Divertor Coil Power Supply in Aditya Tokamak for improved Plasma Operation

Vaibhav Ranjan, Kunal Shah, Motibhai N Makawana, Chet Narayan Gupta, A Varadharajulu, Joydeep Ghosh, Rakesh L Tanna, Prabal K Chattopadhyay, Raju Daniel, Srinivasan Radhakrishnana, Yogesh C Saxena

The First Results of Te Measurement with of Soft X-Ray Diagnostics in SST-1 Tokamak

Jayesh V Raval, Shishir Purohit, Y Shankara Joisa, Ajai Kumar

An Overview of SST-1 Diagnostics and Results from Recent Campaigns

Ajai Kumar, Asha N Adhiya, Hemchandra C Joshi, Janmejy U Buch, Jayesh V Raval, Jinto Thomas, Joydeep Ghosh, Kiran Patel, Kumar Ajay, Kumudni Tahiliani, M V Gopalakrishna, Malay Bikas Chowdhuri, Manoj Kumar, Neha Singh, Nilam Ramaiya, Parveen Kumar Atray, Pabitra K Mishra, Ratneshwar Jha, Raju Daniel, Rajwinder Kaur, Ranjana Manchanda, Sameer Kumar Jha, Santanu Banerjee, Santosh P Pandya, Shishir Purohit, Shwetang N Pandya, Snehlata Gupta, Surya Kumar Pathak, Umeshkumar C Nagora, Varsha Siju, Vishnu K Chaudhari, Y Shankar Joisa

Design and Development of AXUV-based Soft X-Ray Diagnostic Camera for ADITYA Tokamak

Jayesh V Raval, Shishir Purohit, Y Shankara Joisa, Joydeep Ghosh, Rakesh L Tanna, Kumarpalsinh A Jadeja, Ajai Kumar, Shailesh B Bhatt, Praveena Kumari, Vismaysinh Raulji, Minsha Shah, Rachana Rajpal

Observation of MHD Phenomenon for SST-1 Superconducting Tokamak

Manisha Bhandarkar, Jasraj Dhongde, Subrata Pradhan

The Determination of Plasma Radial Shafranov

Shift (ΔR) and Vertical Shift (ΔZ) Experimentally using Magnetic Probe and Flux Loop Method for SST-1 Tokamak

Subrata Jana, Jasraj Dhongde, Harish Masand, Subrata Pradhan

Development of new diagnostics for WEST

P. Lotte, P. Moreau, C. Gil, J. Bucalossi, M.H. Aumeunier, J.M. Bernard, C. Bottereau, C. Bourdelle, Y. Camenen, M. Chernyshova, F. Clairet, T. Czarski, M. Choi, G. Colledani, Y. Corre, X. Courtois, R. Daniel, D. Davis, P. Devynck, D. Douai, A. Escarguel, D. Elbeze, C. Fenzi, W. Figacz, J.C. Giacalone, R. Guirlet, J. Gunn, S. Hacquin, X. Hao, J. Harris, G.T. Hoang, F. Imbeaux, S. Jablonski, A. Jardin, H.C. Joshi, G. Kasprovicz, C. Klepper, E. Kowalska-Strzeciwlk, M. Kubkowska, A. Kumar, V. Kumar, W. Lee, B. Luy, P. Malard, L. Manenc, Y. Marandet, D. Mazon, O. Meyer, M. Missirlian, D. Molina, G. Moureau, Y. Nam, E. Nardon, T. Nicolas, R. Nouailletas, H. Park, J.Y. Pascal, K. Pozniak, N. Ravenel, R. Sabot, F. Samaille, J. Shen, JM Traverre, E. Tsitrone, S. Varshney, S. Vartanian, D. Volpe, F. Wang, G. Yun, and WEST team

Observation on Runaway Discharges in SST-1 Experiments

Kiritkumar B Patel, Subrata Pradhan

Hard X-ray Diagnostic for SST-1

Shishir Purohit, Jayesh V Raval, Y Shankara Joisa, Ajai Kumar, SST-1 Team

Study of MHD Activities in the Plasma of SST-1

Jasraj Dhongde, Manisha Bhandarkar, Subrata Pradhan, Sameer Kumar Jha, SST-1 Team

A Fixed Frequency Reflectometer to Measure Density Fluctuations at Aditya Tokamak

Parveen Kumar Atrey, Dhaval Pujara, Subroto Mukherjee

Helium Beam Diagnostics for the Estimation Electron Temperature and Density in SST-1

Vishal Pillai, Neha Singh, Jinto Thomas, Rajesh Kumar Singh, Hem Chandra Joshi, Ajai Kumar

Operation of ADITYA Thomson Scattering System: Measurement of Temperature and Density



Jinto Thomas, Vishal Pillai, Neha Singh, Kiran Patel, Lingeshwari G, Zalak Hingrajiya, Ajai Kumar

Installation and Commissioning of SST-1 Thomson scattering system

Jinto Thomas, Vishal Pillai, Neha Singh, Kiran Patel, Vishnu K Chaudhari, Ajai Kumar

Limiter and Divertor Systems – Conceptual and Mechanical Design for Aditya Tokamak Upgrade

Kaushal Patel, Kulav Rathod, Kumarpalsinh A Jadeja, Shailesh B Bhatt, Deepti Sharma, Srinivasan Radhakrishnana, Raju Daniel, Rakesh L Tanna, Joydeep Ghosh, Prabal K Chattopadhyay, Yogesh C Saxena, Aditya Team

Development of Gas Puffing System for LHCD Experiment in Aditya Tokamak

Kumarpalsinh A Jadeja, Kaushik S Acharya, Kaushal M Patel, Nilesh D Patel, Kalpesh M Chaudhary, Shailesh B Bhatt, Pramod K Sharma, Kirankumar K Ambulkar, Pramod R Parmar, Chetan G Virani, Saifali Dalakoti, Arvindkumar L Thakur, Rakesh L Tanna, Santanu Banerjee, Joydeep Ghosh

Structural Analysis of New Vacuum Vessel for Aditya Tokamak Upgrade

Kulav Rathod, Joydeep Ghosh, Shailesh B Bhatt, Rakesh L Tanna, Kumarpalsinh A Jadeja, Kaushal M Patel

IGBT Based Active Clamping Protection Scheme for SST-1 PF Coils

Azad Makwana, Deven Kanabar, Chiragkumar Dodiya, Kalpesh Doshi, Yohan Khristi, Subrata Pradhan

Thermal Imaging of SST-1 Limiters

Shwetang N Pandya, Santosh P Pandya, Kumar Ajay

The Upgradation of Aditya Tokamak

Shailesh B Bhatt, Joydeep Ghosh, Rakesh L Tanna, Chhaya Chavda, Chet Narayan Gupta, Prabal K Chattopadhyay, Raju Daniel, Srinivasan Radhakrishnana, Kaushik S Acharya, Kalpesh M Chaudhary, Someswar Dutta, Kumarpalsinh A Jadeja, Madan B Kalal, Sanjay V Kulkarni, Kumari

(K) Krishna, Moti Makwana, Rohitkumar Panchal, Vipul K Panchal, Kaushal M Patel, Narendra Patel, Nilesh Patel, Sharvil Patel, Vijay Patel, Harshita Raj, N. Ramasubramanian, Vaibhav Ranjan, Kulav Rathod, Devraj H Sadharkiya, Kunal Shah, Krishnamachari Sathyanarayana, Deepti Sharma, Pramod K Sharma, Braj Kishore Shukla, A Varadharajulu, Dinesh S Varia, Ajai Kumar, Ratneshwar Jha, Amita Das, Abhijeet Sen, Yogesh C Saxena, Predhiman Krishan Kaw, Dhiraj Bora

Development of Non-circular Metal Seal for Aditya Tokamak Upgrade Vacuum Vessel

Kaushik S Acharya, Kaushal M Patel, Kumarpalsinh A Jadeja, Kulav Rathod, Nilesh D Patel, Kalpesh M Chaudhary, Shailesh B Bhatt, Aditya Team

Study of the plasma SOL with fast reciprocating probe diagnostics on the SST-1 tokamak

M V Gopalakrishna, Ratneshwar Jha, Sameer Kumar Jha, Kumudni Tahiliani, Santanu Banerjee, Manoj Kumar Gupta, Pramila Gautam, Dilip Raval, Snehal Jaiswal, Pradeep Chauhan, Subrata Pradhan, SST-1 Team

Conceptual design of Plasma position control of SST-1 Tokamak using vertical field coil

Hitesh Kumar Gulati, Kiritkumar B Patel, Jasraj Dhongde, Kirti Mahajan, Aveg Kumar, Harish Masand, Manisha Bhandarkar, Hiteshkumar Chudasama, Subrat Jana, Chet Narayan Gupta, Subrata Pradhan

Implementation of SST-1 plasma position control using vertical field

Kirti Mahajan, Jasraj Dhongde, Kiritkumar B Patel, Hitesh Kumar Gulati, Aveg Kumar, Harish Masand, Manisha Bhandarkar, Hiteshkumar Chudasama, Subrat Jana, Chet Narayan Gupta, Subrata Pradhan

Preparation of W/CuCrZr Monoblock Test Mock-up using Vacuum Brazing Technique

Kongkham Premjit Singh, Samir S Khirwadkar, Kedar Bhope, Nikunj Patel, Prakash K, Mokaria, Mayur Mehta

Design and Performance of Vacuum System for High Heat Flux Test Facility

Rajamannar Swamy Kidambi, Prakash K Mokaria, Samir S Khirwadkar, Sunil Belsare, Mohammed Shoab Khan, Tushar Patel, Deepu S Krishnan

Thermal Shock Behavior of Tungsten & Tungsten Alloy Materials under Transient High Heat Load Conditions

Shailesh Kanpara, Samir S Khirwadkar, Sunil Belsare, Kedar Bhope, Rajamannar Swamy Kidambi, Prakash K Mokaria, Nikunj Patel, Tushar Patel, Narendra Chauhan, Nirav Jamnapara

Characterization of a Segmented Plasma Torch Assisted High Heat Flux (HHF) System for Performance Evaluation of Plasma Facing Components in Fusion Devices

Aomoa Ngangom, Trinayan Sarmah, Puspa Sah, Joydeep Ghosh and Mayur Kakati

Indigenously Developed Large Pumping Speed Cryoadsorption Cryopump

Ranjana Gangradey, Samiran Shanti Mukherjee, Jyoti Agarwal, Manoahstephen Manuelraj, Paresh Panchal, Pratik Kumar Nayak, Jyoti Shankar Mishra, Vrushabh Lambade, Pawan Bairagi, Vijay Kumar, Reena Sayani, Srinivasan Kasthurirengan, Swarup Udgata, Vijay Shankar Tripathi

Indian Single Pellet injection System for Plasma Fuelling Studies

Ranjana Gangradey, Jyotishankar Mishra, Samiran Shanti Mukherjee, Paresh Panchal, Pratik Kumar Nayak, Hardik Sharma, Haresh Patel, Pramit Dutta, Naveen Rastogi, Jyoti Agarwal

Development of Heat Sink Concept for Near-term Fusion Power Plant Divertor

Sandeep Rimza Sandy, Samir S Khirwadkar, Karupanna Velusamy

Characterization of Discharge Plasma in Cylindrical IECF Device

Neelanjan Buzarbaruah, Nilam Jyoti Dutta, Davashree Borgohain, Smruti Ranjan Mohanty

Serial Interface through Stream Protocol on EPICS Platform for Distributed Control and Monitoring

Arnab Das Gupta, Amit Srivastava, Sunil Susmithan, Ziauddin Khan

Development of Data Acquisition Set-up for Steady-state Experiments

Amit Srivastava, Arnab Das Gupta, Sunil Susmithan, Ziauddin Khan

Prototyping of Radial Plates for Fusion Relevant Superconducting Magnets

Mahesh Ghate, Dhaval Bhavasar, Arun Panchal, Swaroop Udgata, Subrata Pradhan

Application of Articulated Absolute Co-ordinate Measuring Machine for Quality Control in Manufacturing of ELM Control Coil

Dhaval Bhavasar, Mahesh Ghate, Subrata Pradhan

Indigenously Developed Bending Strain Setup for I-V Characterization of Superconducting Tapes and Wires

Arun Panchal, Anees Bano, Mahesh Ghate, Piyush Raj, Subrata Pradhan

RF Assisted Glow Discharge Condition Experiment in SST-1 Tokamak

Dilip Raval, Ziauddin Khan, Siju George, Kalpeshkumar R Dhanani, Yuvakiran Paravastu, Pratibha Semwal, Prashant Thankey, Mohammad Shoaib Khan, Subrata Pradhan

Baking and Helium Glow Discharge Cleaning of SST-1 Tokamak with Graphite Plasma Facing Components

Pratibha Semwal, Ziauddin Khan, Dilip Raval, Kalpeshkumar R Dhanani, Siju George, Yuvakiran Paravastu, Arun Prakash A, Prashant Thankey, Gattu Ramesh Babu, Mohammad Shoaib Khan, Partha Saikia, Subrata Pradhan

Design and Integration of SMBI System for SST 1

Siju George, Yuvakiran Paravastu, Mohammad Shoaib Khan, Kalpeshkumar R Dhanani, Dilip Raval, Ziauddin Khan, Santanu Banerjee, Subrata Pradhan

Neutron Measurements from Beam-Target Interactions with Deuterium Ion Beam

Sudhirsinh Vala, A T T Mostako, Mitul Abhangi, C V S Rao, Rajnikant Makwana, T K Basu

Electron Beam Welding: Study of Process Capabilities and Limitations towards Development of Nuclear Components

Gautam Vadolia, Kongkham Premjit Singh

Thermal Response of Actively Cooled Tungsten Monoblock during Inhomogeneous Surface Heat Loads



Yashashri Patil, Samir S Khirwadkar, Deepu S Krishnan

Consistency Checks in Beam Emission Modeling for Neutral Beam Injectors

Bharathi Punyapu, Prahlad Vattipalle, Sanjeev Kumar Sharma, Ujjwal Kumar Baruah, Brendan Crowley

Computational Fluid Dynamics Analysis of Heat Transfer Elements for SST-1 Neutral Beam Line

Ravi Patel, Mahesh Ghate, Bharathi Punyapu, Rajesh Patel, Prahlad Vattipalle

Er₂O₃ Coating Development and Improvisation by Metal Oxide Decomposition Method

Pratipalsinh A Rayjada, Amit Sircar, Prakash M Raole, Lalit M Manocha, Raseel Rahman

Design of CPLD-DAC Based Probe Bias Generator and Current Measurement Electronics

Minsha Shah, Rachna Rajpal, Amitkumar D Patel, Meenakshee Sharma, Narayanan Ramasubramanian

Nanoscale Coatings of Tungsten by Radio Frequency Plasma Assisted Chemical Vapor Deposition on Graphite

Uttam Sharma, Sachin Singh Chouhan, Amulya Kumar Sanyasi, Kumarpalsinh A Jadeja, Joydeep Ghosh, J. Sharma

Multi-scale Modeling of Neutron Induced Radiation Damage in Tungsten

Maya P N, Shishir P Deshpande, Manoj Warriar, Prithwish Nandi, Prakash M Raole, Samir S Khirwadkar

Role of ECRH in SST-1 Tokamak Plasma

Braj Kishore Shukla, Dhiraj Bora, Ratneshwar Jha, Subrata Pradhan

Design of 1 MHz Solid State High Frequency Power Supply

Darshan Kumar Parmar, N P Singh, Sandip Gajjar, Aruna Thakar, Amit Patel, Bhavin Raval, Hitesh Dhola, Rasesh Dave, Dishang Upadhyay, Vikrant Gupta, Niranjana Goswami, Kush Mehta, Ujjwal Kumar Baruah

Neutron Induced Reaction for Long-lived Isotopes Produced in Fusion Materials

Bhawna Pandey, C V S Rao, Jyoti Pandey, Mayank Rajput, G Vaitheeswaran, T K Basu, H M Agrawal

Development of a Neutronics Facility using RFQ Accelerator as the Basic Tool

Renu Bahl, Biswanath Sarkar, Anurag Shyam, Rajesh Kumar, Mridula Mittal, Sumit Kumar

Design of a Prototype Positive Ion Source with Slit Aperture Type Extraction System

Sanjeev Sharma, Prahlad Vattipalle, Bhargav Choksi, Bharathi Punyapu, Rambabu Sidibomma, Sridhar B, Ujjwal Kumar Baruah

Optimization of Geometrical Parameters for High Heat Flux Components (Vaportrons)

Sajal Thomas, Shrishail B Padasalagi

Design and Development of CRIO Based Data Acquisition and Control System for High Voltage Bushing Experiment

Himanshu Tyagi, Sejal Shah, Jignesh Soni, Ratnakar Kumar Yadav, Kartik J Patel, Hiren Mistri, Deepak Parmar, Jignesh Bhagora, Dheeraj Kumar Sharma, Mainak Bandyopadhyay, Arun Kumar Chakraborty

Rotor-dynamic Design Aspects for a Variable Frequency Drive Based High Speed Cryogenic Centrifugal Pump in Fusion Devices

Jotirmoy Das, Hitensinh Vaghela, Ritendra Bhattacharya, Pratik Patel, Vinit Shukla, Nitin Shah, Biswanath Sarkar

Quench Detection, Protection and Simulation Studies on SST-1 Magnets

Aashoo N Sharma, Yohan Khristi, Subrata Pradhan, Kalpesh Doshi, Upendra Prasad, Moni Banaudha, Pankaj Varmora, Bhadrash R Praghi

Gas Fueling System for SST-1

Kalpeshkumar R Dhanani, Ziauddin Khan, Dilip Raval, Pratibha Semwal, Siju George, Yuvakiran Paravastu, Prashant Thankey, Mohammad Shoaib Khan, Subrata Pradhan

Development of Electromagnetic Welding Facility of Flat Plates for Nuclear Industry

Rajesh Kumar, Subhanarayan Sahoo, Biswanath Sarkar, Anurag Shyam

Engineering Design & Integration of Radial Control Coil in Vacuum Vessel of SST-1

Pradeep Chauhan, Prosenjit Santra, Snehal Jaiswal, Prabal Biswas, Kirit R Vasava, Tejas Parekh, Hiteshkumar Patel, Subrata Pradhan

Engineering Design & Integration of In-vessel Single Turn Segmental Coil in Vacuum Vessel of SST-1

Snehal Jaiswal, Pradeep Chauhan, Prosenjit Santra, Kirit R Vasava, Tejas Parekh, Hiteshkumar Patel, Prabal Biswas, Subrata Pradhan

Quality Control of FWC during Assembly/Commissioning on SST-1

Hiteshkumar Patel, Prosenjit Santra, Snehal Jaiswal, Pradeep Chauhan, Yuvakiran Paravastu, Siju George, Gattu Ramesh Babu, Arun Prakash A, Pratibha Semwal, Prashant Thankey, Kalpeshkumar R Dhanani, Dilip Raval, Ziauddin Khan, Subrata Pradhan, Tejas Parekh, Prabal Biswas

Laser Shock Peening of Stainless Steel Surfaces: ns vis-a-vis ps Laser Pulses

Prem Kiran P, Pardhu Yella, Koteswararao V Rajulapati, Venkateshwarlu Pinnoju, Ramesh Kumar Buddu, Bhanu Sankara Rao Kota

Assembly & Metrology of First Wall Components of SST-1

Tejas Parekh, Prosenjit Santra, Prabal Biswas, Hiteshkumar Patel, Yuvakiran Paravastu, Snehal Jaiswal, Pradeep Chauhan, Gattu Ramesh Babu, Arun Prakash A, Dhaval Bhavsar, Dilip Raval, Ziauddin Khan, Subrata Pradhan

Trap Site Formation and their Distribution Studies in Porous Lithium Titanate

Chandan Danani, Manoj Warriar, Paritosh Chaudhuri

Design of a High Power Water Load for LHCD System of SST-1 Tokamak

Harish V Dixit, Aviraj Jadhav, Yogesh M Jain, Alice Cheeran, Vikas Gupta, Pramod K Sharma

Design of Multiple Ferrite Tile Phase Shifters for Applications in High CW Power Differential Phase Shift Circulators

Harish V Dixit, Aviraj Jadhav, Yogesh M Jain, Alice Cheeran, Vikas Gupta, Pramod K Sharma

Conceptual Design of PAM Antenna for Aditya-U Tokamak

Yogesh M Jain, Pramod K Sharma, Jagabandhu Kumar, Harish V Dixit, Kirankumar K Ambulkar, Pramod R Parmar, Chetan G Virani

Assessment of Delta Ferrite in Multipass TIG Welds of 40 mm Thick SS 316L Plates: A Comparative Study of Ferrite Number (FN) Prediction and Experimental Measurements

Ramesh Kumar Buddu, Shamsuddin Shaikh, Prakash M Raole, Biswanath Sarkar

Study of Transients in Liquid Helium Flow during Cool Down of Cryopanel

Reena Sayani, Samiran Shanti Mukherjee, Ranjana Gangradey

A Simple In-vessel/FW Component Viewing System for SST-1

Prosenjit Santra, Prabal Biswas, Kirit R Vasava, Snehal Jaiswal, Tejas Parekh, Pradeep Chauhan, Hiteshkumar Patel, Subrata Pradhan

Overall Behaviour of PFC Integrated SST-1 Vacuum System

Ziauddin Khan, Dilip Raval, Yuvakiran Paravastu, Pratibha Semwal, Kalpeshkumar R Dhanani, Siju George, Mohammad Shoab Khan, Arun Prakash A, Gattu Ramesh, Prashant Thankey, Firozkhan Pathan, Subrata Pradhan

Assembly of Neutral Beam Injector with SST-1

Rambabu Sidibomma, Prahlad Vattipalle, Sanjeev Kumar Sharma, Sridhar B, Laxmi Narayan Gupta, Ujjwal Kumar Baruah

Experience of 12 kA / 16 V SMPS during the HTS Current Leads Test

Pradip Panchal, Dickens Christian, Rohitkumar Panchal, Dashrath Sonara, Gaurav Purwar, Atul Garg, Hiren Nimavat, Gaurav Kumar Singh, Jal Patel, Vipul L Tanna, Subrata Pradhan

Calibration of Low Temperature Measurement System for the Superconducting Magnet System for the SST-1

Bhadresh R Praghi, Yohan Khristi, Subrata Pradhan, Pankaj Varmora, Upendra Prasad



Electronics for Coupled High Voltage Measurement on PF Magnets of SST-1

Moni Banaudha, Yohan Khristi, Subrata Pradhan, Azadsinh Makwana, Upendra Prasad, Devenkuram H Kanabar

Electronics and Instrumentation for the SST-1 Superconducting Magnet System

Yohan Khristi, Subrata Pradhan, Pankaj Varmora, Moni Banaudha, Bhadrash R Praghi, Upendra Prasad

Precision Electronics and Measurement Techniques for the Superconducting Joint Resistance

Yohan Khristi, Subrata Pradhan, Kalpesh Doshi

Preliminary Results from Electron Cyclotron Measurements at SST-1

Varsha Siju, Praveena Kumari, Surya Kumar Pathak

PLATo (Power Load Analysis Tool) – A Module of WEST Wall Monitoring System

Sutapa Ranjan, Jean-marcel Travers, P Moreau, C Balorin, J Bucalossi, V Chaudhari, Y Corre, M Firdaouss, M Jouve, E Nardon, R Nouailletas, N Ravenel, B Santraine

Fabrication of Vacuum Vessel with Detachable Top Lid Configuration for Indian Test Facility (INTF)

Jaydeep Joshi, Ashish Yadav, Dhananjay Kumar Singh, Hiteshkumar K Patel, S Ulahannan, A Vinaykumar, M Girish, M Khan, Mahohar, Chandramouli Rotti, Mainak Bandyopadhyay, Arun Kumar Chakraborty

Measurement and Sweep-biasing Circuit for Langmuir Probe Diagnostic in SYMPLE

Pramila Gautam, Jignesh Patel, Rachana Rajpal, Chandresh Hanasalia, Anitha V P, Krishnamachari Sathyanarayana, Ratneshwar Jha

Density Measurement Systems at SST Tokamak

Umeshkumar C Nagora, Surya Kumar Pathak, Parveen Kumar Atrey

Software Upgradation of PXI Based Data Acquisition for Aditya Experiments

Vipul K Panchal, Chhaya Chavda, Vijay Patel, Narendra Patel, Joydeep Ghosh

Development, Integration and Testing of Automated Triggering Circuit for Hybrid DC Circuit Breaker
Deven Kanabar, Swati Roy, Chiragkumar Dodiya, Subrata Pradhan

Metrology Measurements for Aditya Tokamak Upgradation

Sharvil Patel, Kulav Rathod, Snehal Jayaswal, Pradeep Chauhan, Joydeep Ghosh, Rakesh L Tanna, Prabal K Chattopadhyay, Mohan Parmar, Jinto Thomas, Madan B Kalal, Krishnamachari Sathyanarayana, Mohsin Malek, Pratik Patel, Ramkrushna Panchal, Nilesh Patel

Study of Transport and Micro-structural Properties of Magnesium Di-Boride Strand under React and Bend Mode and Bend and React Mode

Ananya Kundu, Subrat Kumar Das, Anees Bano, Subrata Pradhan

Michelson Interferometer Diagnostics for Broadband ECE Measurement

Abhishek Sinha, Surya Kumar Pathak

Assembly of Aditya Upgrade Tokamak

Madan B Kalal, Rakesh L Tanna, Joydeep Ghosh, Shailesh B Bhatt, Dinesh S Varia, Sharvil Patel, Vaibha Ranjan, Devraj H Sadharkiya, Ramkrushna Panchal, Rohit Kumar, Harshita Raj, Krishnamachari Sathyanarayana, Kulav Rathod, Kumarpalsinh A Jadeja, Kaushal M Patel, Kaushik S Acharya, Prabal K Chattopadhyay, Ashok V Apte, Yogesh C Saxena, Dhiraj Bora, Shell-N-Tube Team

Conceptual Design of Dump Resistor for Superconducting CS of SST-1

Swati Roy, Subrata Pradhan, Arun Panchal

Safety and Environment Aspects of Tokamak-type Fusion Power Reactor - An Overview

Bharatkumar Doshi, D Chenna Reddy

Fusion Blanket Materials Development and Recent R&D Activities

Chandra Sekhar Sasmal, Shiju Sam, Atikkumar N Mistry, Atul Prajapati, Hardikkumar M Tailor, Jignesh P Chauhan, Kinkar Laha, Arun Kumar Bhaduri, Rajendra Kumar E

Electrical Properties of Nano Li_2TiO_3 for Fusion Reactors

S K S Parashar, Kajal Parashar, Paritosh Chaudhuri

Design of New Superconducting Central Solenoid of SST-1 Tokamak

Upendra Prasad, Subrata Pradhan, Mahesh Ghate, Piyush Raj, Vipul L Tanna, Ziauddin Khan, Swati Roy, Prosenjit Santra, Prabal Biswas, Aashoo N Sharma, Yohan Khirsti, Pankaj Varmora

Design of High Resolution Spectroscopic Diagnostics for SST-1 and ADITYA-U Tokamak

Gaurav Shukla, Kajal Shah, Malay Bikas Chowdhuri, Ranjana Manchanda, Santanu Banerjee, Nilam Ramaiya, Joydeep Ghosh

Conceptual & Engineering Design of Plug-in Cryostat Cylinder for Superconducting Central Solenoid of SST-1

Prabal Biswas, Prosenjit Santra, Kirit R Vasava, Snehal Jayswal, Tejas Parekh, Pradeep Chauhan, Hiteshkumar Patel, Subrata Pradhan

Magnetic Probe Diagnostic Tool to Understand the Dynamics in a Non-transferred dc Plasma Torch

Vidhi Goyal, Ravi Ganesh

Localized solutions in Laser Plasma Coupled System with Periodic Time Dependence

Deepa Verma, Amita Das, Bhavesh Patel, Predhiman Krishan Kaw

Coupling of Drift Wave with Dust Acoustic Wave

Atul Kumar, Amita Das, Predhiman Krishan Kaw

Resolving Issues Associated with Langmuir Probe Measurements in High Pressure Complex (Dusty) Plasmas

Manjit Kaur, Sayak Bose, Prabal K Chattopadhyay, Joydeep Ghosh, Yogesh C Saxena

On the Spatial Behavior of Background Plasma in Different Background Pressure in CPS Device

Subrata Samantaray, Rita Paikaray, Gourishankar Sahoo, Parthasarathi Das, Joydeep Ghosh, Amulya Kumar Sanyasi

Relativistic Cylindrical and Spherical Plasma Waves

Arghya Mukherjee, Sudip Sengupta

Breaking of Relativistic Electron Beam Driven Wake Waves in a Cold Plasma

Ratan Kumar Bera, Arghya Mukherjee, Sudip Sengupta, Amita Das

Production of Quiescent Collisionless Plasma over a Wide Operating Range

Sayak Bose, Manjit Kaur, Prabal K Chattopadhyay, Joydeep Ghosh, Yogesh C Saxena

Anode Glow and Double Layer in DC Magnetron Anode Plasma

Samir Chauhan, Mukesh Ranjan, Subroto Mukherjee

Effect of Trapped Particle Nonlinearity in IAW Solitary Wave

Debraj Mandal, Devendra Sharma

Installation of a 100 kJ Pulsed Power System to Drive Pulsed Plasma Devices

Suramoni Borthakur, Nayan Talukdar, Nirod Neog, Tridip Borthakur, Rajesh Kumar, Rishi Verma, Anurag Shyam Shyam

Characterization of the Permanent Magnet Based Hydrogen Helicon Plasma Source for Ion Source Application

Arun Pandey, Dass Sudhir Kumar, Arun Kumar Chakraborty

Parallel Connection Length and Flow-fluctuation Cycle in Simple Toroidal Device

Umesh Kumar, Shekar Goud Thatipamula, Rajaraman Ganesh, Yogesh C Saxena, Raju Daniel

Controllable Location of Polarization Reversal in Nonuniform Helicon Plasma

Sonu Yadav, Prabal K Chattopadhyay, Joydeep Ghosh, Soumen Ghosh

Hot Tungsten Plate Based Ionizer for Cesium Plasma in a Multi-Cusp Field Experiment

Amitkumar D Patel, Meenakshee Sharma, N. Ramasubramanian, Prabal K Chattopadhyay

Development of Three Dimensional Magnetic Field Probe with Signal Conditioning Electronics

Kiran Patel, Narayan Behera, Rajesh Kumar Singh, Ajai Kumar



State of Art Data Acquisition System for Large Volume Plasma Device

Ritesh Sugandhi, Pankaj Srivastava, Amulya Kumar Sanyasi, Prabhakar Srivastav, Lalit Mohan Awasthi, Shibhan Krishna Mattoo, Vijay Parmar, Keyur Makadia, Ishan Patel, Sandeep Shah

Controllable Transition from Positive Space Charge to Negative Space Charge in an Inverted Cylindrical Magnetron

Ramkrishna Rane, Mainak Bandyopadhyay, Mukesh Ranjan, Subroto Mukherjee

Measurement of Electron Energy Probability Function in Weakly Magnetized Plasma

Deiji Kalita, Bharat Kakati, Bipul Kumar Saikia, Mainak Bandyopadhyay, Siddhartha Sankar Kausik

Characteristics of Dust-Density Waves in the Presence of a Floating Cylindrical Object in the DC Discharge Plasma

Mangilal Choudhary, Subroto Mukherjee, Rajaraman Ganesh, Abhijeet Sen

Investigation of Magnetic Drift on Transport of Plasma across Magnetic Field

Parismita Hazarika, Bidyut Das, Monojit Chakraborty, Mainak Bandyopadhyay

Lithium Vapor Density Diagnostics for the PWFA Plasma Source at IPR

Mohandas Kizhupadathu Krishnan, Sivakumaran Valluvadasan, Sneha Singh, Ravi A V Kumar

Turbulent, Megagauss Magnetic Fields in Intense, Ultrashort Laser Pulse Interaction with Solids

Amit D Lad, Gourab Chatterjee, Kevin Schoffler, Prashant Singh, Sudip Sengupta, Predhiman Krishan Kaw, Luis Silva, Amita Das, G Ravindra Kumar

Design and Characterization of Cesium Oven for a Multi-cusp Plasma Device

Meenakshee Sharma, Amitkumar D Patel, Narayan Ramasubramanian

Two Dimensional Imaging of Laser Produced Plasma in Magnetic field

Narayan Behera, Rajesh Kumar Singh, Ajai Kumar

Effect of Ablation Geometry on the Formation of Stagnation Layer in Laterally Colliding Plasmas

Alamgir Mondal, Rajesh K Singh, Ajai Kumar

Enhanced Confinement by Controlling Instability in Toroidal Electron Plasma of SMART-EX-C

Lavkesh Lachhvani, Sambaran Pahari, Manu Bajpai, Prabal K Chattopadhyay, Yogesh Yeole

Study of Phase Space Structures in Driven 1D Vlasov Poisson Model

Pallavi Trivedi, Rajaraman Ganesh

Synchronization dynamics and Arnold tongues for two coupled glow discharge plasma sources

Neeraj Chaubey, Subroto Mukherjee, A.N Sekar Iyengar, Abhijeet Sen

Pulsed Plasma for the Study of Coherent Structure in the Electron Magnetohydrodynamic Regime

Garima Joshi, Ravi Ganesh, Subroto Mukherjee

Study of Defects in Externally Driven Dust Density Waves in Cogenerated Dusty Plasma using Time Resolved Hilbert-Huang Transform

Sanjib Sarkar, Mridul Bose, Subroto Mukherjee

Laser Heated Emissive Probe for Plasma Potential Measurement in Fusion Plasmas

Vara Prasad Kella, Payal Mehta, Joydeep Ghosh, Arun Sarma

Study of Fluctuation Induced Particle Flux in the Background of ETG plasma in LVPD

Prabhakar Srivastav, Lalit Awasthi, Amulya Kumar Sanyasi, Pankaj Srivastava, Ratneshwar Jha, Raghvendra Singh, Predhiman Krishan Kaw

Role of Magnetic Cusp for Multiple Axial Potential Structures (MAPS) Formation

Soumen Ghosh, Pabal K Chattopadhyay, Joydeep Ghosh, Dhiraj Bora

DAQ System for Low Density Plasma Parameters Measurement

Rashmi S Joshi, Suryakant B Gupta

Modeling of Electromagnetic Fields during Plasma Startup in SST-1 Tokamak

Amit Kumar Singh, Indranil Bandyopadhyay, Srinivasan Radhakrishnana, SST-1 Team

- Development of a 3D-3V PIC code to study PSI processes in Tokamak Divertor Region
Sayan Adhikari, Kalyan Sindhu Goswami
- Particle in Cell Simulations of Beam Plasma System
Chandrasekhar Shukla, Atul Kumar, Bhavesh Patel, Amita Das, Kartik Patel
- PIC Modeling of Negative Ion Extraction from Dust-Seeded Plasma
Ananya Phukan, Pranjal Bhuyan
- Dynamics of dusty fluid in a streaming sheared plasma
Modhuchandra Laishram, Devendra Sharma, Predhiman Krishan Kaw
- Current Gradient Modes of Two Dimensional Electron Magnetohydrodynamics (EMHD)
Gurudatt Gaur, Predhiman Krishan Kaw
- A Poynting like Theorem for Generalized Hydrodynamic Equations
Vikram Singh Dharodi, Bhavesh Patel, Amita Das, Predhiman Krishan Kaw
- Identification of Nonlinear Resonance Absorption in a Laser Driven Deuterium Cluster using Molecular Dynamics Simulation
Sagar Sekhar Mahalik, Mrityunjay Kundu
- 1D PIC simulation of relativistic Buneman instability
Roopendra Singh Rajawat, Sudip Sengupta
- Molecular Dynamics Simulation of Dust Particle Levitation in the Presence of Sheath
Sandeep Kumar, Amita Das, Sanat Kumar Tiwari, Predhiman Krishan Kaw
- Potential around a dust grain in collisional plasma
Rakesh Moulick, Kalyan Sindhu Goswami
- Numerical simulation of a novel non-transferred arc plasma torch operating with nitrogen
Gavisiddayya Hiremath, Ramachandran Kandasamy, Ravi Ganesh
- Sensitivity analysis of upstream plasma condition for SST-1 X-divertor configuration with SOLPS
Himabindu Manthena, Anil K Tyagi, Deepti Sharma, Devendra Sharma, Srinivasan Radhakrishnana
- Real-time Horizontal Position Control for Aditya-Upgrade Tokamak
Rohit Kumar, Joydeep Ghosh, Rakesh L Tanna, Praveen Lal, Prabal K Chattopadhyay, Chhaya Chavda, Vipul K Panchal, Vijay Patel, Chet Narayan Gupta, Raju Daniel, Aditya Team
- Design & Development of Amplitude and Phase Measurement of RF Parameter with Digital I-Q De-Modulator (DIQDM) Technique using PXI System
Dipal Soni, Rajnish Kumar, Sriprakash Verma, Hriday Patel, Rajesh Trivedi, Aparajita Mukherjee
- Effect of Geometrical Imperfection on Buckling Failure of ITER VVPSS Tank
Saroj Kumar Jha, Girish Kumar Gupta, Manish Kumar Pandey, Avik Bhattacharya, Gaurav Jogi, Anil Kumar Bhardwaj
- Nuclear Analyses of Indian LLCB Test Blanket System in ITER
H L Swami, Akshaya Kumar Shaw, Chandan Danani, Paritosh Chaudhuri
- Preferential Binding of Self-interstitial Atoms over Vacancies to Grain Boundaries of Tungsten: A Lattice Statics Study
Prithwish K Nandi
- Alternate Design of ITER Cryostat Skirt Support System
Manish Kumar Pandey, Girish Kumar Gupta, Anil Kumar Bhardwaj, Saroj Kumar Jha
- Neutronics Analysis, Shielding Optimization and Radiation Waste Analysis for X-Ray Crystal Spectrometer of ITER
P V Subhash, Gunjan Indauliya, Sai Chaitanya Tadepalli, Shrichand Jakhar, Sanjeev Varshney, Siddharth Kumar, K Raja Krishna, Nirav Bhaliya, Robin Barnsley, Bernascolle Phillipe, Shrishail B Padasalagi, Sapna Mishra and Vinay Kumar
- Preliminary Optical Design of Polarization Splitter Box for ITER ECE Diagnostic System



Ravinder Kumar, Suman Danani, Hitesh Kumar Pandya, Vinay Kumar

Development of High Voltage and High Current Test Bed for Transmission Line Components

Akhil Jha, Manojkumar Patel, J V S Harikrishna, Ajesh P, Rohit Anand, Rajesh Trivedi, Aparajita Mukherjee

Development of Control System for Multi-converter High Voltage Power Supply using Programmable SoC

Rasesh Dave, Jagruti Dharangutti, N P Singh, Aruna Thakar, Hitesh Dhola, Sandip Gajjar, Darshan Kumar Parmar, Tanish Zaveri, Ujjwal Kumar Baruah

Development and Validation of I-Activation Analysis Code

Sai Chaitanya Tadepalli, P V Subhash, Gunjan Indauliya

Indigenous Manufacturing Realization of Twin Source and its Auxiliary System

Ravi Pandey, Mainak Bandyopadhyay, Deepak Parmar, Ratnakar Kumar Yadav, Himanshu Tyagi, Jignesh Soni, Hardik Shishangiya, Dass Sudhir Kumar, Sejal Shah, Gourab Bansal, Kaushal Pandya, Kanubhai Parmar, Mahesh Vuppugalla, Agrajit Gahlaut, Arun Kumar Chakraborty

Wilkinson Type Lumped Element Combiner-Splitter for Indigenous Amplifier Development

Manojkumar Patel, Akhil Jha, J V S Harikrishna, Rajesh Trivedi, Aparajita Mukherjee

Preliminary Design Development of ITER X-ray Survey Spectrometer

Sanjeev Varshney, Siddharth Kumar, Sapna Mishra, Subhash Puthenveetil, Kuashal Joshi, Shivakant Jha, Vinay Kumar, Robin Barnsley, Philippe Bernascolle, Gunter Bertschinger, Stefan Simrock, Jean-Marc Drevon, and Michael Walsh

Integration & Validation of LCU with Different Sub-systems for Diacrode Based Amplifier

Rajnish Kumar, Sriprakash Verma, Dipal Soni, Hriday Patel, Gajendra Suthar, Hrushikesh Dalicha, Hitesh Dhola, Amit Patel, Dishang Upadhyay,

Akhil Jha, Manojkumar Patel, Rajesh Trivedi, Raghuraj Singh, Harsha Machchhar, Aparajita Mukherjee

Comparative Analysis on Flexibility Requirements of Typical Cryogenic Transfer Lines

Mohit Jadon, Uday Kumar, Ketan Choukekar, Nitin Shah, Biswanath Sarkar

Dynamics of Cold Helium Flow inside a Cryoline used for Large Cryogenic Distribution System

Uday Kumar, Mohit Jadon, Ketan Choukekar, Vinit Shukla, Pratik Patel, Himanshu Kapoor, Nitin Shah, Srinivasa Muralidhara, Biswanath Sarkar

Final Configuration with Assembly Assessment of the 100kV High Voltage Bushing for the Indian Test Facility

Dheeraj Kumar Sharma, Sejal Shah, M Venkata Nagaraju, Mainak Bandyopadhyay, Chandramouli Rotti, Arun Kumar Chakraborty

Preliminary Design of O-mode Radiometer for ITER ECE Diagnostic

Suman Danani, Hitesh Pandya, Ravinder Kumar, Max E Austin, Victor S Udintsev, Vinay Kumar

System Upgradation for Surface Mode Negative Ion Beam Extraction Experiments in ROBIN

Kaushal Pandya, Gourab Bansal, Jignesh Soni, Agrajit Gahlaut, Ratnakar Kumar Yadav, Mahesh Vuppugalla, Himanshu Tyagi, Kanubhai Parmar, Hiren Mistri, Jignesh Bhagora, Bhavesh K Prajapati, Kartik J Patel, Manar Bhuyan, Mainak Bandyopadhyay, Arun Kumar Chakraborty

Thermo-mechanical Design Methodology for ITER Cryo-distribution Cold Boxes

Vinit Shukla, Pratik Patel, Hiten Vaghela, Jotirmoy Das, Nitin Shah, Ritendra Bhattacharya, Hyun-sik Chang, Biswanath Sarkar

Preliminary Design of Bellows for the DNB Beam Source by EJMA & FE Linear Analysis

Shobhit Trapasiya, Venkata Nagaraju Muvvala, Rambilas P, Dheeraj Kumar Sharma, Roopesh Gangadharan, Chandramouli Rotti, Arun Kumar Chakraborty

Evolving the Inspection Techniques for

determination of Volumetric Dimensions of Ground Pore in Heat Transfer Elements

Hitesh Kumar Kantilal Patel, Jainish Topiwala, Kedar Bhope, Alpesh Patel, Chandramouli Rotti, Arun Kumar Chakraborty

Significance of ITER IWS Material Selection and Qualification

Bhoomi K Mehta, Haresh A Pathak, Gurlovleen Singh Phull, Rahul Kumar Laad, Abha Maheshwari, Jigar Raval

ITER ECE Diagnostic: Design Progress of IN-DA and its Role for Physics Study

Hitesh Kumar Pandya, Ravinder Kumar Jakhmola, Suman Danani, Shrishail B Padasalagi, Sajal Thomas, Vinay Kumar, G Taylor, A Khodak, W L Rowan, S Houshmandyar, V S Udintsev, N Casal, M Walsh

Manufacturing Experience of an 'Angled' Accelerator Grid for DNB Beam Source

Jaydeep Joshi

Preparation and Analysis of Helium Purge Gas Mixture to be used in Tritium Extraction System of LLCB TBM

V Gayathri Devi, Deepak Yadav, Amit Sircar

Seismic Design of ITER Component Cooling Water System-1 Piping

Aditya Prakash Singh, Mahesh Jadhav, Lalit Kumar Sharma, Dinesh Kumar Gupta, Nirav Patel, Rakesh Ranjan, Guman Gohil, Hirenkumar A Patel, Jinendra Dangi, Mohit Kumar, A G Ajith Kumar

Role of Outgassing of ITER Vacuum Vessel In-Wall Shielding Materials in Leak Detection of ITER Vacuum Vessel

Abha Maheshwari, Haresh A Pathak, Bhoomi K Mehta, Gurlovleen Singh Phull, Rahul Laad, Moin Shaikh, Siju George, Kaushal Joshi, Ziauddin Khan
Manufacturing and Assembly of IWS Support Rib and Lower Bracket for ITER Vacuum Vessel
Rahul Laad, Yatin Sarvaiya, Haresh A Pathak, Raval Jigar, Chang-ho Choi

Finite Element Analysis for ITER Ferromagnetic In-wall Shielding Block

Moinuddin Shaikh, Haresh A Pathak, Raval Jigar, Tailhardat Oliver

Development of XM-19 Fasteners for the IWS Blocks Assemblies

Sunil Dani, Gurlovleen Singh, Haresh A Pathak, Jigar Raval, Chang-ho Choi

Pesticides Removal from Cabbage using Array of Atmospheric Pressure Plasma Jet

Akshay Vaid, Chirayu Patil, Ramkrishna Rane, Subroto Mukherjee, Sudhir Nema, Hetal Bhatt, R V Prasad

Comparison of Gas and Plasma Carburizing of AISI 8620 Low Carbon Steel

Alphonsa Joseph, Ghanshyam Jhala, Akshay Vaid, Suryakant Gupta, Keena Kalaria, Naresh Vaghela, Subroto Mukherjee

Experimental Study to Improve Anti-felting Characteristics of Merino Wool Fiber by

Atmosphere Pressure Air Plasma
Nisha Chandwani, Purvi Deva, Vishal Jain, Sudhir Nema, Subroto Mukherjee

Surface Chemistry and Wettability Study of Air Plasma Treated Polyethylene by Atmospheric Pressure Dielectric Barrier Discharge

Purvi Deva, Nisha Chandwani, Vishal Jain, Sudhir Nema, Subroto Mukherjee

Electrical Characteristics of a DC Non-transferred Arc Plasma Torch Using Theory of Dynamic Similarity

Yugesh V, Ravi Ganesh, K Ramachandran

Design and Development of 20 kW, 45 kV, 30 kHz Power Supply for Study of Pulsed Dielectric Barrier Discharges

Surender Kumar Sharma, Anurag Shyam

Plasma Sterilization for Bio-decontamination

Suryakant Gupta, Sudhir Nema

Simulation and Modeling of Magnetic Field Dynamics in Laser Plasma Interaction

Amita Das, Chandrashekhhar Shukla, Atul Kumar, Bhavesh Patel, Predhiman Krishan Kaw

Spectroscopy of Laterally Colliding Plasma Plumes in Laser-blow-off of Thin Film: Role of Energetic



Neutrals in Formation of Interaction Zone
Ajai Kumar, Bhupesh Kumar, Rajesh Kumar Singh

Thermionic Divertors for Tokamaks
Avinash Khare, Sanjay K Mishra, Predhiman
Krishan Kaw

Modeling of ITER Disruption scenarios using TSC
Indranil Bandyopadhyay, Amit K Singh

Technical Developments and Present Status of the
ITER Cryolines and Cryo-distribution Systems
Biswanath Sarkar, Nitin Shah, Hitensinh Vaghela,
Ketan Choukekar, Pratik Patel, Himanshu Kapoor,
Srinivasa Muralidhara, Jotirmoy Das, Uday Kumar,
Anuj Garg, Vinit Shukla, Mohit Jadon, Vikas Gaur,
Bikash Dash, Shk Madeenavalli

Upgradation Plans of SST-1 Cryogenics System at
IPR
Vipul L Tanna, SST-1 Cryo Team, Subrata Pradhan

Indian Test Facility (INTF) - The Indian contribution
to R&D on ITER Neutral Beams
M. Bandyopadhyay

**Indian Particle Accelerator Conference
(InPAC-2015), Tata Institute of Fundamental
Research, Colaba, Mumbai, 21-24 December
2015**

Design of Radio Frequency Quadrupole (RFQ) - A
front end injector for accelerators at IPR
Renu Bahl, B. Sarkar, M. Mittal, S. Kumar and A.
Shyam

Beam Dynamics and Design Studies of a Low
Energy Beam Transport (LEBT) System for 1
MEV Radio Frequency Quadrupole (RFQ) at IPR
M. Mittal, R. Bahl, S. Kumar, B. Sarkar, A. Shyam

Optimization of Mechanical design of Radio
Frequency Quadrupole (RFQ) using CST
Microwave Studio
S. Kumar, R. Bahl, B. Sarkar, A. Shyam and M.
Mittal

PWFA plasma source - Interferometric diagnostics
for Li vapor density measurements
V. Sivakumaran, K.K. Mohandas, Sneha Singh and

Ravi A.V. Kumar

Surface flashover diagnostic facility for irradiated
satellite solar cells by charged particles
Suryakant B. Gupta, Keena R. Kalaria, Naresh P.
Vaghela, Rashmi S. Joshi, S. Mukherjee, Uma B.R.,
Usha G., G. Krishna Priya, Suresh E. Puthanveetil,
M. Sankaran, Kavita Dixit, Shrikrishna Gupta

An updated instrumentation system for the study
of electrostatic discharges on satellite solar panel
coupons in laboratory
Suryakant B. Gupta, Keena R. Kalaria, Naresh P.
Vaghela, Rashmi S. Joshi, S. Mukherjee, Suresh
E. Puthanveetil, M. Sankaran and Ranganath S.
Ekkundi

**60th DAE Solid State Physics Symposium, Amity
University, Noida, 21-25 December 2015**

Thermal Impedance Measurement of Conduction
cooled Current Lead joint block used in Cryocooler
based Self-field I-V Characterisation Facility
Ananya Kundu, Subrat Kumar Das, Anees Bano,
Pooja Agarwal, Subrata Pradhan

**International Conference on Plasma Science
Technology and Application (ICPSTA 2016),
Amity University, Lucknow, 20-21 January 2016**

Wave Breaking in a Maxwellian Plasma
Arghya Mukherjee and Sudip Sengupta

The microstructure and mechanical properties of
Ti/TiN multilayer film synthesized by magnetron
sputtering deposition on SS316L
K.Shukla, R.Rane, A. Joseph, P. Maity, S.
Mukherjee

The microstructure and mechanical properties of
Ti/TiN multilayer film synthesized by magnetron
sputtering deposition on SS316L
K.Shukla, R.Rane, A. Joseph, P. Maity, S. Mukherjee

**7th International Conference on Creep, Fatigue
and Creep-Fatigue Interaction (CF-7), Indira
Gandhi Centre for Atomic Research, Kalpakkam,
19-22 January 2016**

Influence of Pico-second Laser Shock Peening on the microstructure and fatigue behaviour of 316L(N) stainless steel

Pardhu Yella, Venkateswarlu Pinnoju, Prem Kiran Pathuri, Koteswararao V.Rajulapati, G.V. Prasad Reddy, A. Nagesha, R. Sandhya, N. Ravi, Ramesh Kumar Buddu, PM Raole, K. Bhanu Sankara Rao

International Conference on Internet of Things and Applications (IOTA 2016), Pune, 22-24 January 2016

IOT Application for Real Time Monitor of PLC Data using EPICS

Ramesh Joshi, H.M. Jadav, Anirudh Mali and S.V. Kulkarni

61st Annual Technical Session of Assam Science Society, Goalpara College, Assam, India, 23 January 2016

Particle charging in low pressure plasma

D. Kalita, B. Kakati, S.S.Kausik and B.K. Saikia

22nd ITPA Divertor and Scrape-Off Layer TG Meeting, ENEA, Frascati, Italy, 25-28 January 2016

Heat-flux scale length analysis for ring limiter generated SOL in Tokamak ADITYA

Richard Pitts, D. Sharma, Bibhu P. Sahoo, Santosh P. Pandya, Shwetang N. Pandya, Kumar Ajay, J. Govindarajan, R. Jha, R. L. Tanna, S. B. Bhatt, K. A. Jadeja, Kaushal Patel, Joydeep Ghosh & Aditya Team

Advances in Refractory and Reactive Metals and Alloys (ARRMA 2016), Multipurpose Hall, Training School Hostel, Anushaktinagar, Mumbai, India, 27-29 January 2016

Study of Diffusion Bonding of WL10 to SS Joining with & without Titanium Interlayer using Thermo Mechanical Simulator

K.P Singh, Alpesh Patel, Kedar Bhope, Nikunj Patel, S.S Khirwadkar

17th Asian Pacific Corrosion Control Conference (APPCC), IIT Bombay, Mumbai, India, 27-30 January 2016

Study of Plasma Nitriding and Nitrocarburizing of AISI 430F Stainless Steel for High Hardness and Corrosion Resistance

J. Alphonsa, S. Mukherjee, V.S. Raja

3rd International Conference on Innovations in Automation and Mechatronics Engineering (ICIAME2016), GH Patel College of Engineering & Technology, Vallabh Vidyanagar, Gujarat, 5-6 February 2016

Multi Physics simulation of Laser Cladding Process to study the effect of process parameters on clad geometry

Ravi Parekh, Ramesh Kumar Buddu, and R.I. Patel

Innovation in Mechanical, Automobile, Civil Engineering & Materials Technology, Indus University, Ahmedabad, 13 February 2016

Surface Modification of 17-4PH Stainless Steel by Plasma Nitriding

Sangita Jadeja, B. Ganguli, and D.K. Basa

Enhancement of Surface Properties of Maraging Steel C300 by Plasma Nitriding

Nand Kumar, B. Ganguli, and S. Sharma

Feasibility study of nickel based coating on LM-25 aluminium alloy

Pooja Shah, Vaibhav Bhavsar, Murnalkumar Chaudhary, Nirav Jamnapara

International Conference on Powder Metallurgy & Particulate Materials (PM-16) by Powder Metallurgy Association of India, Pune, 18-20 February 2016

Synthesis and Characterization of Nano-Crystalline Magnesium Aluminate Spinel Powder by Sol-Gel Process

Akash Shah, C. Jariwala, R. Pillai, S. B. Tandon, P. M. Raole and B. Sarkar

Preparation and Characterization of Nano-Crystalline α -Al₂O₃ Powder by Sol-gel Process

V. Rathod, C. Jariwala, R. Pillai, and D. K. Basa

Materials Research Society of India (MRSI)

Symposium, CSIR-North East Institute of Science and Technology, Assam, India, 18-20 February 2016

Studies on interaction of a High Heat Flux Plasma beam with material targets and the recent status of the development of CIMPLE-PSI

Trinayan Sarmah, N. Aomoa, B. Satpathi and M. Kakati

International Conference on Materials Science and Technology (ICMTech 2016), University of Delhi, Delhi, 1-4 March 2016

Influence of pH on Sol-Gel Derived Silica Nano-Particles for Various Applications in Nano-Composites

Sumit Kumar, C. Jariwala, R. Pillai, Deepak Rawtani and Y. K. Agrawal

IEEE International Conference on Electrical, Computer and Communication Technologies (ICECCT 2015), Coimbatore, India, 5-7 March 2015

Engineering Design of Labview Based Prototype Software Development for 45.6 MHz, 100 kW ICRH DAC System

Anirudha Mali, Ramesh Joshi, H.M. Jadav, Krupa Mehta and S.V. Kulkarni

Integration of MODBUS/TCP master monitoring and control system using python for High Power RF System

Krupa Mehta, Ramesh Joshi, H.M. Jadav, S.V. Kulkarni and Bhavesh H. Soni

EPICS Based Prototype CLIENT for ICRH DAC
Ramesh Joshi, Manoj Parihar, H M Jadav & S.V. Kulkarni

26th International Cryogenic Engineering Conference and International Cryogenic Material Conference 2016 (ICEC26-ICMC2016), Manekshaw Centre, New Delhi, 7-11 March 2016

Design of 3-stream (He-He-He) compact plate-fin heat exchanger for helium plant

A. K. Sahu, O. Mahapatra, P Sharma, B. V. Shah, R. K. Sahoo

Finding friction factor for low temperature helium flow through serrated type plate-fin heat exchanger using CFD

B V Shah, A K Sahu, N Mamgain, S V Jain and P Sharma

Effects of charcoal particle and bed size for design of helium gas purification system at 20 K for helium plant

D. G. Bohra, A K Sahu, A. Behera, D. Prajapati

Design of expansion wheel with backward swept blade for low temperature helium expansion turbine and CFD analysis results

Sourabh Jogee, A K Sahu, R K Sahoo, Ronak Shah, V Patel, B V Shah

Design, analyses, fabrication and characterization of Nb3Sn coil in 1 W pulse tube cryocooler

Ananya Kundu, Subrat Kumar Das, Anees Bano, Nitish Kumar and Subrata Pradhan

Assembly Installation studies for the ITER cryoline system

S. Badgujar, N. Shah, A. Forgeas, N. Navion-Maillot, E. Monneret, D Grillot and B Sarkar

Experimental results of ITER cold circulators towards the performance demonstration

R Bhattacharya, H Vaghela, B Sarkar, P Patel, J Das, M Srinivasa, T Isono and K Kawano

Design of ITER Relief Lines

N. Shah, K. Choukekar, M. Jadon, B. Sarkar, B. Joshi, H. Kanzaria, V. Gehani, H. Vyas, U. Pandya, R. Panjwani, S. Badgujar, E. Monneret

Status of ITER Cryo-distribution and Cryoline project

B Sarkar, H Vaghela, N Shah, R Bhattacharya, K Choukekar, P Patel, H Kapoor, M Srinivasa, H S Chang, S Badgujar and E Monneret

Acceptance tests and their results for 1st Pre-Series Cryoline (PTCL) of ITER

H. Kapoor, A. Garg, N. Shah, S. Muralidhara, K. Choukekar, B. Dash, V. Gaur, S. Madeenavalli, P. Patel, U. Kumar, M. Jadon, V. Shukla, B. Sarkar, Y. Sarvaiya, D. Mukherjee, A. Dutta, KV. Murugan,

S. Gajera, B. Joshi, R. Panjwani

Cryogenic Heat loads analysis from SST-1 plasma experiments

N. Bairagi, V. L. Tanna and S. Pradhan

Process optimization of helium cryo plant operation for SST-1 superconducting magnet system

P. Panchal, R. Panchal, R. Patel, G. Mahesuriya, D. Sonara, L. N. Srikanth G., A. Garg, D. Christian, N. Bairagi, R. Sharma, K. Patel, P. Shah, H. Nimavat, G. Purwar, J. Patel, V. Tanna and S. Pradhan

Installation and commissioning of 80 K liquid nitrogen booster system for SST-1

R. Patel, G. Mahesuriya, GLN Srikanth, D. Christian, K. Patel, P. Shah, H. Nimavat, P. Panchal, R. Panchal, D. Sonara, J. C. Patel, V. L. Tanna and S. Pradhan

System for adsorption isotherm studies of porous carbon materials Down to 4.5 K

J. Mishra, J. Agarwal, S. Mukherjee, P. Nayak, P. Panchal, S. Kasthuriangan, V. Lambade and R. Gangradey

The validation tests of fusion grade superconductors

U. Prasad, S. Pradhan, P. Raj, P. Varmora, A. Panchal, A. Bano, M. Ghate and Magnet division

Status of the ITER cryodistribution design and component configuration

H.-S. Chang, A. Forgeas, M. Clough, E. Fauve, H. Vaghela, R. Bhattacharya, B. Sarkar

Design and analysis for adoption of oil injected air screw compressor and oil removal system for compression of Helium gas

N. Gupta, J. Patel, P. Nema, Y. Joshi, A. K. Sahu
Design & development of liquid nitrogen based pre-cooler for solid hydrogen extruder
P. Nayak, S. Mukherjee, P. Panchal, D. Tripathi, R. Gangradey, J. Mishra, J. Agarwal

Design and manufacturing of 30 kA Nb₃Sn CICC for fusion relevant superconducting magnet

P. Raj, M. Ghate, A. Singh, S. Pradhan, M. M. Hussain, K. K. Abdulla

Upgradation of integrated flow distribution and control (IFDC) system for SST-1

R. Panchal, GLN Srikanth, K. Patel, P. Shah, P. Panchal, V. L. Tanna and S. Pradhan

Journey towards realization of fusion reactor grade cryopump & related technologies in India

Ranjana Gangradey, Samiran Mukherjee, Jyoti Agrawal, Paresh Panchal, Pratik Nayak, J. S. Mishra, S. Udgate, S. Kasthuriangan, V. S. Tripathi

Warm and cold acceptance tests and their results for 1st pre-series cryoline (PTCL) of ITER

Himanshu Kapoor, Anuj Garg, Nitin Shah, Srinivasa M, Vikas Gaur, Bikash Dash, Shk Madeenavalli, Mohit Jadon, Pratik Patel, Ketan Choukekear, and Biswanath Sarkar

Pump characterization of 80 K liquid nitrogen booster system for SST-1

G. Mahesuriya, R. Patel, V. L. Tanna and S. Pradhan

Performance of superconducting current feeder system for SST-1

A. Garg, H. Nimavat, P. Shah, K. Patel, D. Sonara, GLN Srikanth, N. Bairagi, D. Christian, R. Patel, G. Mahesuriya, R. Panchal, P. Panchal, R. Sharma, G. Purwar, V. L. Tanna and S. Pradhan

5th International Conference on Materials Processing and Characterization (ICMPC), GRIET, Hyderabad, 12-13 March 2016

Multipass Welding on Inconel Material with Pulsed Current Gas Tungsten Arc Welding

Vemanaboina Harinadh, G. Edison, Suresh Akella, L. Sanjeeva Reddy, Ramesh Kumar Buddu

ITPA Pedestal and Edge Physics Topical Group meeting, IPR, Gandhinagar, 16-18 March 2016

Overview of Indian activities in P&EP
Santanu Banerjee, N. Bisai, D. Chandra, L. Lachhvani, J. Ghosh, P. Dhyani, D. Sharma, A. Sen, P. K. Kaw, A. Thayagaraja

Observation of quasi-coherent edge fluctuations and L-H transitions dynamics in NSTX Ohmic plasmas

Santanu Banerjee, A. Diallo, S. J. Zweben and T. Stoltzfus-Dueck

PATENT APPLIED

Atmospheric Pressure Plasma Jet for Bio-Medical applications

Akshay Vaid, Chriayu Patil, Adam Sanghariyat, Ramakrishna Rane, Abhijit Majumdar, Subrato Mukherjee

Indian Provisional Patent Application number: 3727/MUM/2015

Plasma Pyrolysis System and Process for the disposal of Waste using graphite plasma torch

K.S. Ganesh Prasad, S. K. Nema, V. Jain

Patent Number: 272122 dated 18/03/2016

AWARDS and ACHIEVEMENTS

Ms. Akanksha Gupta, Research Scholar from Institute for Plasma Research, received the best poster award at 7th International Conference on the Frontiers of Plasma Physics and Technology, Kochi, Kerala, 13-17 April 2015. This award had a cash prize of Rs. 9000 and a citation from the Journal of Laser & Particle Beams

Dr. Subrata Pradhan (Scientist-H) has been conferred the prestigious 'Scientific Research Council Out-standing Investigator Awardee' of the Department of Atomic Energy (DAE-SRC OI) for 2014 in response to his research proposal and in recognition to his outstanding contributions to plasma sciences and technologies. Under this award, Dr. Pradhan will be receiving an additional monthly incentive of INR 25000 for a period of five years as well as a research grant sum totaling up to Rs. 1 Crore over the same period towards carrying out research and development activities.

Dr. Amita Das, Senior Professor H+, was elected as FELLOW, by the National Academy Of Sciences, India in 2015 for her outstanding contribution towards scientific research.

Dr. Mainak Bandyopadhyay of DNB Group, ITER-India, received a certificate of appreciation from the Editorial Board of the Journal of Fusion Engineering and Design (Elsevier) as an Outstanding Reviewer for the Journal in the year 2015.

Mr. Ramesh Kumar Buddu, Scientist-SF, received **Best Reviewer certificate** from the Journal of Fusion Engineering and Design

Mr. Ritesh Sugandhi, Engineer-SF from the Basic Plasma Science Group has been certified by National Instruments as a Certified LabVIEWTM Associate Developer (CLAD) on 24-Aug-2015. He is currently the only member from IPR, Gujarat, listed on the National Instruments website in the community

Shri Bharat Doshi of the Mechanical Services Division, IPR, received a certificate of appreciation from the Editorial Board of the Journal of Fusion & Engineering Design (Elsevier) as an Outstanding Reviewer for the Journal in the year 2015.

Subramanyan Chandrasekhar Prize of Plasma Physics was awarded to Prof. Predhiman K. Kaw, selected as Laureate of 2015, by Division of Plasma Physics (DPP), Association of Asia Pacific Physical Societies (AAPPS), partially sponsored by Future Energy Research Association, to a scientist who has made seminal / pioneering contribution in the field of plasma physics. For his seminal contributions in the areas of laser-plasma interactions, turbulence, nonlinear effects in magnetic fusion devices and strongly coupled dusty plasmas.

IPR (TBM Group) & IGCAR (Materials Group) was jointly conferred with the **DAE Group Achievement Award (2014-15)** for the joint group activity titled "Development of Indian Reduced Activation Ferritic Martensitic (IN-RAFEM) Steel for India's Test Blanket Module (TBM) Program in ITER". This award was conferred in recognition of this Group's outstanding contributions to the Departmental programme under DAE (Excellence in Science, Engineering and Technology) Award Scheme. In view of this, a small function was arranged at IPR Seminar Hall to felicitate the team members from IPR for this DAE Group Achievement Award. There were 31 members in the group consisting of IGCAR and IPR team, of which eight members were from IPR. The team from IPR comprised of Chandra Sekhar Sasmal, Shiju Sam, Atikkumar N Mistry, Narender Singh, Atul Kumar Prajapati, Jignesh Chauhan and

Hardik Tailor who worked under the leadership of Shri. E. Rajendrakumar. The award consists of a total cash amount of Rs. 60,000/- in addition to memento and citation for group leader and each individual team member. During the function Director, IPR distributed the memento and citation. The Director while congratulating the team said that this function was organised so that it could excite and motivate other groups in IPR. Professor Kaw also congratulated the whole group for their achievement. Shri. E. Rajendra Kumar, Apex-3 leader, took the opportunity to thank Prof. P.K. Kaw, Prof. D. Bora, the technical staff as well non-technical staff of IPR and IGCAR for their constant support.

A Multiphysics investigation of RF Dry Loads
Yogesh M. Jain, Aviraj R. Jadhav, Harish V. Dixit, Alice N. Cheeran, Vikas N. Gupta, P. K. Sharma won **Best Paper Award** at IEEE Bombay Section Symposium 2015, SNDT College, Mumbai, India, 10-11 September 2015

Dr. Shantanu Karakari was **awarded honorary associate** in the Electrical and Electronics Engineering Department, University of Liverpool, U.K. during 26th September 2015 to 30th December 2015

Dr. Nirav I. Jamnapara received the **Young Researcher Award** at the International Surface Engineering conference at NCR Delhi on 8th October 2015. The award comprising of a Gold Plated Plaque along with a cash prize of Rs. 11,000/- was sponsored by Kansai Nerolac Paints Ltd. and issued by Society for Surface Protective Coatings, India.

Quality Evaluation of CuCrZr to SS Diffusion joints using Ultrasonic C-scan imaging Technique
Kedar Bhope, K P Singh, Alpesh Patel, Mayur Mehta and S.S. Khirwadkar won **1st Prize for best Poster Presentation** at National Conference on Non Destructive Testing-2015 (NDE-2015) Hyderabad, 26-28 November 2015

A Pin-Plane Probe Method to Determine Plasma Parameters in Magnetized Discharges
S. Binwal, S. Gandhi, H. Kabariya and S. K.

Karkari won **Best Poster Award** at 30th National Symposium on Plasma Science & Technology (Plasma-2015), Saha Institute of Nuclear Physics, Kolkata, India, 1-4 December 2015

Effect of multiple Gas-puffs on Plasma density and temperature in Aditya tokamak Harshita Raj, Joydeep Ghosh, R.L. Tanna, K.A Jadeja P.K. Chattopadhyay, D. Raju, S. K. Jha, J. Raval, S. Joisa, S. Purohit, CVS Rao, P. K. Atrey, Umesh Nagora, S.K. Pathak, R. Manchanda, M. B. Chowdhuri, Nilam Ramaiya, S. Banerjee, Y.C. Saxena and Aditya team won **Z. H. Sholapurwala Best Poster Presentation Award** for fusion research at 30th National Symposium on Plasma Science & Technology (Plasma-2015), Saha Institute of Nuclear Physics, Kolkata, India, 1-4 December 2015

Study of weld defect behavior under the operational conditions of Heat Transfer Element: First phase
Jainish Topiwala, Hitesh Patel, Kedar Bhope, Alpesh Patel, Chandramouli Rotti, Arun Chakraborty won **Z. H. Sholapurwala Award** for fusion research at 30th National Symposium on Plasma Science & Technology (Plasma-2015), Saha Institute of Nuclear Physics, Kolkata, India, 1-4 December 2015

Development of 12inch Gas Barrier Assembly for Cooling of Transmission Line Components
Akhil Jha, Rohit Anand, Ajesh P., Paresh Vasava, Rajesh Trivedi, and Aparajita Mukherjee won **Z. H. Sholapurwala Award** for fusion research at 30th National Symposium on Plasma Science & Technology (Plasma-2015), Saha Institute of Nuclear Physics, Kolkata, India, 1-4 December 2015

Neutronic Performance Optimization Study of Indian Fusion DEMO Reactor First Wall & Breeding Blanket
H L Swami, C Danani won **Second Prize of the PSSI- Z. H. Sholapurwala Award** for Fusion Research at 30th National Symposium on Plasma Science & Technology (Plasma-2015), Saha Institute of Nuclear Physics, Kolkata, India, 1-4 December 2015

Launching of Diocotron Mode in Toroidal Electron

**Plasma Experiment: Smartex-C**

Lavkesh T. Lachhvani, Sambaran Pahari, Manu Bajpai, Yogesh Yeole, Prabal Chattopadhyay won **Best Poster Award** at 30th National Symposium on Plasma Science & Technology (Plasma-2015), Saha Institute of Nuclear Physics, Kolkata, India, 1-4 December 2015

Relativistic Motion of a Charged Particle in a Plane Polarized Light Propagating along a Constant Magnetic Field

Shivam Kumar Mishra and Sudip Sengupta won **Best Poster Award** at 30th National Symposium on Plasma Science & Technology (Plasma-2015), Saha Institute of Nuclear Physics, Kolkata, India, 1-4 December 2015

Neutral Drag Force Measurements in a Flowing Complex Plasma

Surabhi Jaiswal, P. Bandyopadhyay, and A. Sen won **Best Poster Award** at 30th National Symposium on Plasma Science & Technology (Plasma-2015), Saha Institute of Nuclear Physics, Kolkata, India, 1-4 December 2015

The Influence of Distance between Cathodic Cage and the Specimens during Plasma Nitriding of Low Carbon Steel

G. Jhala, J. Alphonsa, A. Vaid, Rahul Patel, Naresh Vaghela, Keena Kalaria, S. Gupta, and S. Mukherjee won **Best Poster Award** at 30th National Symposium on Plasma Science & Technology (Plasma-2015), Saha Institute of Nuclear Physics, Kolkata, India, 1-4 December 2015

Effect of ion motion on relativistic electron beam driven wakefield phenomena in a cold plasma

Ratan Kumar Bera, Sudip Sengupta and Amita Das won **PSSI Poster Award** at 30th National Symposium on Plasma Science & Technology (Plasma-2015), Saha Institute of Nuclear Physics, Kolkata, India, 1-4 December 2015

Commissioning and Experimental Validation of SST-1 Plasma Facing Components

Yuvakiran Paravastu, Dilip Raval, Ziauddin Khan, Hiteshkumar Patel, Prabal Biswas, Tejas Parekh, Siju George, Prosenjit Santra, Gattu Ramesh Babu, Prashant Thankey, Pratibha Semwal, Arun

Prakash A, Kalpeshkumar R Dhanani, Snehal Jaiswal, Pradeep Chauhan, Subrata Pradhan won **Best Poster award** at 10th Asia Plasma & Fusion Association Conference (APFA-2015), Institute for Plasma Research, Gandhinagar, Gujarat, India, 14-18 December 2015

The Refurbishment of Damaged Toroidal Magnetic Field coils for Aditya Upgrade

Devraj H Sadharakiya, Rakesh L Tanna, Joydeep Ghosh, Prabal K Chattopadhyay, Sharvil Patel, Vaibhav Ranjan, Rohit Kumar, Harshita Raj, Krishnamachari Sathayanarayana, Madan B Kalal, Dinesh S Varia, Ramkrushna Panchal, Kulav Rathod, Shailesh B Bhatt, A Vardharajulu, Yogesh C Saxena, Dhiraj Bora, Shell-N-Tube Team won **Best Poster presentation award** at 10th Asia Plasma & Fusion Association Conference (APFA-2015), Institute for Plasma Research, Gandhinagar, Gujarat, India, 14-18 December 2015

A Study of Anomalous Transportation of Sawtooth Generated Runaway Electrons Observed in ADITYA Tokamak

Harshita Raj, Joydeep Ghosh, Rakesh L Tanna, Prabal K Chattopadhyay, Raju Daniel, Sameer Kumar Jha, Jayesh V Raval, Y Shankara Joisa, Shishir Purohit, C V S Rao, Umeshkumar C Nagora, Parveen Kumar Atrey, Malay Bikas Chowdhuri, Ranjana Manchanda, Yogesh C Saxena, Rabindranath Pal and Aditya Team won **Best Poster presentation award** at 10th Asia Plasma & Fusion Association Conference (APFA-2015), Institute for Plasma Research, Gandhinagar, Gujarat, India, 14-18 December 2015

Design Data for Quick Development of Folded E Plane Tee

Aviraj R. Jadhav, Yogesh M. Jain, Harish V. Dixit, Alice N. Cheeran, Vikas N. Gupta, P. K. Sharma won **Best Paper Award** at 12th IEEE India International Conference, INDICON 2015, Jamia Millia Islamia, New Delhi, 17-20 December 2015

Dr. Mukesh Ranjan (Scientist-SF, FCIPT/IPR), was awarded **Young Achiever Award** in the Golden Jubilee 60th DAE Solid State Physics Symposium held at Amity University, Uttar Pradesh, Noida, 21-25 December 2015. The award has been conferred

recognizing his scientific contributions in the field of plasma material interaction.

E 4. Invited Talks Delivered By IPR Staff

DHIRAJ BORA

Gave an Invited talk on “Indian Initiatives in Magnetically Confined Fusion Research”, at 7th International Conference on the Frontiers of Plasma Physics and Technology (FPPT-7), Kochi, India, 13-17 April 2015

Gave an Invited talk on “Thermo-Nuclear Fusion: A Unique Alternate Source of Energy, Saha Institute of Nuclear Physics Colloquium, Kolkata, 28 May 2015

Gave an Invited talk on “Challenges in Material Development for fusion Reactors and India’s Initiatives” at Nanoscale Excitations in Emergent Materials (NEEM 2015), Rome, Italy, 12-14 October 2015

Gave an Invited talk on “My Experiences at ITER” in Hindi at Institute for Plasma Research, Gandhinagar, on 6 November 2015

DEBASIS CHANDRA, ANANTANARAYANAN THYAGARAJA, ABHIJIT SEN and PREDHIMAN KAW

Gave an Invited talk on “Simulations of ELMS in Presence of RMPs using CUTIE Code” at 7th INTERNATIONAL CONFERENCE ON THE FRONTIERS OF PLASMA PHYSICS AND TECHNOLOGY (FPPT-7), Kochi, India, 13-17 April 2015

SANJEEV VARSHNEY

Gave an Invited talk on “Current X-ray Crystal Spectroscopy developments for ITER” at 3rd International conference on optical and photonics engineering (icOPEN-2015), Singapore Expo, Singapore, 14-16 April 2015

Gave an Invited talk on “Shielding Requirements

and Design, Analysis for ITER XRCS Systems” at INS National Workshop on Radiation Shielding Design and Analysis, AERB Auditorium, Niyamak Bhavan, Anushaktinagar, Mumbai, 10-14 August 2015

SUBRATA PRADHAN

Gave an Invited talk on “Experiments and Up-gradation Status in SST-1” at 8th IAEA Technical Meeting on Steady State Operation of Magnetic Fusion Devices, Nara, Japan, 27 May 2015

P. K. SHARMA

Gave an Invited talk on “Application of High Power CW microwave power in fusion Research” at One day meet on Scientific Applications of High Power Microwave Tubes, CSIR-CEERI, Pilani, Rajasthan, 22 May, 2015

Gave an Invited talk on “Development activities in high power CW LHCD system” at a Workshop on Indian Innovations in Materials Research: New Materials and Processes (IIMR-2015), CSIR-CGCRI, Kolkata, 25-27 June 2015

RENU BAHL, B.SARKAR, ANURAG SHYAM

Gave an Invited talk on “Physics Design of 1MeV Radio Frequency Quadrupole (RFQ) at IPR” at Workshop on RFQ Accelerators and Associated Technologies, IPR, Gandhinagar, 9-10 June 2015

SARVESHWAR SHARMA, S K MISHRA, P K KAW, A DAS, N SIRSE, M M TURNER

Gave an Invited talk on “Collisionless Sheath Heating in CCP Discharges Due to Higher Order Sinusoidal Signals” at NCPST 5th Radio Frequency Discharge Workshop, National Centre for Plasma Science & Technology, Dublin City University, Ireland, 22-23 June 2015

Gave an Invited talk on “Stochastic Sheath Heating Phenomenon in Capacitive Discharges Due to Higher Order Sinusoidal Signals” at Indo-Taiwan Low Temperature Plasma Physics collaborative work meeting, Aerothermal & Plasma Physics

Laboratory, National Chiao Tung University, Hsinchu, Taiwan, on 24 March 2016

S. K. KARKARI

Gave an Invited talk on “Overview of Basic Experiments in APPEL Device” at 5th International Radio Frequency Discharge Workshop, National Centre for Plasma Science & Technology, Dublin City University, Ireland, 22-23 June 2015

S. K. NEMA

Gave an Invited talk on “Waste Disposal and Energy Recovery using Thermal Plasma Technology” at Recent Trends in Mechanical Engineering Workshop, Mechanical Engineering Department, Government Engineering College, Bhavnagar, 22 June 2015

Gave an Invited talk on “Defining the Research Problem-Objectives-Motivation” at TEQIP-II Workshop on Research Methodology –GEC, Gandhinagar, 6-10 July 2015

Gave an Invited talk on “Introduction to Plasma Processing” at a workshop on Applications of cold plasmas in surface engineering, FCIPT, IPR, 11 September 2015

Gave an Invited talk on “Alternative energy solutions using plasma technologies” at International workshop on Advanced Materials Challenges for Alternative Energy Solutions AMAES-III, New Delhi, 18 -19 December 2015

Gave an Invited talk on “Plasma surface modification of natural and synthetic polymers” at Advancements in Polymeric Materials (APM 2016), CIPET, Ahmedabad, 12-14 February 2016

Gave an Invited talk on “Plasma Technologies for Societal benefits developed at FCIPT” at TEQIP workshop on Advances in Surface Engineering & Welding Technology, FCIPT, IPR, 29 February-1 March 2016

BHARAT DOSHI

Gave an Invited talk on “Design and Manufacture of ITER Cryostat” at Workshop on “Design and Fabrication of Accelerator & ITER components”, Indian Nuclear Society, AERB, Mumbai, 06th July 2015

MUKESH RANJAN

Gave an Invited talk on “Silver Nanoparticles on GaSb Nanodots: a LSPR-boosted Binary Platform for Broadband Light Harvesting and SERS” at 8th International Workshop on Nanoscale Pattern Formation at Surfaces, Krakow, Poland, 12-16 July 2015

Gave an Invited talk on “Plasma Technologies in Space Applications” at One Day Seminar about Frontier in Space Science, LDRP College of Engineering, Gandhinagar, 25 July 2015

Gave an Invited talk on “Investigation of Growth of Silver Atoms on Patterned Substrate” at Nanoscale Excitations in Emergent Materials (NEEM 2015), Rome, Italy, 12-14 October 2015

Gave an Invited talk on “Plasma Flux dependence on pattern formation at normal incidence” at REI-2015, Jaipur, 26-31 October 2015

Gave an Invited talk on “Mechanism of Self-Assembly and Plasmonic Coupling in Dense Nanoparticles Arrays Grown On Plasma Produced Templates” at 60th DAE Solid State Symposium, Amity University, Uttar Pradesh, Noida, 21-25 December 2015

Gave an Invited talk on “Dense nanoparticles arrays for photovoltaic and plasmonic sensor” at Nano-scaled system for Energy Harvesting, VIT University, Chennai, 1-3 February 2016

Gave an Invited talk on “Advanced Characterizations techniques for Nanotechnology” at workshop on Characterization Techniques for Materials (CTM-2016), Sardar Patel University, 23-24 February 2016

Gave an Invited talk on “Plasma based techniques for nanopatterning, nanoparticle and its applications”

at Seminar on Plasma Based Technologies, Gujarat Technical University, Ahmedabad, 5 March 2016

S MUKHERJEE

Gave an Invited talk on “Environment Friendly Plasma Technologies: Developments at Institute for Plasma Research” at PSSI-Plasma Scholars’ Colloquium, Jadhavpur University, Kolkata, 6-7 August 2015

Gave an Invited talk on “Industrial Plasma Applications - Recent Developments in FCIPT” at International Conference on Plasma Science, Technology & Application (ICPSTA-2016), Amity University, Lucknow, 20-21 January 2016

NIRAV I. JAMNAPARA

Gave an Invited talk on “Role of Coatings in Energy Systems” at TEQIP-II seminar on ‘Recent Advances in Mechanical Engineering’ organized by Government Engineering College, Bhavnagar, 22 June 2015

Gave an Invited talk on “Effective Scientific and Technical Communication in form of presentation”, at the ‘Workshop on Research Methodology’ organized by Government Engineering College, Gandhinagar, 10 July 2015

Gave an Invited talk on “Overview of Eco-Friendly Processing of Polymers using Plasma Technology” at Polymer processing, reclamation and its end-of-life impact on environment, IEI Gujarat State Centre, Bhaikaka Bhavan, Law garden, Ahmedabad, 22 August 2015

Gave an Invited talk on “Coatings for High Temperature Applications” at Department of Metallurgical & Materials Engineering, Indus University, Ahmedabad, 20 October 2015

Gave an Invited talk on “Materials and process developments for enhancing energy efficiency and performance of gas turbine systems” at Indo-German workshop on “Advanced Materials Challenges for Alternative Energy Solutions”, The Park Hotel, New Delhi, 17-19th December 2015

Gave an Invited talk on “Bio medical Applications of Plasma Technology” at 13th National conference and Technology exhibition on “Indian medical devices and plastics disposables/implants industry 2016”, AMA, Ahmedabad 12-13 February 2016

Gave an Invited talk on “Collaborative R&D on plasma technologies and funding opportunities”, at a Seminar on Plasma Technologies organized by GTU, Chandkheda, Ahmedabad, 5 March 2016

J. ALPHONSA

Gave an Invited talk on “Plasma Nitrocarburizing Process - A Solution to Improve Wear and Corrosion Resistance” at Symposium on Water Chemistry and Corrosion in Nuclear Power Plants in Asia – 2015, Anupuram, IGCAR, India, 2-4 September 2015

Gave an Invited talk on “Surface hardening by Plasma nitriding process” at a Workshop on Applications of Cold Plasmas in Surface Engineering, FCIPT, IPR, 11 September 2015

PURVI DAVE

Gave an Invited talk on “Plasma Surface Modification of Polymers” at workshop on ‘Applications of cold plasma in surface engineering’, FCIPT, IPR, 11 September 2015

Gave an Invited talk on “Scanning Electron Microscopy & FTIR Analysis” at TEQUIP II Sponsored workshop on ‘Recent Trends in Instrumentation’, GEC, Gandhinagar, 22 January 2016

SURYAKANT B. GUPTA

Gave an Invited talk on “Environmental protection using Plasma technology”, at Hindi Day Celebrations, Bhabha Atomic Research Centre, Tarapur, 14 September 2015

M. RANJAN and S. AGRAWAL

Gave an Invited talk on “Plasmonics Incorporated CZTS Solar Cell” at DST-UKIERI Indo-UK Workshop, New Delhi, 21 September 2015

P. A. RAYJADA

Gave an Invited talk on “Energy and Nuclear Fusion: Challenges from Materials” at INSPIRE Internship Science Camp-2015, Dept. of Science and Technology, Amreli, Gujarat, 5-9 May 2015

Gave an Invited talk on “Energy Thirst & Nuclear Fusion: Promises & Challenges” at Shri Adani Vidya Mandir’s Event on Inspiring the Students for Studying Science, Shri Adani Vidya Mandir, Makarba, Ahmedabad, 28 September 2015

Gave an Invited talk on “Er₂O₃ Coating Process and Characterization: Nuclear Fusion Reactor Perspective” at First International Conference on Advanced Materials for Power Engineering (ICAMPE-2015), Kottayam, India, 11-13 December 2015

DEEPAK AGGARWAL

Gave an Invited talk on “Neutronic Activities in Test Blanket Module Division (TBMD) IPR” at DAE-BRNS Workshop on Monte Carlo Neutron transport Code (MONC), Bhabha Atomic Research Centre, Mumbai, 9 October 2015

INDRANIL BANDYOPADHAY

Gave an Invited talk on “The update of the ITER Halo current modelling activity of the ITPA MHD Working Group” at ITPA MHD meeting, Napoli, Italy, October 2015

Gave an Invited talk on “The update of the ITER Halo current modelling activity of the ITPA MHD Working Group” at ITPA MHD meeting, NIFS, Japan via Video Conferencing, March 2016

NISHA CHANDWANI

Gave an Invited talk on “Plasmas for Eco-friendly Textile Processing” at Seminar of the Association of Chemical Technologist India (ACTI), Navrangpura, Ahmedabad, 31 October 2015

Gave an Invited talk on “Plasmas for Textile Processing” at Gujarat Technological University

(GTU), 5 March 2016

BISWANATH SARKAR

Gave an Invited talk on “ITER Cryo-distribution and Cryoline project - an Effort for Enhanced Reliability through R & D” at 8th Asian Conference on Applied Superconductivity and Cryogenics 2015 Conference, Zhejiang University, Hangzhou, China, 23 November 2015

J. ALPHONSA, G. JHALA, S.B. GUPTA, S. MUKHERJEE

Gave an Invited talk on “Plasma Nitriding- A case study of journey from laboratory to industry” at 5th Annual Quality Conference, Nirma University, Ahmedabad, 26 November 2015

S.S. KAUSIK, B. KAKATI, D. KALITA, B.K. SAIKIA, and M. BANDYOPADHYAY

Gave an Invited talk on “Conceptual design of an extraction system for a surface assisted volume negative hydrogen ion source” at 16th Workshop on Fine Particle Plasmas, National Institute for Fusion Science, Toki city, Gifu, Japan, 10-11 December 2015

MRITYUNJAY KUNDU

Gave an Invited talk on “On the collisionless absorption in laser driven over-dense plasmas” at ASHULA Grand Seminar/Symposium-2016, Osaka University, Japan, 5-7 January 2016

S.S. KHIRWADKAR

Gave an Invited talk on “Overview of the R&D work being carried out at Divertor and Firstwall Technology Development Division of IPR” at Workshop on interaction between IPR and Pandit Deendayal Petroleum University (PDPU, Gandhinagar), 11 January 2016

UJJWAL K BARUAH

Gave an Invited talk on “Fusion Activities: Update from India” and “Gaps Analysis of Strategic Research Priorities in Support of DEMO: Indian

Scenario” at Annual meeting of International Energy Agency (IEA), Fusion Energy Coordination Committee (FPCC), IEA Headquarters, Paris, 27-28 January 2016

K.S. GOSWAMI

Gave an Invited talk on “Energy for future” at Kaziranga University, Jorhat, 29 February 2016

Gave an Invited talk on “Erosion due to ion sputtering in absence of Debye Sheath at Divertor Plasma” at the “National conference on Emerging Trends in Physics of Fluids & Solids (NCETPFS)”, Jadavpur University, Kolkata, 3-4 March 2016

S. SHRAVAN KUMAR

Gave an Invited talk on “Universal Decimal Classification Scheme (UDC): Theory and Practice” to M.L.I.Sc. Students of Central University of Gujarat, Gandhinagar, 12 March 2016

GAUTAM C SETHIA

Gave an Invited talk on “Chimera states: the hype versus the facts” at 4th International Conference on Complex Dynamical Systems and Applications, at National Institute of Technology, Durgapur, India, 15-17 February 2016

S.V. KULKARNI and RF GROUP

Gave an Invited talk on “Development of High Power RF and Microwave Sources using Klystrons, Gyrotrons and Tetrodes for Fusion Reactors” at Thapar University, Patiala, on 30 March 2016

ZIAUDDIN KHAN

Gave an Invited talk on “Challenges and the latest progress in LIGO-India project” at Theme meeting on New Horizons for Vacuum Technology, Institute for Plasma Research, Gandhinagar, 31 March 2016

Invited talks given at 30th National Symposium on Plasma Science & Technology (Plasma-2015), Saha Institute of Nuclear Physics (SINP), Kolkata, India, 1-4 December 2015

ABHIJIT SEN gave a Keynote Address on “Indian Fusion Program: The Road Ahead”

SHISHIR DESHPANDE gave a Popular talk on “Why We Can Not Avoid the Failure to develop Human Resource”

AMITADAS and SST1 Team gave an Invited talk on “SST 1: The Indian Steady State Superconducting Tokamak”

R.L. TANNA and the ADITYA Team gave an Invited talk on “Recent Advances in Aditya Tokamak Operation and experiments”

R. SRINIVASAN and the Indian DEMO Team gave an Invited talk on “Progress on Design of SST-2 Fusion Reactor”

A. K. CHAKRABORTY, NIST Team and DNB Team gave an Invited talk on “R & D on Negative Ion Neutral Beams for Fusion devices - Indian Contribution”

S. MUKHERJEE and FCIPT Team gave an Invited talk on “Plasma Nitriding - An Eco Friendly Surface Hardening Process”

MRITYUNJAY KUNDU gave an Invited talk on “Anharmonic Resonance Absorption of Laser Pulses in Over-Dense Plasmas”

ASHWIN JOY gave an Invited talk on “Hydrodynamic Instabilities & Relaxation in a Model Visco-elastic Liquid”

UMESH KUMAR, T.S. GOUD, R. GANESH, D. RAJU, Y.C. SAXENA gave an Invited talk on “Role of Magnetic Field Topology in a Simple Toroidal Plasma - Issues, Diagnostics and Solutions”

Y. SHANKARA JOISA gave an Invited talk on “X-Ray Diagnostics for Tokamak Physics”

P. BHARATHI gave an Invited talk on “Overview of Beam Based Spectroscopy Techniques for Measurements in Fusion Plasma Research”

I. BANDYOPADHYAY gave an Invited talk on

“Disruption Modelling in Support of ITER”

Invited talks given at 10th Asia Plasma & Fusion Association Conference (APFA-2015), Institute for Plasma Research, Gandhinagar, Gujarat, India, 14-18 December 2015

DHIRAJ BORA gave an Invited talk on “Fusion Research in India”

SHISHIR DESHPANDE gave an Invited talk on “ITER India R & D and ITER Package Progress”

SUBRATA PRADHAN, ZIAUDDIN KHAN, VIPUL L TANNA, DILIP RAVAL, UPENDRA PRASAD, HARISH MASAND, AVEG KUMAR, KIRITKUMAR B PATEL, MANISHA BHANDARKAR, JASRAJ DHONGDE, BRAJ KISHORE SHUKLA, IMRAN MANSURI, YOHAN KHRISTI, YUVAKIRAN PARAVASTU, CHET NARAYAN GUPTA, DINESH SHARMA, KALPESHKUMAR R DHANANI, PRATIBHA SEMWAL, SIJU GEORGE, SUBRATA JANA, PRADIPPANCHAL, ROHITKUMAR PANCHAL, RAKESHKUMAR PATEL, HITESH KUMAR GULATI, KIRTI MAHAJAN, MOHAMMAD SHOAIB KHAN, PRASHANT THANKEY, AZADSINH MAKWANA, GAURANG MEHSURIYA, PRADEEP CHAUHAN, ARUN PARKASH A, MURTUZA VORA, AKHILESH SINGH, DASHRATH SONARA, PANKAJ VARMORA, G SRIKANTH, DIKENS CHRISTIAN, ATUL GARG, ARUN PANCHAL, NITIN BAIRAGI, MANIKA SHARMA, GATTU RAMESH BABU, PROSENJIT SANTRA, TEJAS PAREKH, HITESHKUMAR PATEL, PRABAL BISWAS, SNEHAL JAYSWAL, TUSHARKUMAR RAVAL, HITESHKUMAR CHUDASAMA, ATISH SHARMA, AMIT OJHA, BHADRESH R PRAGHI, MONI BANAUDHA, KETAN PATEL, HIREN NIMAVAT, PANKIL SHAH, JAYANT C PATEL, RAJIV SHARMA, A VARADHARAJULU, RANJANA MANCHANDA, PARVEEN KUMAR ATREY, SURYA KANTH PATHAK, Y SANKAR JOISA, KUMUDNI TAHILIANI, MANOJ KUMAR, SANTANU BANERJEE, DEBASHIS GOSH, BHOOMI CHAUDHARY, AMITA DAS, DHIRAJ BORA gave an Invited talk on “Initial Results in

SST-1 After Up-gradation”

RAJU DANIEL, P MOREAU, MANISHA BHANDARKAR, SBREMOND, JBUCALOSSO, VISHNU K CHAUDHARI, X COURTOIS, JASRAJ DHONGDE, C GIL, AVEG KUMAR, PRAVEENA KUMARI, M LEWERENTZ, P LOTTE, IMRAN MANSURI, HARISH MASAND, O MEYER, M MISSIRLIAN, E NARDON, R NOUAILLETAS, KIRITKUMAR B PATEL, SUTAPA RANJAN, C RAPSON, G RAUPP, N RAVENEL, F SAMAILLE, MANIKA SHARMA, J SIGNORET, A SPRING, J M TRAVERE, W TREUTERRER, A WERNER, WEST TEAM gave an Invited talk on “Measurements and Controls Implementation for the WEST Project”.

E 5. Talks Delivered By Distinguished Visitors At IPR

Dr. B. B. Nayak, Institute of Minerals & Materials Technology (IMMT), Bhubaneswar, gave a talk on “Preparing nanotube bundles by plasma method: approach for evaluation and application”

Prof. Prabhat Ranjan, Executive Director, Technology Information, Forecasting and Assessment Council (TIFAC), Delhi, gave a talk on “Glimpse of TIFAC activities”

Dr. Pamidi Sastry, Principal Investigator and Lead Scientist of Superconductivity and Cryogenics Laboratory, Center for Advanced Power Systems, Florida State University, USA, gave a talk on “Current R&D Activities at the Florida State University Center for Advanced Power Systems in Superconducting Power Devices”

Dr. Arvind Saxena, Director, Defence Materials Research & Development Establishment (DMSRDE), Kanpur, gave a talk on “Precursor Material for High Temperature Application”

Dr. V P Singh, Chief Scientist, CEERI, Pilani, gave a talk on “R&D activities on RF Windows at CSIR-CEERI Pilani” on 14th July 2015

Dr. Rohit Kumar, University of Allahabad, Uttar Pradesh, gave a talk on “Study of Toxic Elements in Environmental Samples Collected from Industrial Area using Spectroscopic Techniques”

Dr. A. Sivathanu Pillai, ex CMD BrahMos, gave a talk on “Technology Leadership”

Dr. Dattatray Shinde, S. N. Bose National Centre for Basic Sciences, Kolkata, gave a talk on “Investigation of Granular and Cognitive Complex Systems”

Shri.M.V.Dhekane, Associate Director, R&D, Vikram Sarabhai Space Centre (VSSC), Thiruvananthapuram, Kerala, gave a talk on “Introduction of FEAST (Finite Element Analysis of Structures)”

Dr. Jayakumar, Vikram Sarabhai Space Centre (VSSC), Thiruvananthapuram, Kerala, gave a talk on “Overview of PreWin/FEAST Software”

Dr. Archana Lakhani, Scientist, UGC-DAE Consortium for Scientific Research, Indore, gave a talk on “Temperature and Magnetic Field Induced Effects on Functional Magnetic Materials”

Dr. Animesh Kuley, University of California, California, USA, gave a talk on “Electromagnetic particle simulation of linear mode conversion of lower hybrid waves and parametric decay instability of ion cyclotron waves in tokamak”

Prof. Tomas J. Dolan, University of Illinois, USA, gave a talk on “Fusion-fission Hybrid Reactors”

Dr. Prashant Sharma, Indian Institute of Technology Kharagpur, gave a talk on “Development of Coating for Hot Corrosion Resistance of AISI 304 Stainless Steel and High Temperature Oxidation Resistance of Inconel 718”

Prof. Tomas J. Dolan, University of Illinois, USA, gave a talk on “Molten Salt Reactors and Thorium Energy”

Prof. Tomas J. Dolan, University of Illinois, USA, gave a talk on “Plasma Heating and Current Drive”

Prof. Tomas J. Dolan, University of Illinois, USA, gave a talk on “How to Give Good Technical Presentations”

Dr. Kailash Chandra Meher, Bhabha Atomic Research Centre, Mumbai, gave a talk on “Study of Thermal, Electrical and Fluid Dynamic Behaviour of Arc Plasma Devices”

Dr. Ketan D. Patel, Zydus Hospitals, Ahmedabad, gave a talk on “Medical Emergency Management”

Dr. Rameswar Singh, Laboratoire de Physique des Plasmas, France, gave a talk on “Geodesic acoustic modes with poloidal mode couplings ad infinitum”

Dr. Vikrant Saxena, Centre for Free Electron Laser Science, Germany, gave a talk on “X-ray Irradiation of Finite Systems: Modeling the Nanoplasma Dynamics”

Dr. Shashank Rathod, Eye Care Hospital, Ahmedabad, gave a talk on “Total Eye Care-Take care of your Eyes”

Dr. Jitendra Kumar, Birla Institute of Technology & Science, Pilani, Rajasthan, gave a talk on “Design and Analysis of Dielectric Resonator Antenna”



(DRA) for Wideband Applications”

Dr. Nitya Hariharan, Intel Technology Private Ltd, Bangalore, gave a talk on “High Performance Computing (HPC) – Applications in Computational Physics”

Dr. Huw Leggate, Dublin City University, Ireland, gave a talk on “Studies into capacitively coupled plasmas in the presence of grazing angle magnetic fields”

Dr. Robert Pearce, ITER Vacuum Section, ITER Organization, Cadarache, France, gave a talk on “An overview of the ITER vacuum Systems and practices”

Shri K. Ramprasad, Head, Industrial Plants Safety Division, Atomic Energy Regulatory Board, Mumbai, gave a talk on “Safety Culture for R&D organizations”

Shri Rajnikant Sharma, Sr. Manager (Fire & Safety), Indian Farmers Fertiliser Cooperative Limited, Kalol, Gujarat, gave a talk on “Behavioral Management of Safety”

Shri Ajit Kumar, Nuclear Power Corporation of India Ltd., Kakrapar, Gujarat, gave a talk on “Nuclear Power Program and Safety”

Dr. A.K.Patra, Head, Environmental Survey Laboratory, Bhabha Atomic Research Centre, Mumbai, gave a talk on “Radiation - A fact of life and Environmental Impact Assessment around KAPS”

Dr. Hogun Jhang, National Fusion Research Institute (NFRI), South Korea, gave a talk on “Influence of zonal flows on dynamical processes in tokamak plasmas: Results from turbulence

simulations”

Dr. Jae Min Kwon, National Fusion Research Institute (NFRI), South Korea, gave a talk on “Status of gyrokinetic simulation studies in NFRI”

Dr. R. Singh, National Fusion Research Institute, Korea, gave a talk on “Particle transport in core and pedestal of tokamak plasmas”

E 6. Colloquia Presented At IPR

Prof. S P Sukhatme, Professor Emeritus, IIT Bombay, on “Estimating India’s Future Needs of Electricity” (Colloquium # 249)

Prof. P. K. Kaw, DST Year of Science Professor at Institute for Plasma Research, Gandhinagar, on “Tokamak Physics: Brief Overview and A Perspective” (Colloquium # 250)

Prof. Cary B Forest, Department of Physics, University of Wisconsin, Madison, USA, on “Chasing Fast Dynamos in the Plasma Lab and Other Pursuits” (Colloquium # 251)

Prof. R.B. Sharma, Scientist, DRDO, Delhi & Adjunct Faculty, DIAT, Pune, on “Field emission/ion microscopy: Principle and applications” (Colloquium # 252)

Prof. Kajari Mazumdar, Department of High Energy Physics, Tata Institute of Fundamental Research, Mumbai, on “The Unbelievable Pursuit of the Unimaginable” (Colloquium # 253)

Prof. Bikas K. Chakrabarti, Senior Professor, Saha Institute of Nuclear Physics (SINP), Kolkata, on “Econophysics of Income & Wealth Inequalities” (Colloquium # 254)

Prof. Amitava Gupta, Jadavpur University, Kolkata, on “Control Over Data Networks-Issues, Challenges, Tools and Techniques” (Colloquium # 255)

Dr. Kushal Shah, Electrical Engineering Dept, IIT Delhi, on “Fermi acceleration in billiards with holes” (Colloquium # 256)

Dr. Shankar Mahadevan, Esgee Technologies Inc., Texas, U.S., on “Simulation of non-equilibrium and equilibrium plasma discharges for industrial application” (Colloquium # 257)

Dr. Purushothama Chippar, Mechanical Engineering Department, St. Joseph Engineering College, Mangalore, Karnataka, on “Design and Optimization of Metal Hydride Vessels for Hydrogen/Tritium Storage and Transportation via experiments and numerical modeling” (Colloquium # 258)

E 7. Scientific Meetings Hosted By IPR

10th IAEA Technical Meeting on Control, Data Acquisition, and Remote Participation for Fusion Research, IPR, Gandhinagar, 20-24 April 2015

The 10th IAEA Technical Meeting on Control, Data Acquisition and Remote Participation for Fusion Research was organized by IPR during 20-24 April 2015. The topics covered in this meeting were ; Plasma Control, Machine Control, Monitoring, Safety and Remote Manipulation, Data Acquisition and Signal Processing, Database Techniques for Information Storage and Retrieval, Advanced Computing and Massive Data Analysis, Remote Participation and Virtual Laboratory, Fast Network Technology and its Application etc. Of the 130 delegates who participated in this meeting, around 50 were from various international institutions.

Workshop on RFQ Accelerators and Associated Technologies, Institute for Plasma Research, Gandhinagar, 9-10 June 2015

Workshop on Applications of Cold Plasma for Surface Engineering, IPR, FCIPT Gandhinagar, 11th September 2015

A one-day workshop on “Applications of cold plasma for surface engineering” was held in FCIPT on 11th September 2015. The workshop was initially inaugurated by Prof. Dhiraj Bora (Director, IPR) and Shri. R. N. Raval (Joint Commissioner of Industries, MSME) in the morning session followed by different talks delivered by the scientists on surface modification technologies based on cold plasmas. The seminar was attended by 36 participants from different industries mainly from polymer based, machinery manufacturing, Textile industries like MANTRA, WRA, ACTI, Dentists, Medical device dealers, Doctors from Medical organizations and research scholars from ICT, Mumbai. During the workshop, various topics on ranging from agriculture to machinery were discussed. After the first session, a visit to FCIPT was arranged for the delegates, where three technologies developed by FCIPT were demonstrated to them i.e., Plasma nitriding, Plasma jet and high density plasma for textile applications. After the workshop, many industries expressed their interest in working with FCIPT on newer technologies like atmospheric plasma jet for medical application, enhancement of germination rate with plasma, textiles, etc.

Research Scholar’s Meet: Electronics & Communication Engineering, IPR, Gandhinagar, 5 November 2015

A “Research Scholars’ Meet” for the faculty members pursuing their PhD in EC Engineering

in various institutions in Gujarat was organized on 5th November, 2015 at IPR. The event was coordinated by Dr.-Ing. Suryakant Gupta of IPR and Dr. R. A. Thakker (Research Coordinator – SPFU and Prof. EC, VGEC – Chandkheda). There are good number of faculty from Engineering Colleges of Gujarat State pursuing their PhD and doing research work in the area of Electronics and Communication Engineering. These faculty members work independently and they have very limited opportunities to interact among them-selves or get exposed to state-of-the-art technologies. With the tremendous growth in the field of Electronic and Communication, is it essential that these researchers are provided some kind of a platform for interaction and discussion. In this one-day event, the welcome speech was given by Prof. Dr. S. Mukherjee of IPR. Prof. Usha Neelkanthan (SPFU Co-ordinator) presented about SPFU and TEQIP research strand activities. Dr. N. M. Devashryee (Prof. EC, Nirma University) gave a talk on research methodology. Dr. Mekie Joycee of IIT Gandhinagar discussed about the recent trends in multi-core architecture. Prof. Chirag Paunwala (SCET – Surat) and Prof. J. N. Sarvaiya (SVNIT – Surat) delivered interesting talks on research opportunities in Image Recognition and Registration, respectively. Six PhD scholars: Amit Rathod, Haresh Judal, Avani Vithalani, Shahid Modasiya, Sandip Dawda and C. R. Parekh delivered oral presentation about their ongoing PhD work. More than 40 ME students of few nearby engineering colleges also attended the event. Mr. Amit Srivastava of IPR discussed the avenues for EC Engineers in IPR. The vote of thanks and summary of event was delivered by Dr. R. A. Thakker.

Technology Transfer Meet: Plasma technologies - Available for industries, FCIPT, Institute for Plasma Research, 11 December 2015

Tech-Transfer Meet was organized at FCIPT, Institute for Plasma Research, on 11 December 2015, with an objective to interact with the industries who are interested in making commercial use of plasma based green technologies. These are low cost indigenously developed plasma technologies which may be useful to various industrial sectors like Automobiles, Metal, Polymers, Medical Devices & Machinery manufacturing.

10th Asia Plasma and Fusion Association Conference (APFA - 2015), IPR, Gandhinagar, 14-18 December 2015

LabVIEW Training, IPR, Gandhinagar, 11-15 January 2016

Considering the large number of users for LabVIEW in IPR, ITER-India and FCIPT, a five day, hands-on training for LabVIEW was organized at IPR seminar hall during 11-15 January 2016. 30 employees were trained for LabVIEW Connectivity, Data Acquisition and Signal Conditioning, Real Time and for FPGA. Actual applications from different groups were discussed and implemented. During the training, participants also were given hands-on training on real time and FPGA using training kits

PLC Training, IPR, Gandhinagar, 1-9 February 2016

A training program for TIA (Totally Integrated Automation) with S7-300 & STEP7 training of SIEMENS PLC was organized in IPR Feb 1-9, 2016. There were 12 IPR staff from different groups who participated in this training session, which also has hands-on sessions. Different topics including STEP7 programming language, Configuration of system, Analog and digital input & output accessing methods and communication protocols (Industrial Profibus, Profinet, Ethernet)

with remote devices. An introduction to HMI and Drive for automation and control was also given to the participants. Actual scenario of different plants and control applications were also discussed with experts from SEIMENS during the course of the training.

Workshop on Advances in Surface Engineering and Welding Technology, FCIPT, IPR, Gandhinagar, 29 February 2016 - 1 March 2016

A 2-day workshop on ‘Advances in Surface Engineering and Welding Technology’ organized jointly by IPR, Govt. Engg. College Gandhinagar and ASM International Gujarat Chapter was conducted at FCIPT on 29th Feb, 2016 and 1st March, 2016. IPR is a mentoring organization to 7 TEQIP-II colleges of Govt. of Gujarat under a MoU between IPR and Commissionerate of Technical Education, Gandhinagar. The workshop was attended by faculty and students of GEC Gandhinagar, researchers from PDPU, IIT Gandhinagar and industry representatives. The International speakers profile included Dr. Zoltan Kolozsvary, Managing Director, SC Plasmaterm SA, Romania; Dr. T. Sudarshan, CEO - Materials Modification Inc, USA and Trustee - ASM International; and Prof. Antonello Astarita, Faculty - University of Naples ‘Federico-II’, Italy, while local speakers included Dr. S. K. Nema from FCIPT, IPR and Prof. Vishvesh Badheka from PDPU. The workshop witnessed enhancement in networking amongst the participants and with the speakers and opened areas for mutually beneficial research environment.

Seminar on Plasma Technologies @ GTU, 5 March 2016

A one-day seminar on Plasma based Technologies was jointly organised by FCIPT/IPR and

Research and Consultancy Services Cell, Gujarat Technological University (GTU) in association with PG Research Centre for Governance Systems, GTU on 5th March. Prof. D. Bora, Director IPR gave the Guest of honour speech followed by Keynote talks by Dr. S. Mukherjee and Dr. S. Nema. Various plasma based technologies were discussed for waste disposal, textile, automobile and nanotech-nology applications in the talks of Ms. Alphonsa, Ms. Nisha Chandwani, Dr. Mukesh Ranjan and Dr. Nirav Jamnapara. The faculty from GTU as well as the students actively participated in this event.

ITPA Meeting, IPR, Gandhinagar, 16-18 March 2016

The International Tokamak Physics Activity (ITPA) provides a framework for internationally coordinated fusion research activities. The ITPA operates under the auspices of ITER. The meetings of the International Tokamak Physics Activity (ITPA) - Transport & Confinement (T&C) and Pedestal & Edge Physics (P&EP) task groups were held at the Institute for Plasma Research (IPR) from 16th to 18th March 2016. Around thirty participants from different countries such as USA, EU, Japan, South Korea and India attended the meetings. Many attendees also participated in this meeting via video conferencing. Both the meetings were highly successful and many important presentations and fruitful discussions were held during the course of the meetings.

A theme meeting on “New Horizons for Vacuum Technology” IPR, Gandhinagar, 31 March 2016



E.8 MoU Signed

E.8.1 NATIONAL MoU SIGNED

Technology Transfer agreement:

FCIPT division's efforts in commercialization of plasma based home grown technologies resulted in the non-exclusive technology transfer agreement between IPR and M/s Therelek Engineers, Bangalore for Plasma Nitriding Technology. With the national programme on 'Make-in-India' basis, this technology will be a value addition to Indian Manufacturers and heat treaters for competing with international markets.

IPR – GIFT CITY CONTRACT:

The Institute for Plasma Research through its FCIPT division entered into a technical consultancy agreement with GIFT City, Gandhinagar for setting up of a prototype scale plasma pyrolysis system for solid waste management of GIFT City. GIFT City is India's first smart city project and plasma pyrolysis technology will be demonstrated for its competence for the said objective.

E.8.2 INTERNATIONAL MoU SIGNED

Specific Task of Cooperation (STC#5) agreement signed between IPR and CEA on 04/02/2016 to work on advanced diagnostics - development and implementation of XICS diagnostics for WEST

--!!!--